

The electropumps N, B-N, N4, B-N4 series comply with the European Regulation no. 547/2012.

## Materials

Components	N, N4 Mechanical seal	N, N4 Stuffing box	B-N, B-N4 Mechanical seal
Pump casing	Cast iron		Bronze
Casing cover	GJL 200 EN 1561		G-Cu Sn 10 EN 1982
Impeller	Cast iron		Bronze
	GJL 200 EN 1561		G-Cu Sn 10 EN 1982
	Brass P- Cu Zn 40 Pb 2 UNI 5705 For 32-125, 32-160, 32-200, 40-200		
Shaft	Chrome steel 1.4104 EN 10088 (AISI 430)	Carbon steel C 40 UNI 7845	Cr-Ni-Mo steel 1.4401 EN 10088 (AISI 316)
Shaft sleeve	–	Bronze G-Cu Sn5 Zn5 Pb5 EN 1982 with chromate surface	–
Mechanical seal	Carbon - Ceramic - NBR	–	Carbon - Ceramic - NBR
Counter-flanges	Steel Fe 430B UNI 7070		

## Construction

Single-stage end-suction centrifugal pumps, with bearing bracket.

Nominal duty points and main dimensions in accordance with EN 733. Back Pull-Out construction, for simple and quick dismantling and reassembly.

N, N4: version with pump casing and lantern bracket in cast iron.  
B-N, B-N4: version with pump casing and lantern bracket in bronze.  
(the pumps are supplied fully painted).

Rated speed of rotation (50 Hz): **N** ≈ 2900 rpm.  
**N4** ≈ 1450 rpm.

**Connections:** PN 10 flanges EN 1092-2.

**Counter-flanges** (on request)

Sizes	Flanges
from 32-160 to 50-250	Screwed flanges PN 16 EN 1092-1
from 65-125 to 150-400	Flanges for welding PN 10 EN 1092-1

## Shaft sealing

- Standardized mechanical seal in accordance with ISO 3069.
- Stuffing box seal (on request).

## Applications

For clean liquids, without abrasives, which are non-aggressive for the pump materials (contents of solids up to 0.2%).

For water supply.

For heating, air conditioning, cooling and circulation plants.

For civil and industrial applications and for agriculture.

For fire fighting applications.

For irrigation.

## Operating conditions

Liquid temperature from -10 °C to +90 °C.

Ambient temperature up to 40 °C.

Total suction lift up to 7 m.

Maximum permissible working pressure up to 10 bar (16 bar for N,N4 65/125, N,N4 65/160 and N,N4 80/160).

Maximum permissible rotation speed: see table on page 68.

## Pump-Motor unit

N,N4 pump connected to a standard electric motor in B3 construction form (EN 60072-1), by means of a baseplate, driven by a flexible coupling and with coupling protection.

Three-phase 400 V , 50 Hz

**Classification scheme IE3 for three-phase motors from 0,75 kW.**

IP 55 protection.

Motor suitable for operation with frequency converter.

## Special features on request

- Special mechanical seal.
- Chrome-nickel steel AISI 316 pump-shaft.
- Higher or lower liquid or ambient temperatures.
- Other motor protection.
- Motor for other voltage.
- Frequency 60 Hz (as per 60 Hz data sheet).



**Coverage chart n ≈ 2900 rpm**

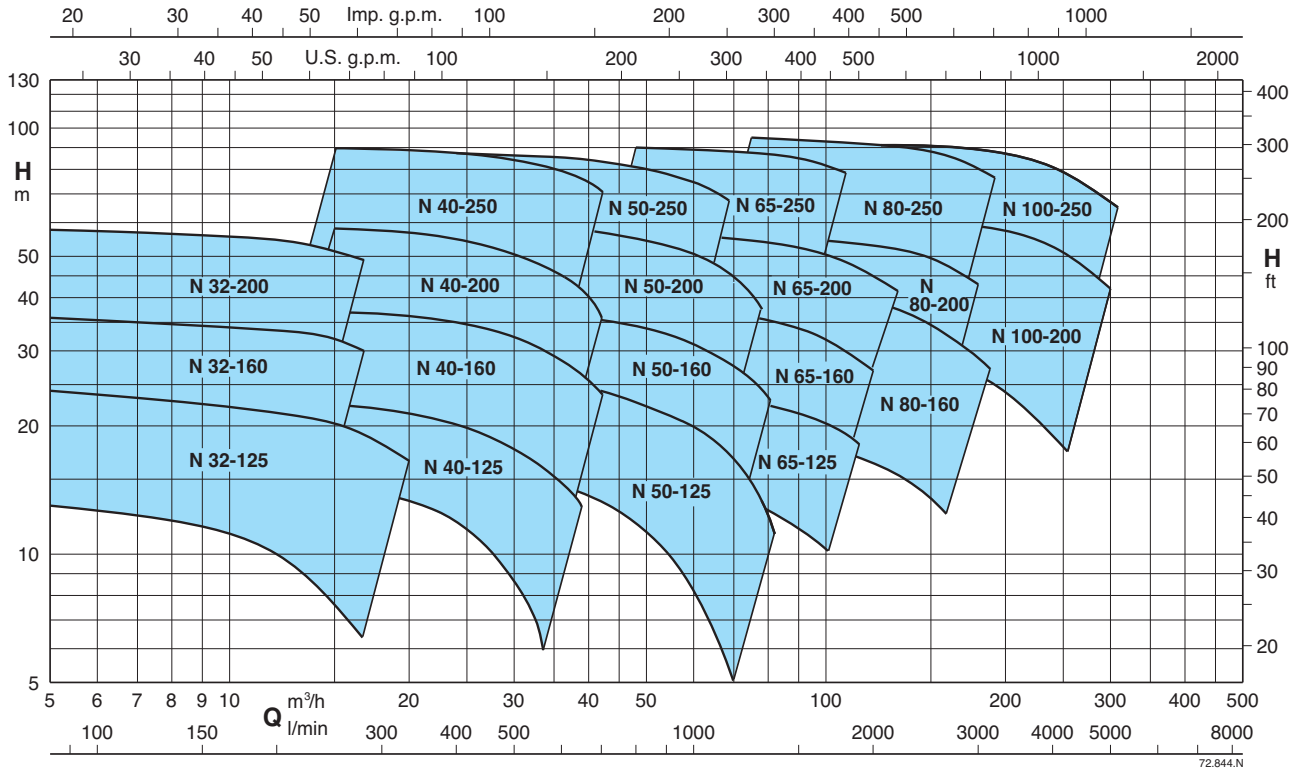

72.844.N

Tolerances according to UNI EN ISO 9906:2012

**Performance n ≈ 2900 rpm**

PUMP	PUMP	MOTOR	P <sub>2</sub> kW	Q m³/h	Flow Rate (Q)																			
					6,6	7,5	8,4	9,6	10,8	12	13,2	15	16,8	18,9	21	24	27	30	33	37,8	39	42	45	48
				Q	110	125	140	160	180	200	220	250	280	315	350	400	450	500	550	630	650	700	750	800
B-N 32-125F/A	N 32-125F/A	71 M2	0,55	12,5	12,5	12	11,5	11	10,5	9,5	8	6												
B-N 32-125D/A	N 32-125D/A	80 M2 80 M2	0,75 1,1	18	18	17,5	17	16,5	16	15,5	14	12,5	11	8,5										
B-N 32-125A/A	N 32-125A/A	80 M2 90 S2	1,1 1,5	23	23	22,5	22	21,5	21	20,5	19,5	18	16	14	10									
B-N 32-125S/A	N 32-125S/A	90 S2	1,5	23,5	23,5	23	22,5	22	21,5	21	20,5	19	18,5	16,5	13									
B-N 32-160B/A	N 32-160B/A	90 S2 100 L2	1,5 2,2	29,5	29,5	29	28,5	27,5	27	26	25*	22,5*	20*	17,5*	12,5*									
B-N 32-160A/A	N 32-160A/A	90 L2 100 L2	2,2 3	35,5	35,5	35	34,5	34	33,5	33	32*	30*	28*	25*	21*	15*								
B-N 32-200D/A	N 32-200D/A	90 L2 100 L2	2,2 3	37,5	37	36	35	34	33	32	30	27	22											
B-N 32-200C/A	N 32-200C/A	100 L2	3	44,5	44	43,5	43	42	41	40	38,5	36	32											
B-N 32-200A/A	N 32-200A/A	112 M2 132 S2	4 5,5	57	56,5	56	55,5	54,5	53,5	52,5	51	49	46											
B-N 40-125F/A	N 40-125F/A	80 M2	1,1								14	13,5	13	12										
B-N 40-125C/A	N 40-125C/A	90 S2	1,5								17,5	17	16,5	16	15	13,5	12	10,5	8	6				
B-N 40-125A/A	N 40-125A/A	90 L2	2,2								22	22	21,5	21	20	19	18	16,5	14	13	11,5			
B-N 40-160C/A	N 40-160C/A	90 L2	2,2								23	22,5	22	21,5	20	18,5	16,5	14,5	11	10				
B-N 40-160B/A	N 40-160B/A	100 L2	3								29	28,8	28	27,5	26,5	25	23,5	21,5	18	17	14			
B-N 40-160A/A	N 40-160A/A	112 M2 132 S2	4 5,5								37	36,5	36,5	36	35	33,5	32	30,5	27	26	23,5	20	17	
B-N 40-200D/A	N 40-200D/A	112 M2 132 S2	4 5,5								39	38	37	36,5	35,5	33,5	32	30,5	27	26	23,5	20	17	
B-N 40-200C/A	N 40-200C/A	112 M2 132 S2	4 5,5								41,5	40,5	39,5	38	36	33,5	32	30,5	27	26	23,5	20	17	
B-N 40-200B/A	N 40-200B/A	132 S2 132 S2	5,5 7,5								50	49,5	48,5	47,5	45,5	43,5	41,5	37,5	30,5					
B-N 40-200AR/A	N 40-200AR/A	132 S2 132 S2	5,5 7,5								55	54,5	54	53	51	49	47,5	45,5	41,5	37,5	30,5			
B-N 40-200A/A	N 40-200A/A	132 S2	7,5								57,5	57	56,5	55,5	54,5	52,5	50,5	48	42,5	40,5	35			
B-N 40-250C/A	N 40-250C/A	160 M2	11								61	61	60,5	59,5	58,5	56,5	53,5	49,5	41,5	40	33,5			
B-N 40-250B/A	N 40-250B/A	160 M2	11								69,5	69,5	69	68,5	67	65,5	63,5	60,5	53,5	51	45			
B-N 40-250A/A	N 40-250A/A	160 M2	15								90	90	89,5	89	88,5	87	85	83	77,5	76	70,5			

N Standard construction.     P<sub>2</sub> Rated motor power output.     P<sub>3</sub> Pump power input.     H Total head in m.     \* Maximum suction lift 1-2 m.  
B-N Bronze construction.



### Coverage chart $n \approx 1450$ rpm

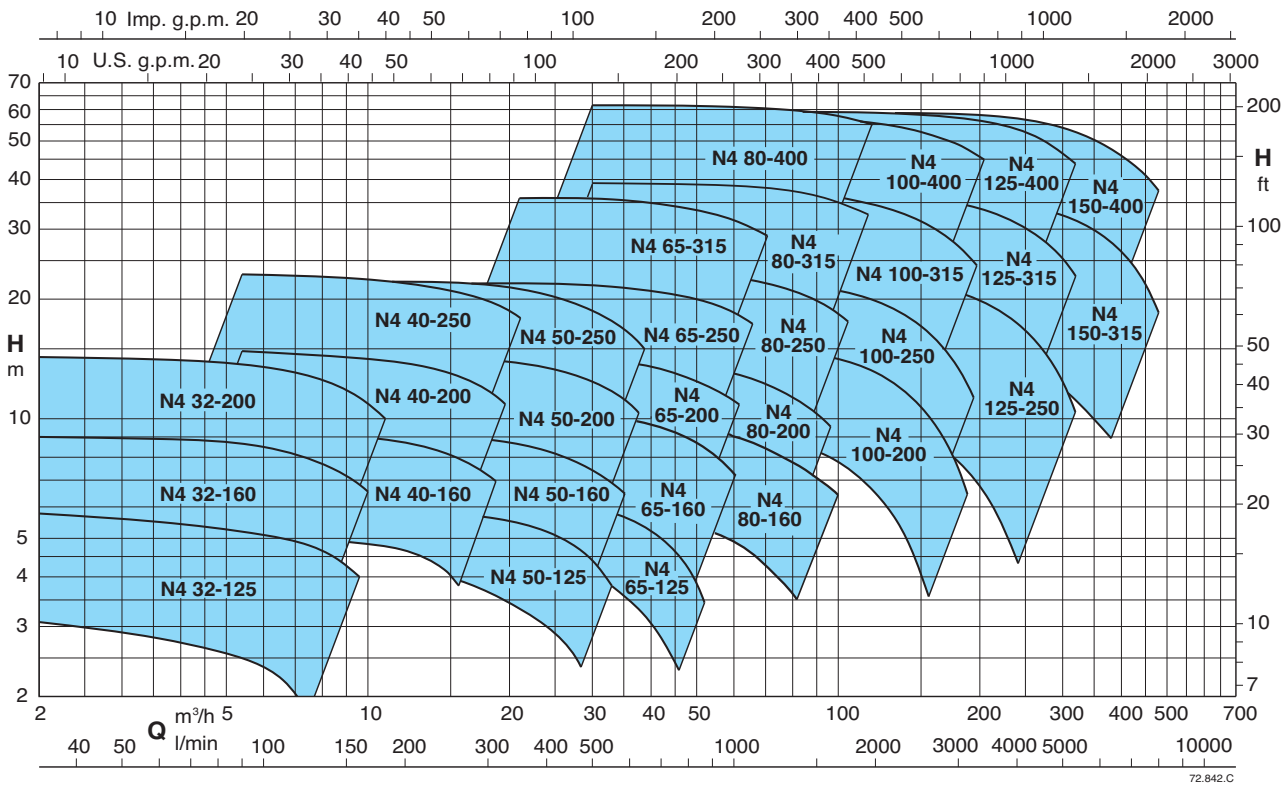

72.842.C

Tolerances according to UNI EN ISO 9906:2012

### Performance $n \approx 1450$ rpm

PUMP	PUMP	MOTOR	P <sub>2</sub> kW	Q																
				2,4	3	3,6	4,2	4,8	5,4	6	6,6	7,5	8,4	9,6	10,8	12	13,2			
				Q l/min																
				H m																
B-N4 32-125F/A	N4 32-125F/A	71 M4	0,25	3,6	3,6	3,5	3,5	3,4	3,2	3	2,8	2,4	1,9	1,1						
				0,07	0,075	0,08	0,09	0,095	0,1	0,1	0,105	0,11	0,115	0,115						
B-N4 32-125D/A	N4 32-125D/A	71 M4	0,25	4,7	4,7	4,7	4,7	4,6	4,6	4,5	4,3	3,8	3,3	2,6						
				0,095	0,075	0,11	0,115	0,125	0,13	0,135	0,145	0,15	0,155	0,165	0,17					
B-N4 32-125A/A	N4 32-125A/A	71 M4	0,25	5,7	5,8	5,8	5,7	5,7	5,7	5,6	5,5	5,4	5,2	4,8	4,3					
				0,12	0,1	0,135	0,145	0,15	0,16	0,165	0,175	0,185	0,195	0,205	0,215					
B-N4 32-160B/A	N4 32-160B/A	71 M4	0,37	7,6	7,5	7,4	7,3	7,2	7,1	6,9	6,7	6,3	5,9	5,2	4,2					
				0,13	0,125	0,15	0,16	0,17	0,18	0,19	0,2	0,21	0,215	0,23	0,235					
B-N4 32-160A/A	N4 32-160A/A	71 M4	0,37	9	8,95	8,9	8,8	8,7	8,6	8,5	8,3	7,9	7,5	6,8	6	5,1				
				0,17	0,18	0,19	0,2	0,21	0,22	0,23	0,24	0,26	0,275	0,29	0,305	0,315				
B-N4 32-200B/A	N4 32-200B/A	80 M4	0,55	12,5	12,4	12,3	12,2	12	11,8	11,6	11,2	10,6	10	8,9	7,6	6,2	4,7			
				0,28	0,3	0,315	0,33	0,345	0,36	0,375	0,39	0,41	0,43	0,455	0,48	0,5	0,515			
B-N4 32-200A/A	N4 32-200A/A	80 M4	0,75	14,3	14,2	14,1	14	13,9	13,7	13,5	13,3	12,9	12,3	11,3	10,2	8,9	7,5			
				0,35	0,375	0,4	0,42	0,44	0,46	0,48	0,5	0,525	0,55	0,585	0,61	0,635	0,655			

PUMP	PUMP	MOTOR	P <sub>2</sub> kW	Q																
				5,4	6	6,6	7,5	8,4	9,6	10,8	12	13,2	15	16,8	18,9	21	24	27	30	
				Q l/min																
				H m																
B-N4 40-160C/A	N4 40-160C/A	71 M4	0,37	6,1	6	5,9	5,9	5,8	5,6	5,4	5,2	5	4,5	3,9	3,1	2,3				
				0,17	0,18	0,19	0,2	0,21	0,23	0,24	0,25	0,26	0,27	0,28	0,29	0,3	0,31	0,3		
B-N4 40-160B/A	N4 40-160B/A	80 M4	0,55	7,6	7,6	7,6	7,6	7,6	7,3	7,1	6,9	6,6	6,3	5,7	5	4	2,7			
				0,22	0,23	0,24	0,26	0,27	0,29	0,31	0,32	0,34	0,36	0,38	0,39	0,4	0,41			
B-N4 40-160A/A	N4 40-160A/A	80 M4	0,75	9,6	9,6	9,6	9,6	9,4	9,3	9,1	9	8,8	8,4	7,9	7,2	6,4	5,1	3,5		
				0,28	0,3	0,31	0,33	0,35	0,37	0,4	0,42	0,44	0,47	0,49	0,51	0,53	0,55	0,56		
B-N4 40-200B/A	N4 40-200B/A	90 S4	1,1	13	12,9	12,8	12,7	12,6	12,4	12,2	12	11,5	10,8	10	8,6	7				
				0,51	0,53	0,53	0,54	0,57	0,60	0,63	0,66	0,68	0,71	0,75	0,78	0,81	0,83			
B-N4 40-200A/A	N4 40-200A/A	90 S4	1,1	14,8	14,7	14,6	14,5	14,4	14,2	14,2	14	13,8	13,6	13	12,2	11,3	10			
				0,59	0,6	0,6	0,61	0,64	0,67	0,71	0,74	0,77	0,8	0,85	0,9	0,94	0,97			
B-N4 40-250C/A	N4 40-250C/A	90 L4	1,5	17,4	17,3	17,2	17,2	17	16,8	16,6	16,3	16	15,1	13,8	12,1	10,4	7,2	2,8		
				0,689	0,715	0,74	0,779	0,817	0,865	0,912	0,967	1,018	1,092	1,134	1,178	1,248	1,301	1,348		
B-N4 40-250B/A	N4 40-250B/A	100 LA4	2,2	21,4	21,5	21,4	21,3	21,2	21	20,9	20,8	20,5	20	19,5	18,3	16,4	13,3	10		
				0,908	0,942	0,99	1,025	1,075	1,140	1,203	1,266	1,327	1,405	1,482	1,567	1,645	1,752	1,815	1,887	
B-N4 40-250A/A	N4 40-250A/A	100 LB4	3	22,9	22,8	22,9	22,9	22,8	22,5	22,5	22,2	22	21,8	21,4	20,4	18,9	16	12,6		
				1,068	1,104	1,15	1,193	1,246	1,316	1,385	1,454	1,521	1,638	1,733	1,817	1,933	2,068	2,168	2,267	

**N4** Standard construction.  
**B-N4** Bronze construction.

P<sub>2</sub> Rated motor power output.  
P<sub>3</sub> Pump power input.

H Total head in m.

\* Maximum suction lift 1-2 m.





### Performance n ≈ 1450 rpm

PUMP B-N4	PUMP N4	MOTOR	P <sub>2</sub> kW	Q m <sup>3</sup> /h	48	54	60	66	75	84	96	108	120	132	150	168	180	192	210				
				Q l/min	800	900	1000	1100	1250	1400	1600	1800	2000	2200	2500	2800	3000	3200	3500				
B-N4 100-200C/A	N4 100-200C/A	100 L4	3	H m	9,4	9,3	9,2	9,1	8,9	8,5	8	7,3	6,5	5,6									
					2,65	2,2	2,3	2,4	2,5	2,6	2,7	2,8	2,85	2,9	2,85								
					12	11,9	11,8	11,7	11,5	11,2	10,7	10	9,3	8,4	6,7	4,5							
					3,65	3,85	4	4,15	4,4	4,6	4,85	5,1	5,3	5,45	5,55	5,65	5,75	6*					
					19,5	19,5	19,4	19,3	19	18,7	18,2	17,5	16,6	15,6	13,8	11,7	10	8,4	5,5				
					4,8	5	5,2	5,4	5,75	6,05	6,4	6,7	7	7,3	7,5	7,5	7,5	7,5	7,5	7,5	7,5	7,5	7,5
					22,3	22,3	22,2	22,1	21,9	21,7	21,2	20,5	19,8	18,8	17,1	15	13,4	11,7	9				
					5,5	5,8	6,05	6,25	6,6	6,95	7,35	7,75	8,1	8,35	8,7	9	9,05	9,05	9,05	9,05	9,05	9,05	9,05
					26,9	26,9	26,8	26,6	26,2	25,7	24,9	23,8	22,7	21,3	18,9	15,9	13,7	11,3*					
					6,6	6,7	7,35	7,65	8,1	8,5	9	9,5	9,85	10,2	10,7	10,9	10,9	10,9	10,9	10,9	10,9	10,9	10,9
B-N4 100-315C/A	N4 100-315C/A	160 M4	11	H m	31,5	31,5	31,4	31,3	31,2	30,8	30,2	29,3	28,2	26,9	24,6	19,8							
					7,8	8,25	8,65	9	9,6	10,2	10,9	11,5	12,1	12,6	13,3	13,9	14,1	14,4	14,4	14,4	14,4		
					36,9	36,9	36,8	36,7	36,6	36,4	36	35,3	34,5	33,4	31,4	29	27,2	25,3*					
					9,7	10,2	10,7	11,2	11,9	12,5	13,3	14,1	14,9	15,6	16,6	17,4	17,9	18,3	18,3	18,3	18,3	18,3	
					41,3	41,2	41,1	41	40,7	40,4	39,8	39	38	36,5	34	31	28,7	26					
					11,1	11,8	12,5	13,2	14,7	14,8	16	17	18	18,9	20	21	21,7	22					
					50,2	50,1	50	49,9	49,7	49,4	48,8	48	47,1	46	44	41,3	39,5	37					
					15,2	16	16,8	17,4	18,4	19,3	20,6	21,8	23	24,2	25,7	27	27,8	28,5	28,5	28,5	28,5	28,5	28,5
					58,2	58,1	58	57,9	57,8	57,6	57,2	56,3	55,7	54,5	52,7	50,5	49	47					
					17,8	18,75	19,7	20,5	21,7	22,9	24,4	25,9	27,4	28,8	30,9	32,7	33,85	35	36,5				

PUMP B-N4	PUMP N4	MOTOR	P <sub>2</sub> kW	Q m <sup>3</sup> /h	84	96	108	120	132	150	168	180	192	210	240	270	300	330			
				Q l/min	1400	1600	1800	2000	2200	2500	2800	3000	3200	3500	4000	4500	5000	5500			
B-N4 125-250E/A	N4 125-250E/A	132 S4	5,5	H m	11	10,8	10,5	10,1	9,7	9,1	8,3	7,8	7,2	6,2	4,4						
					4,2	4,5	4,75	4,95	5,05	5,2	5,35	5,45	5,5	5,55							
					14	13,9	13,7	13,4	13	12,4	11,6	11	10,4	9,4	7,4	5,1					
					5,4	5,7	5,95	6,2	6,45	6,75	7	7,1	7,2	7,35	7,4	7,1					
					16,7	16,6	16,4	16,2	15,9	15,4	14,6	14,1	13,5	12,5	10,4	8,2	5,8				
					6,3	6,7	7,1	7,4	7,65	8,05	8,4	8,6	8,75	9	9,2	9,2	9,05				
					19,3	19,2	19,1	18,9	18,7	18,2	17,5	17	16,3	15,3	13,3	10,9	8,2				
					7,8	8,25	8,7	9,1	9,45	10	10,35	10,6	10,85	11,1	11,4	11,45	11,3				
					22,7	22,7	22,6	22,4	22,2	21,8	21,2	20,8	20,1	19,33	17,4	15	12,4	9,3			
					9,2	9,75	10,3	10,85	11,3	12	12,6	12,95	13,25	13,75	14,3	14,5	14,55	14,4			
B-N4 125-315C/A	N4 125-315C/A	180 M4	18,5	H m	27,9	27,8	27,7	27,6	27,2	26,5	25,6	24,9	24	22,8	20,2	17	13,5	9,5*			
					11,5	12,15	12,8	13,4	14	14,7	15,4	15,8	16,2	16,7	17,3	17,7	18	18	18		
					31,8	31,7	31,6	31,5	31,1	30,6	29,7	29,1	28,5	27,3	24,9	22	18,5	14,3*			
					12,75	13,6	14,45	15,3	15,9	16,8	17,7	18,4	19	19,7	20,6	21	22	22	22	22	
					36,8	36,8	36,7	36,6	36,4	35,9	35,2	34,7	34,2	33,2	31	28,4	25,3	21,6*			
					15,5	16,5	17,5	18,3	19,1	20,4	21,6	22,4	23,1	24,15	25,6	28,4	27,6	28,45			
					45,4	45,3	45,2	45,1	44,9	44,4	43,7	43	42	40	37	33	28,5*	23,5*			
					19,4	20,7	22	23,3	24,6	26,5	28,2	29,3	30,2	31,4	33,4	35	35,9	36,75			
					51,4	51,3	51,2	51,1	50,9	50,4	49,7	49	48,2	46,8	44	40,5	36*	31,5*			
					22,9	24,3	25,7	27,1	28,4	30,35	32,2	33,3	34,4	36	38,5	41	43	44,5			
B-N4 125-400C/A	N4 125-400C/A	225 S4	37	H m	59,2	59,1	59	58,9	58,7	58,2	57,7	57,2	56,7	55,7	53,5	50,5	46,5*	42,5*			
					27,8	29,4	30,9	32,4	33,9	36,2	38,4	39,8	41,2	43,2	46,2	49,2	52,1	54,4			

PUMP B-N4	PUMP N4	MOTOR	P <sub>2</sub> kW	Q m <sup>3</sup> /h	132	150	168	180	192	210	240	270	300	330	360	390	420	450	480			
				Q l/min	2200	2500	2800	3000	3200	3500	4000	4500	5000	5500	6000	6500	7000	7500	8000			
B-N4 150-315D/A	N4 150-315D/A	180 M4	18,5	H m	22,8	22,6	22,3	22	21,7	21,1	20	18,6	17	15,1	13	10,6	8*					
					13,8	14,5	15	15,4	15,75	16,2	16,9	17,6	18	18,35	18,45	18,4	18,15					
					25,6	25,4	25,1	24,9	24,7	24,2	23,3	22	20,4	18,5	16,5	14,1	11,6*	8,9*				
					15,6	16,44	17,2	17,65	18,1	18,8	19,7	20,6	21,3	21,75	22	22	22	22	22	22	22	22
					30,6	30,6	30,5	30,3	30,1	29,7	29	27,9	26,5	24,9	23	20,8	18,3*	15,4*				
					19	20	21	21,6	22,15	23	24,35	25,7	26,6	27,5	28,1	28,7	28,9	29				
					35,6	35,6	35,5	35,4	35,3	35,2	34,6	33,7	32,5	31	29,2	27,1	24,7*	21,8*	18,5*			
					23,1	24,4	25,7	26,5	27,2	28,3	30	31,6	33,1	34,3	35,4	36,3	37	37,5	37,5	37,5	37,5	37,5
					45	44,9	44,7	44,5	44	43,5	42,5	40,5	38,5	36	33,5	30,5	27*	23,5*	19,5*			
					27,9	29,65	31,4	32,6	33,8	35,3	37,7	39,7	41,3	42,7	43,8	44,1	44,1	44,1	44,1	44,1	44,1	44,1
B-N4 150-400C/A	N4 150-400C/A	225 M4	45	H m	50,8	50,7	50,5	50,3	50	49,5	48,5	47	45	43	40,5	38	35*	32*	28,5*			
					31,4	33,6	35,8	36,9	38,2	40	42,8	45,5	47,7	49,8	51,5	53	54,1	54,6	54,8			
					58,8	58,7	58,6	58,5	58,3	57,9	57	55,5	54	52	49,5	47	44*	41*	37,5*			
					38,2	40,7	42,8	44,35	45,7	48	51,5	54,4	57,1	59,7	62	64,2	66	67,5	68,4			

**N4** Standard construction.      P<sub>2</sub> Rated motor power output.      H Total head in m.      \* Maximum suction lift 1-2 m.  
**B-N4** Bronze construction.      P<sub>3</sub> Pump power input.



Characteristic curves  $n \approx 2900$  rpm

4

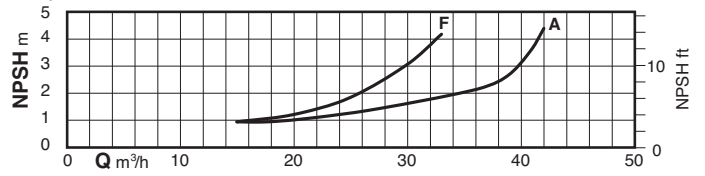
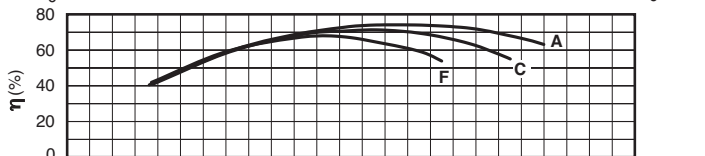
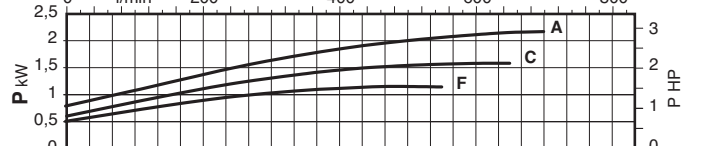
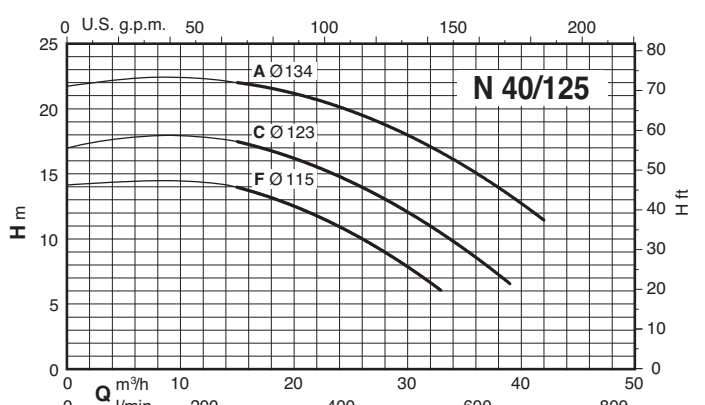
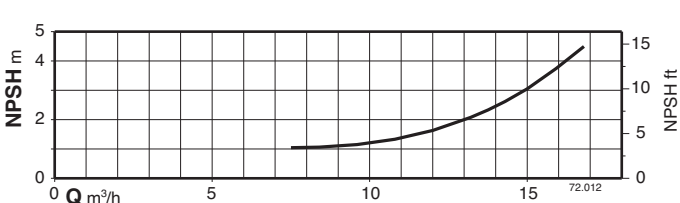
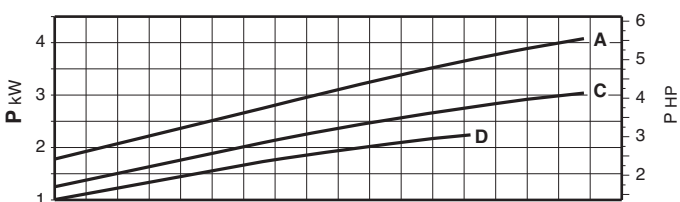
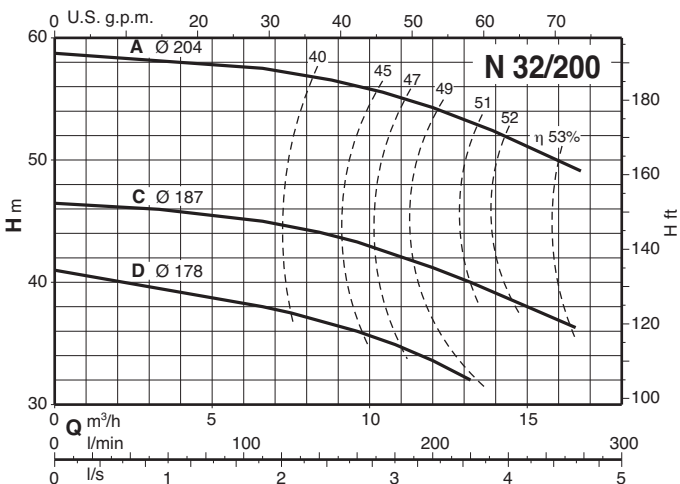
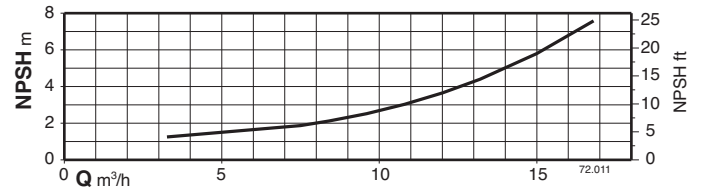
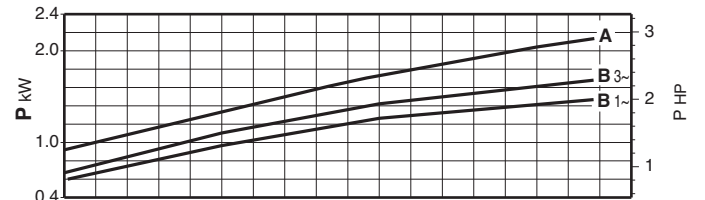
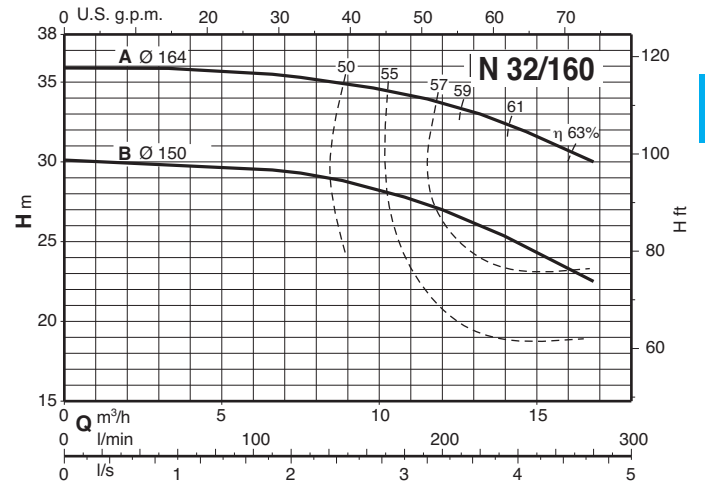
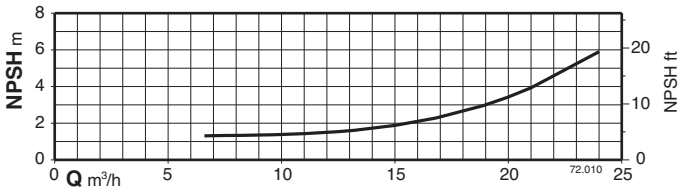
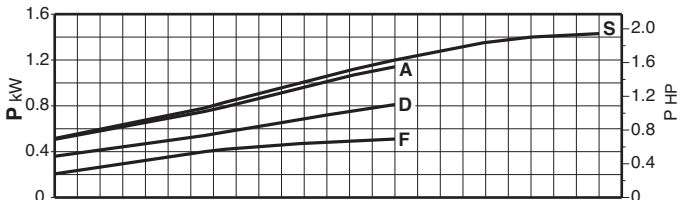
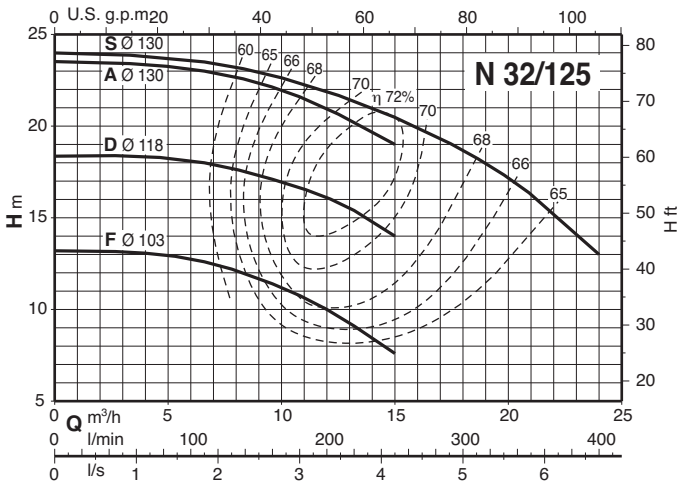



Characteristic curves  $n \approx 2900$  rpm

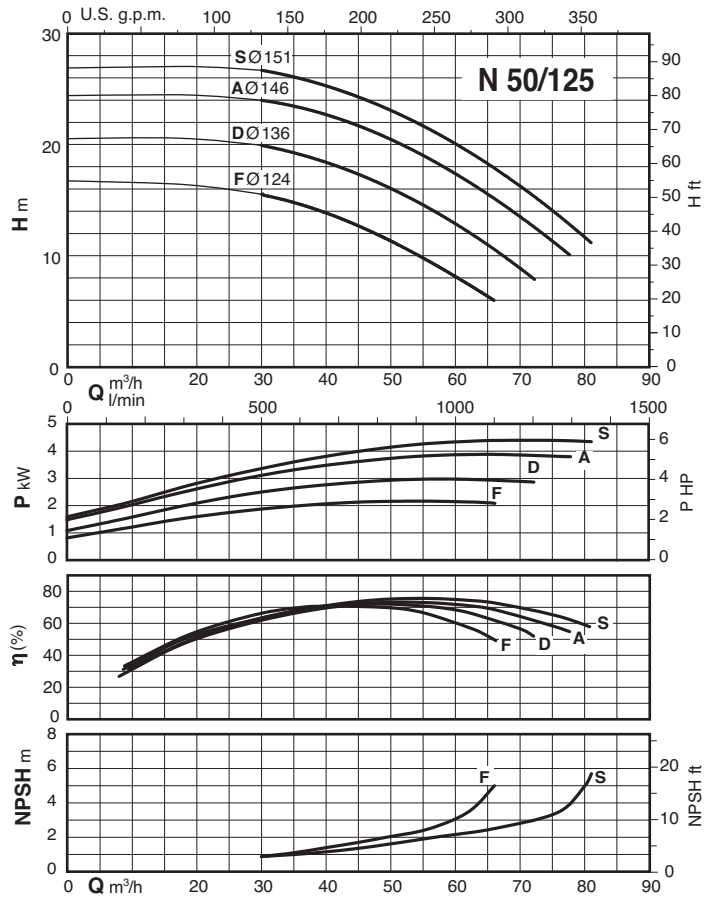
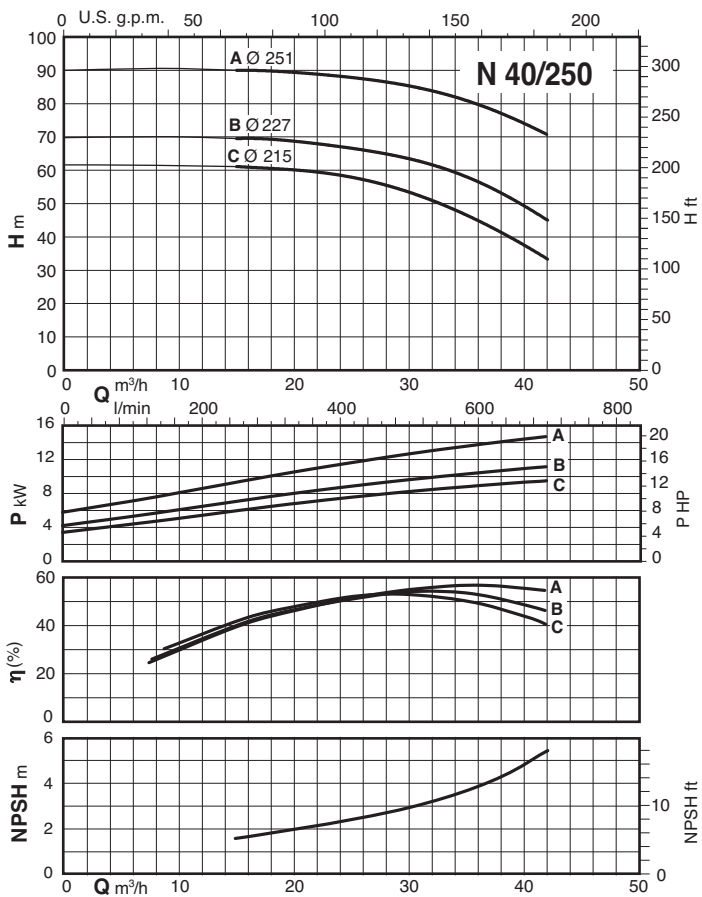
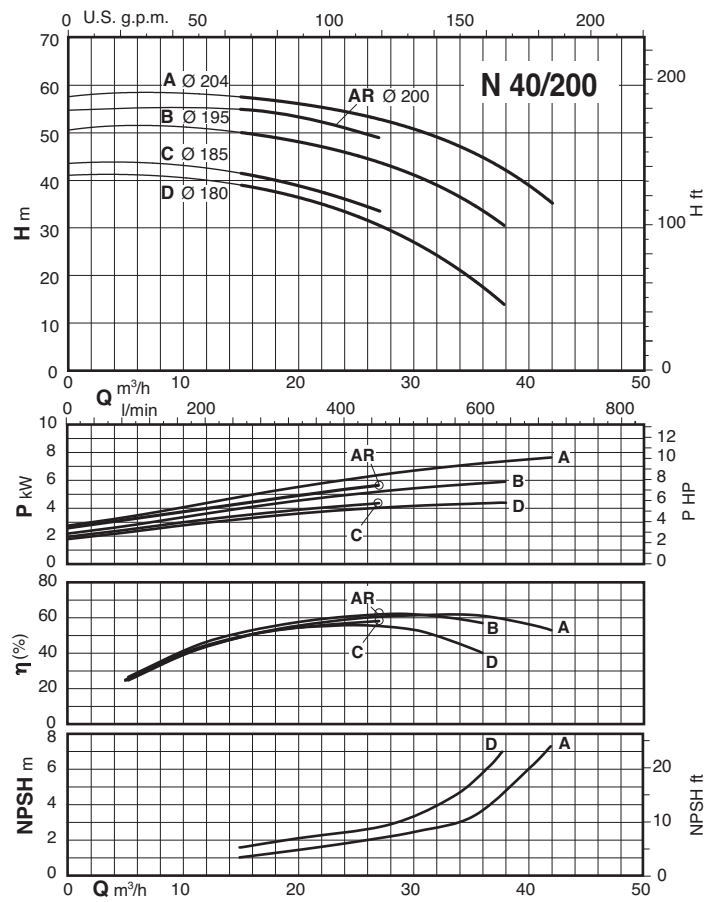
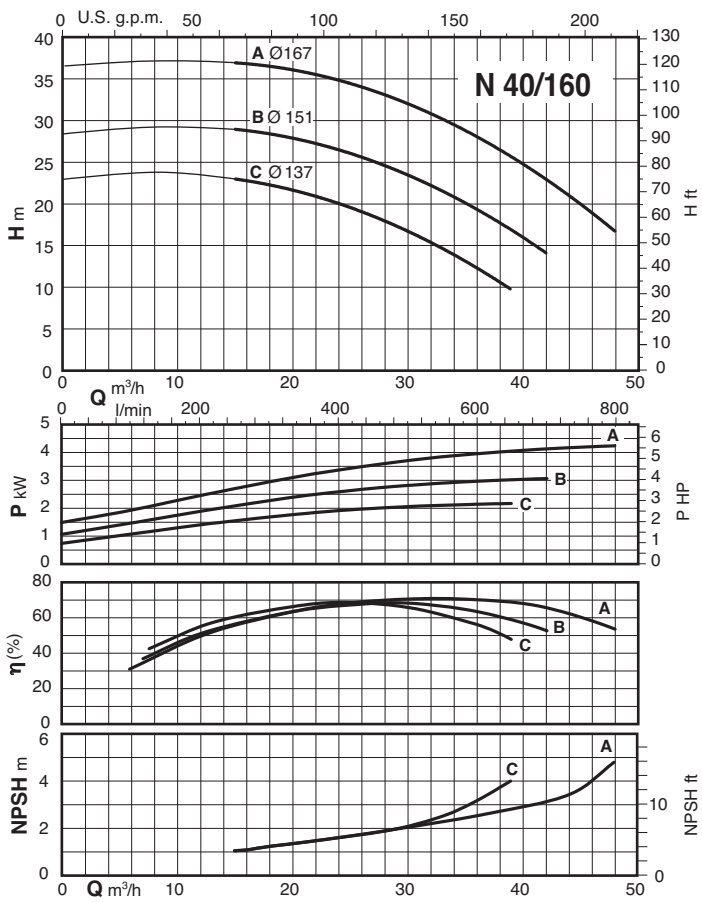





Characteristic curves  $n \approx 2900$  rpm

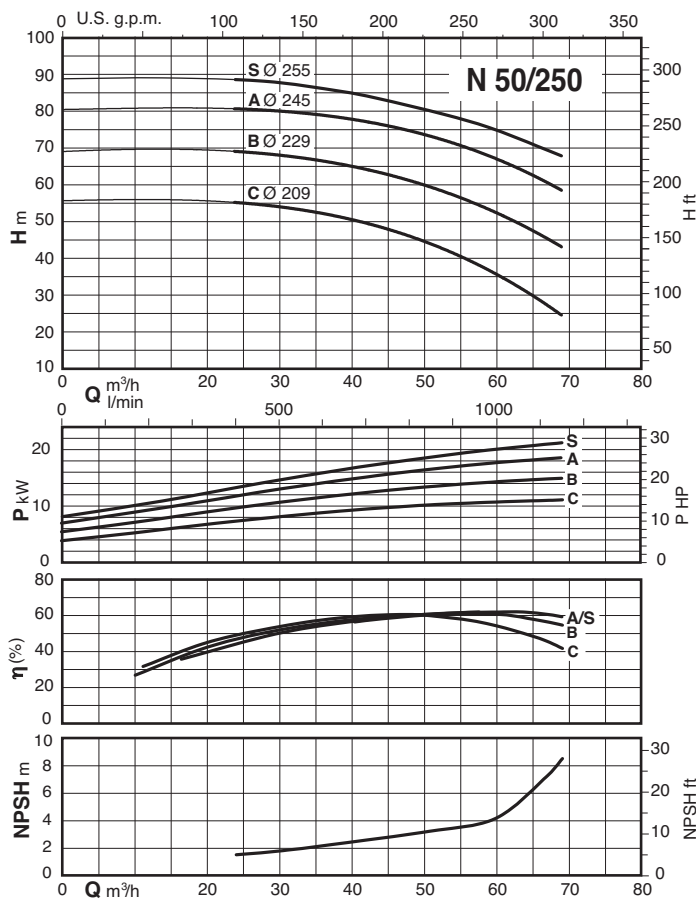
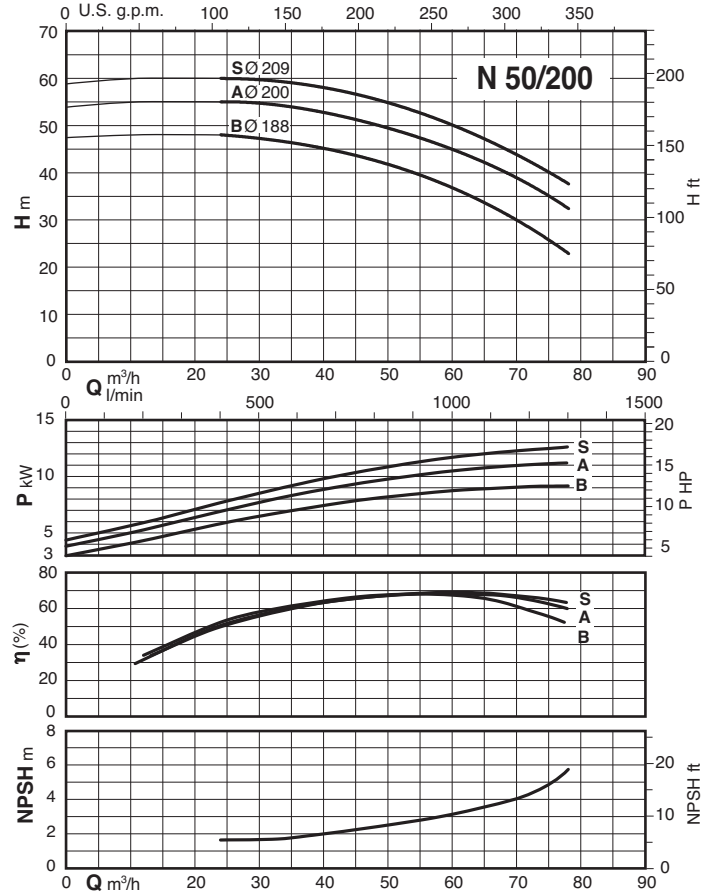
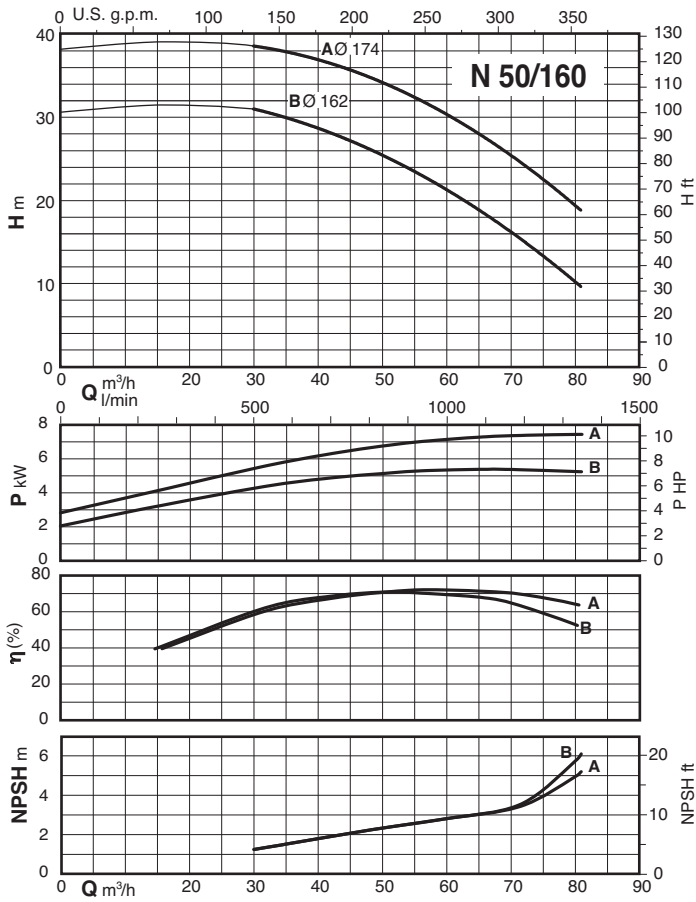

4



Characteristic curves  $n \approx 2900$  rpm

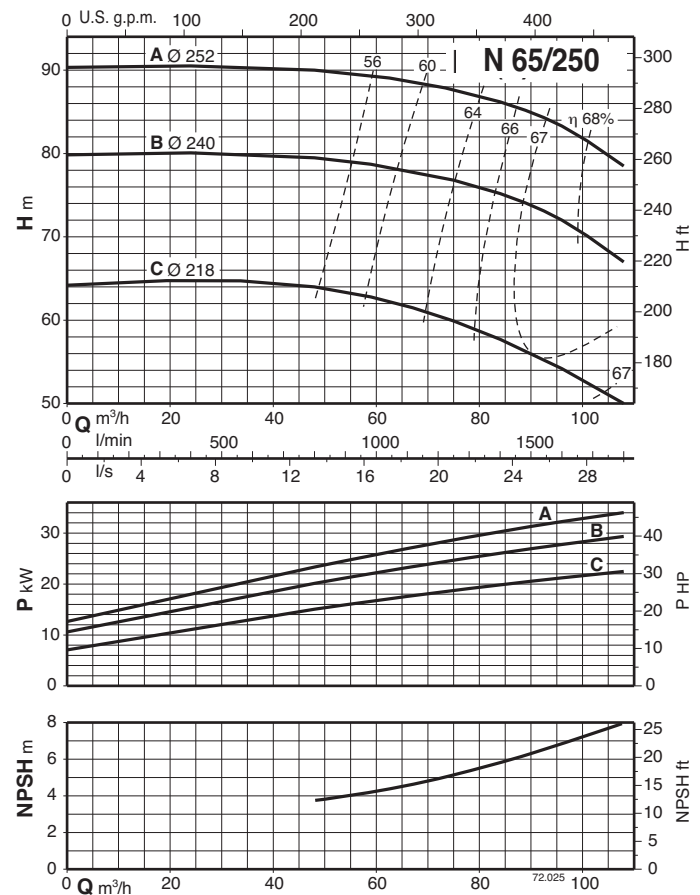
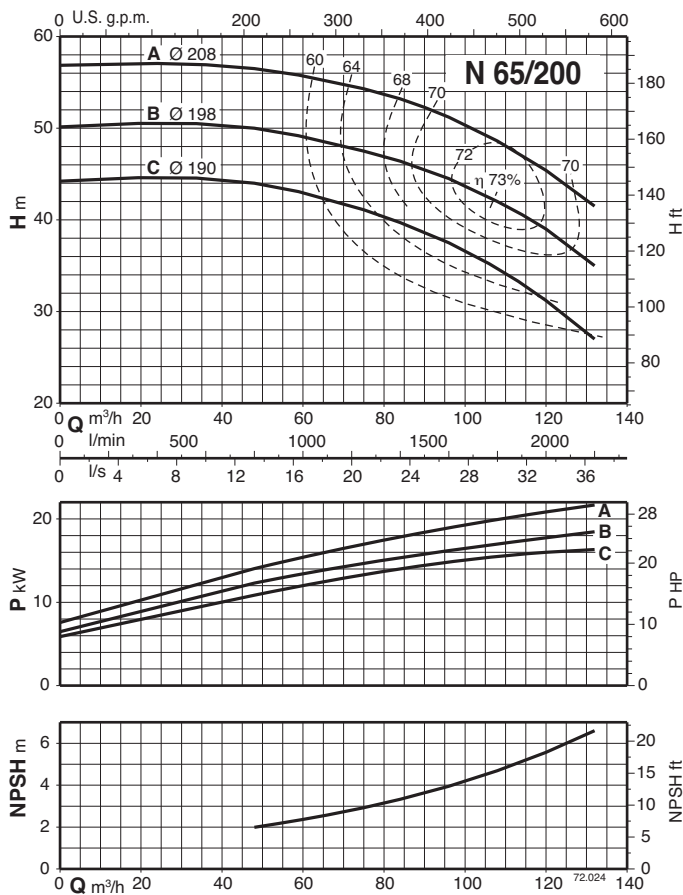
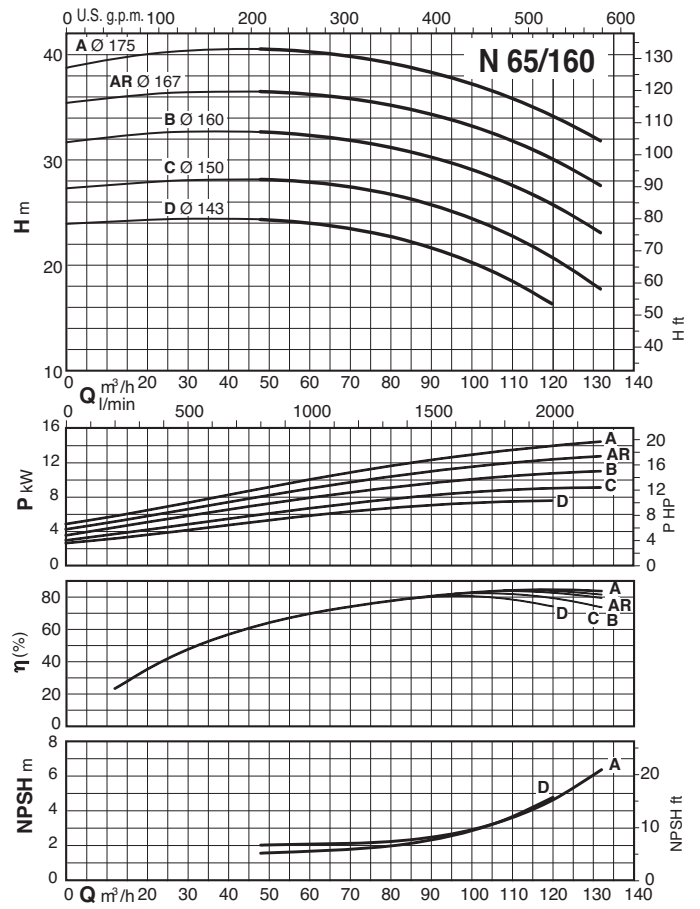
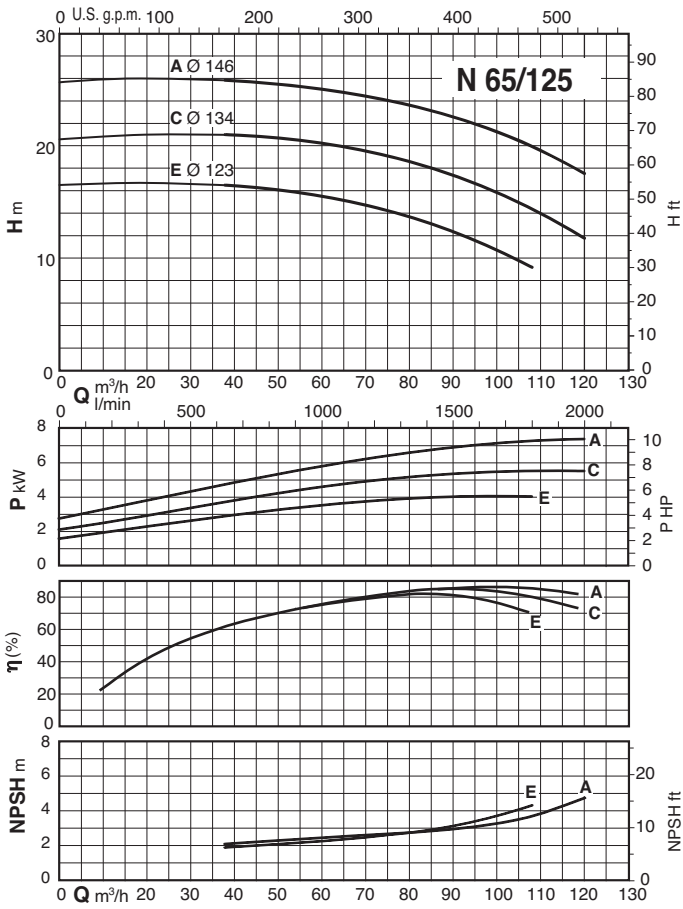



Characteristic curves  $n \approx 2900$  rpm

4

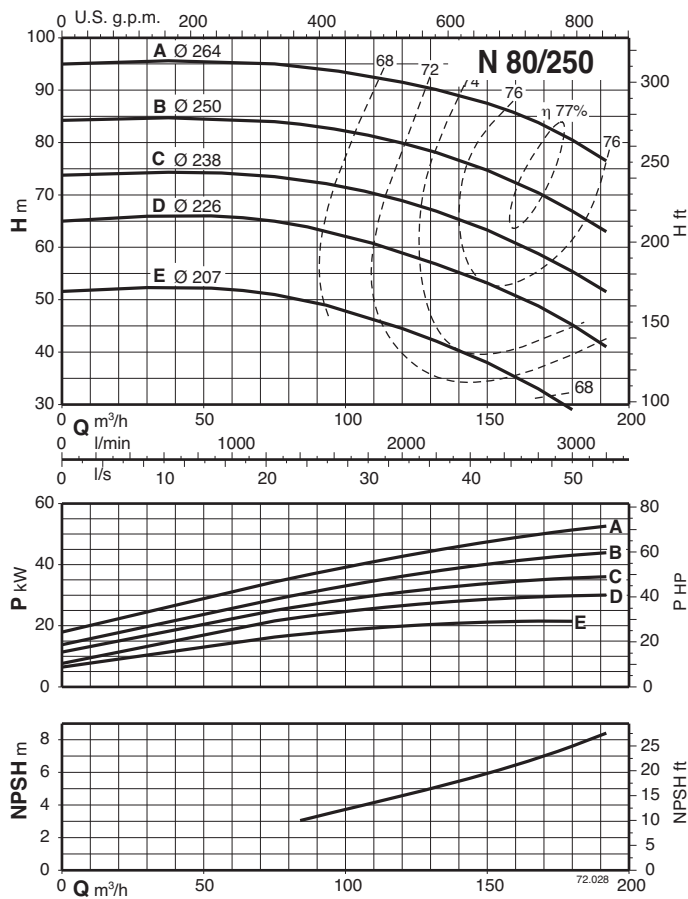
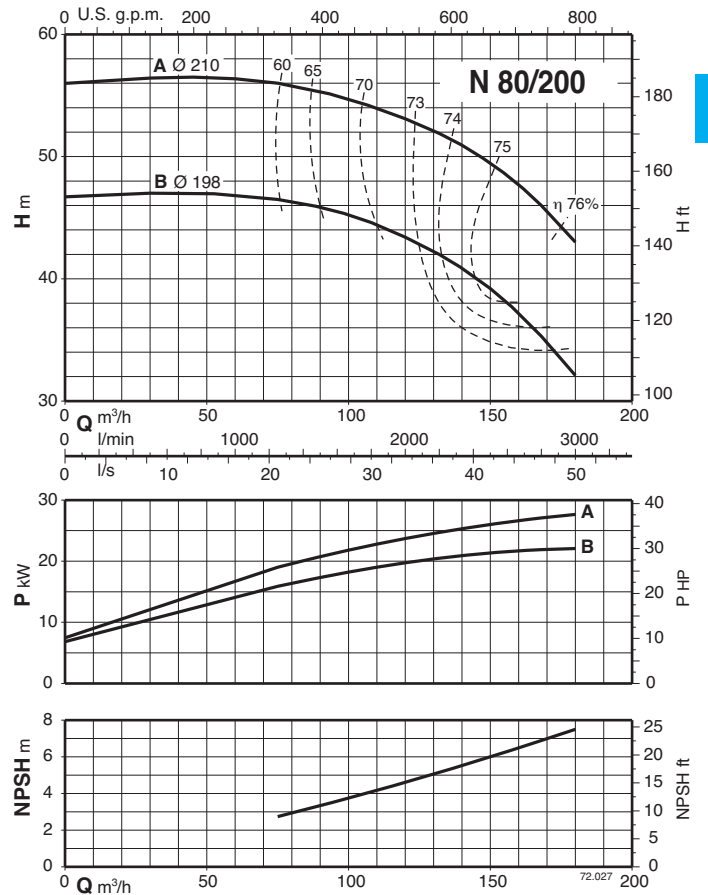
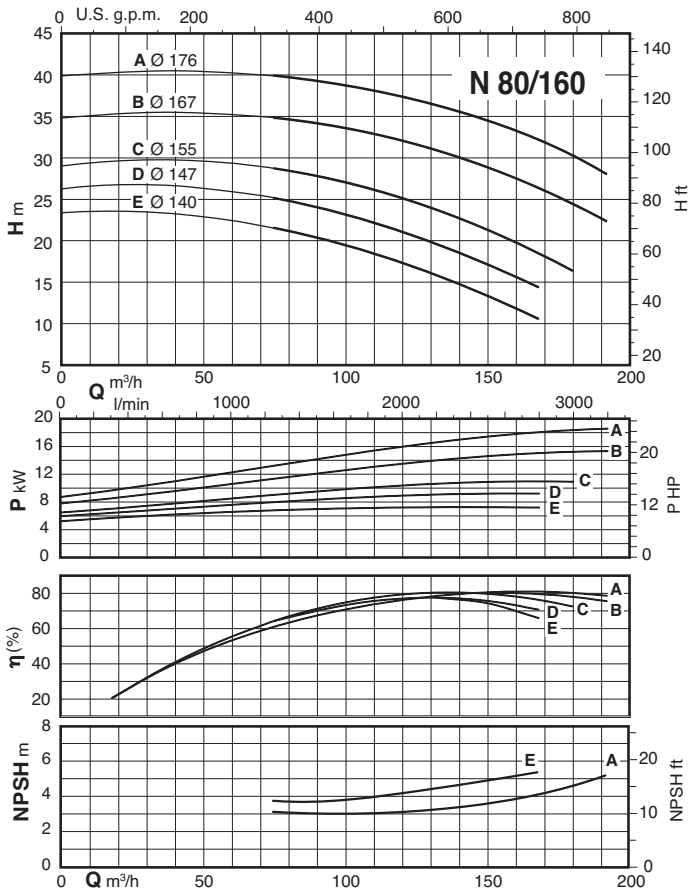



Characteristic curves  $n \approx 2900$  rpm

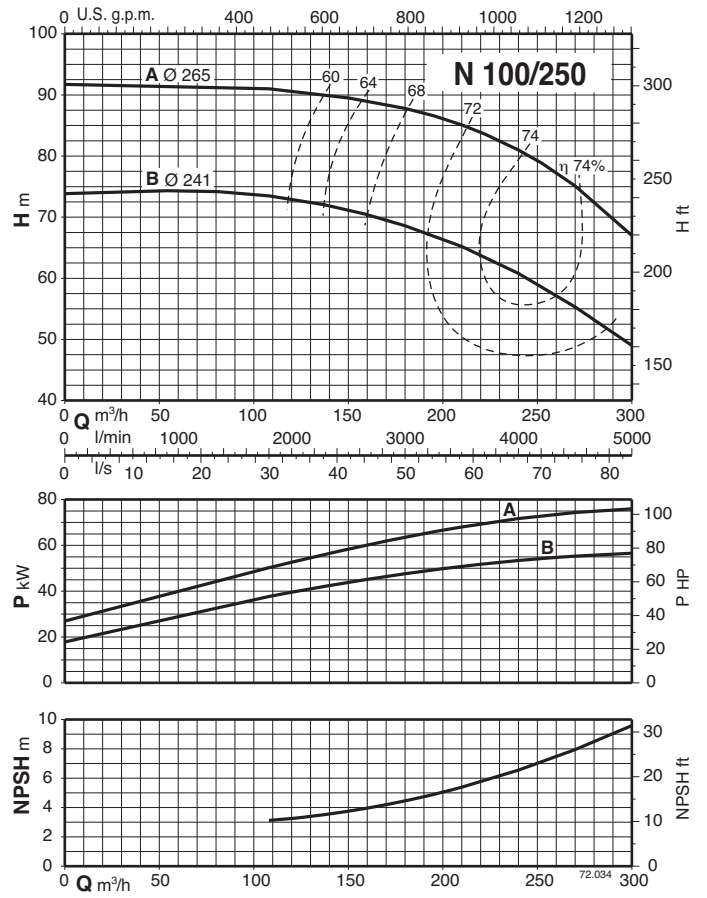
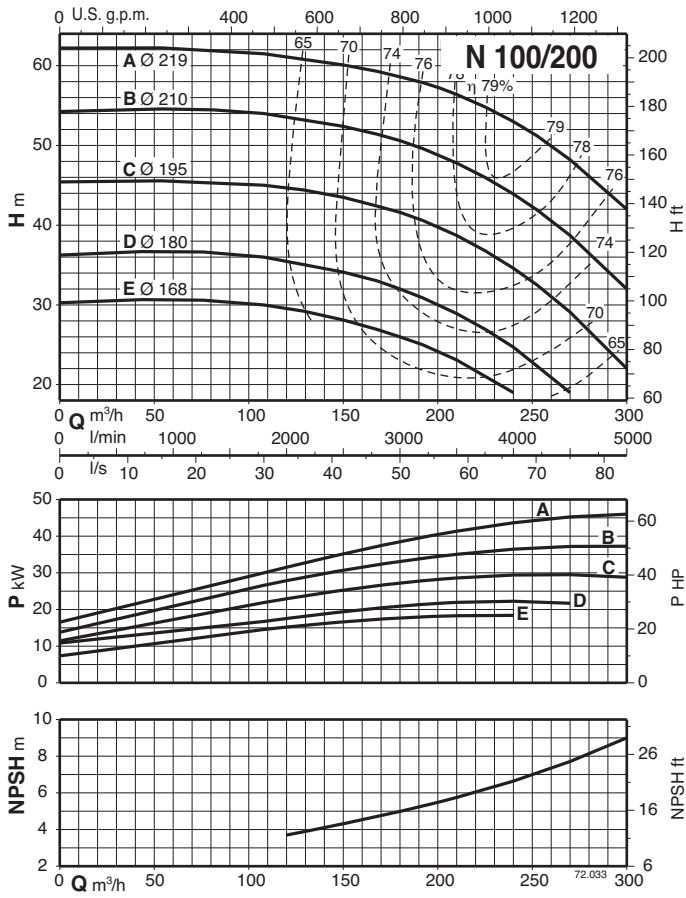

### Characteristic curves $n \approx 1450$ rpm

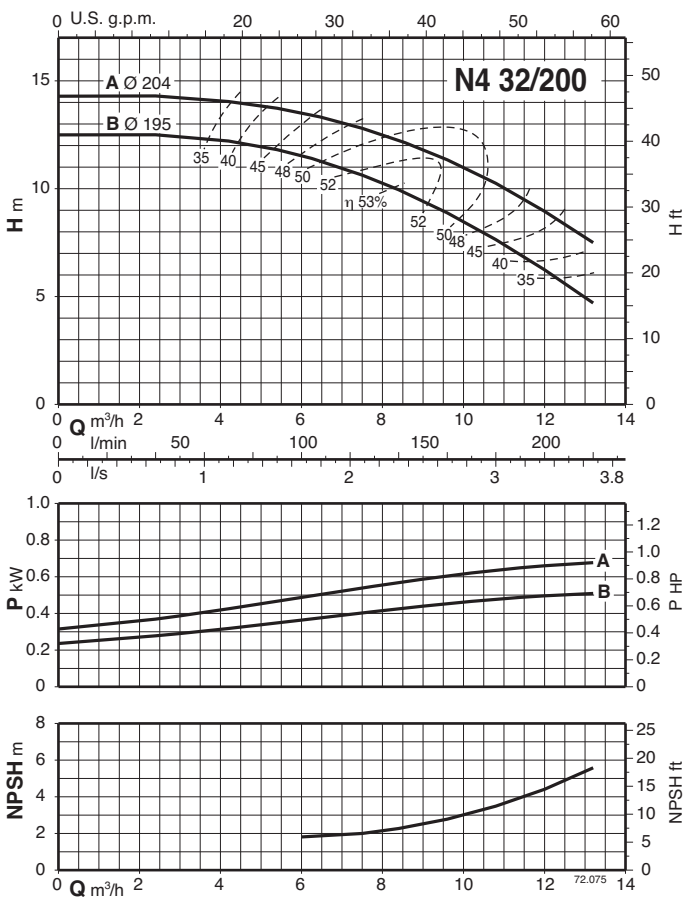
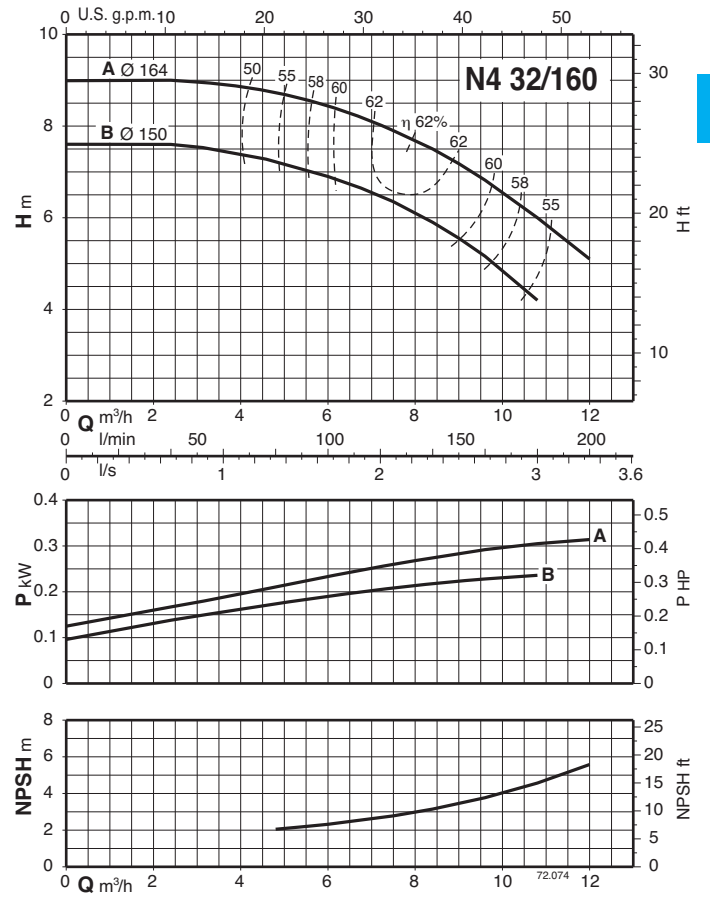
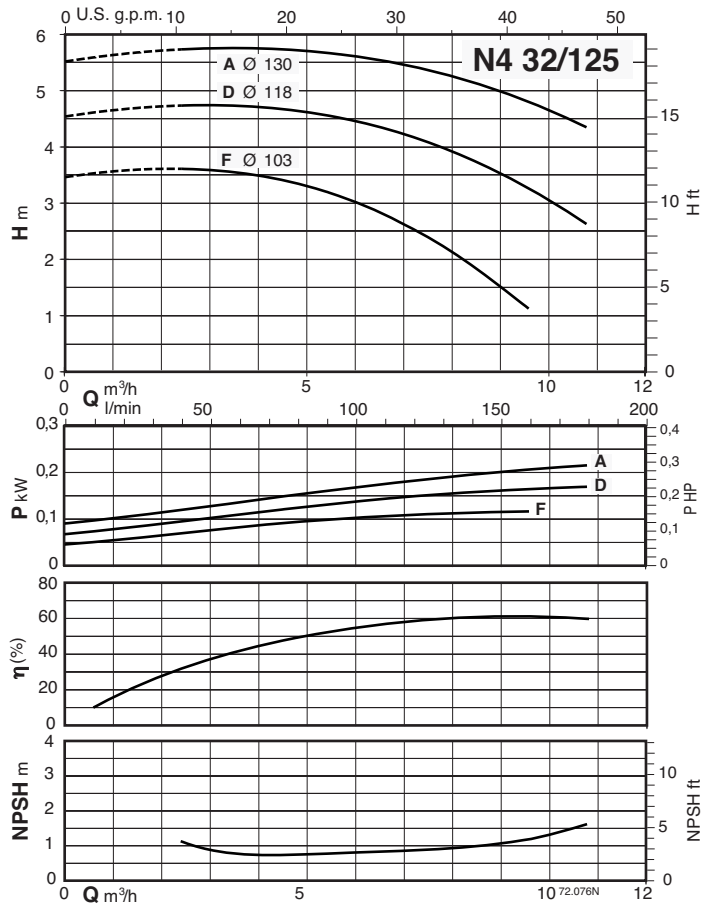



### Characteristic curves $n \approx 1450$ rpm

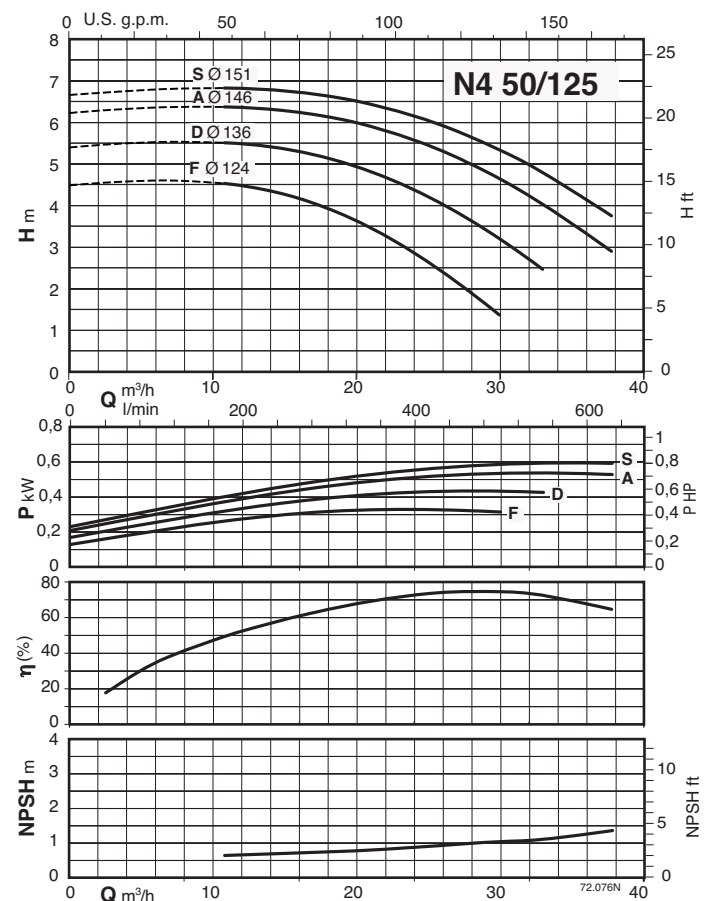
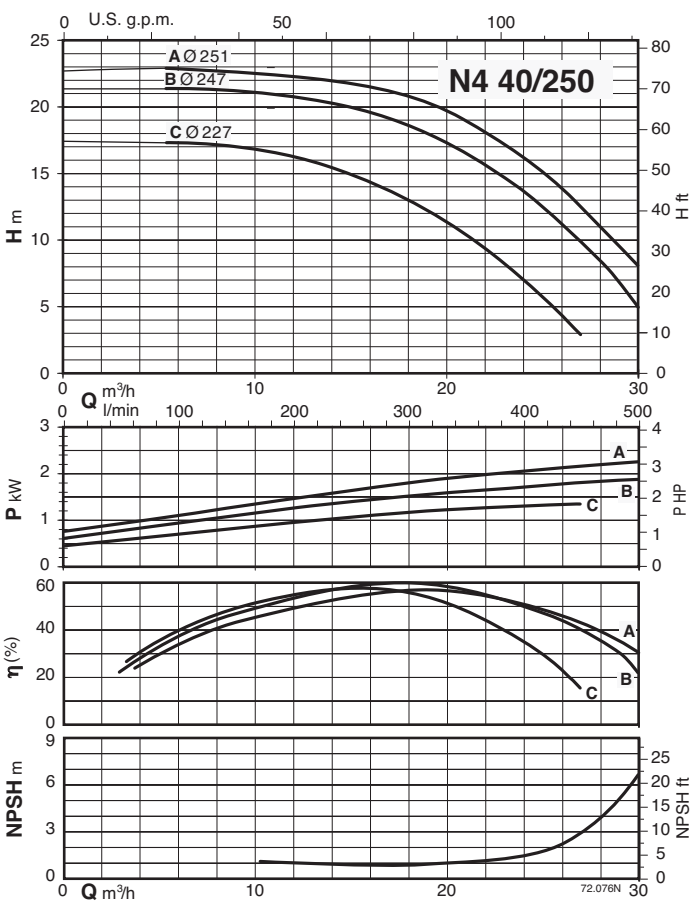
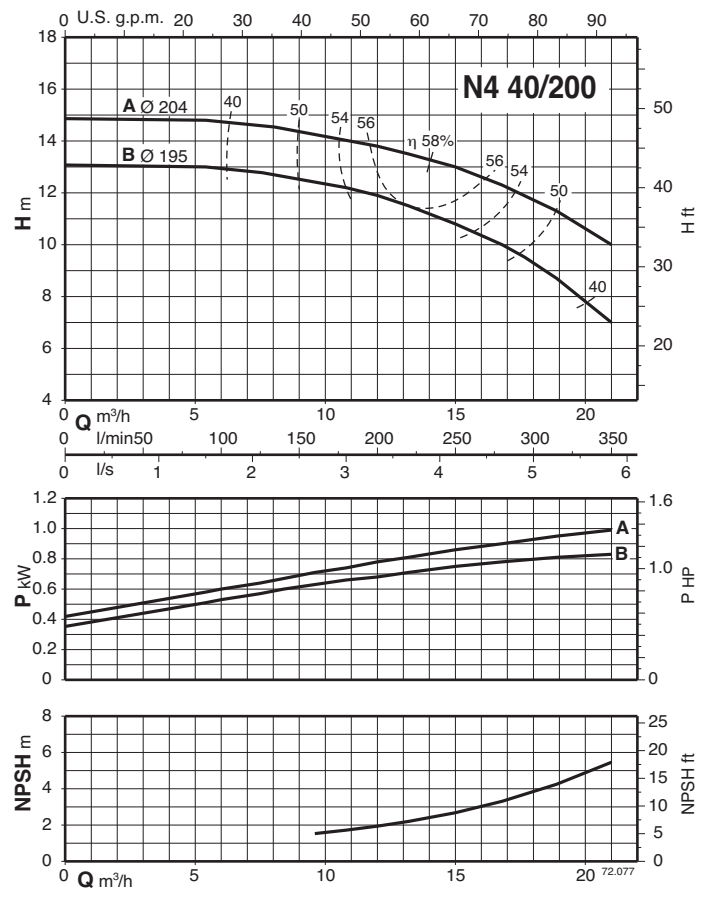
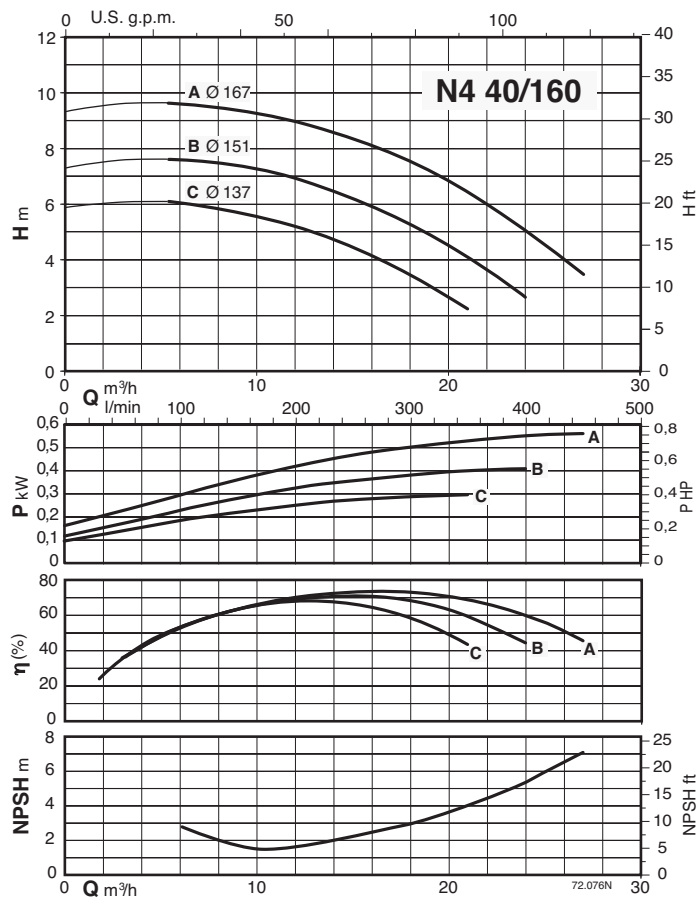

### Characteristic curves $n \approx 1450$ rpm

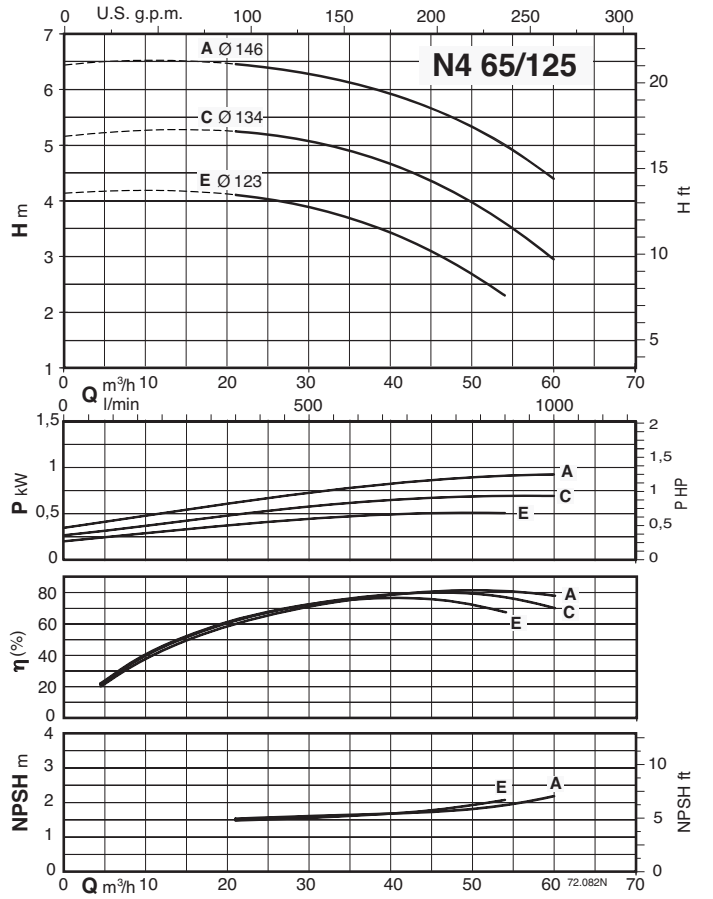
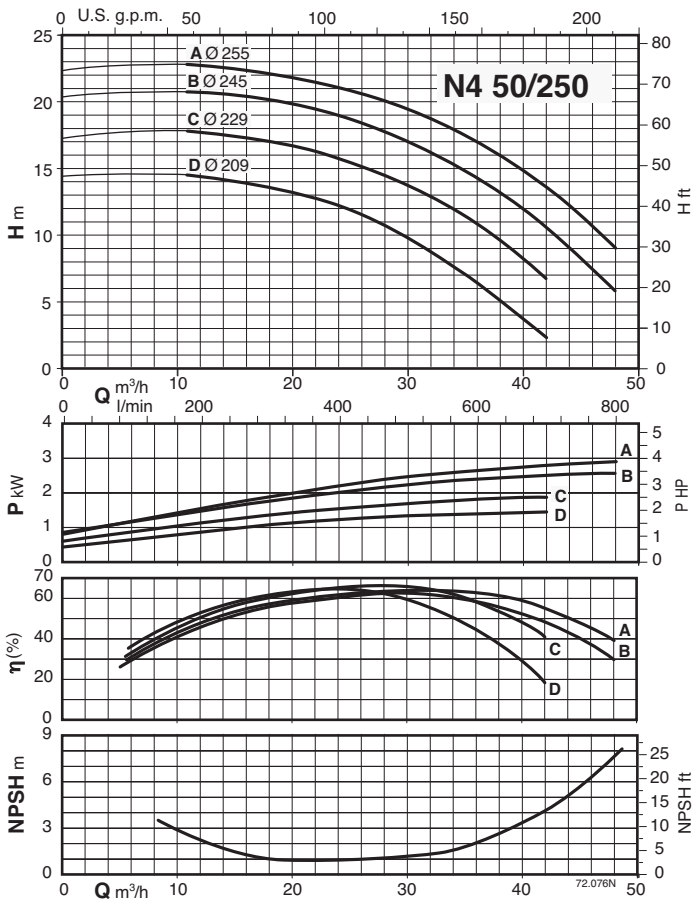
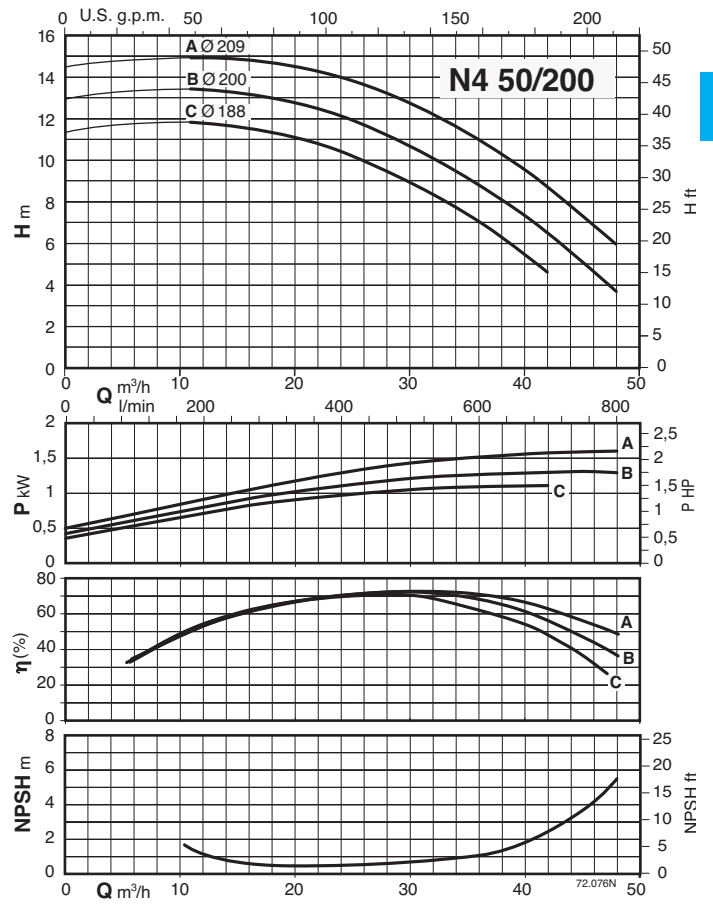
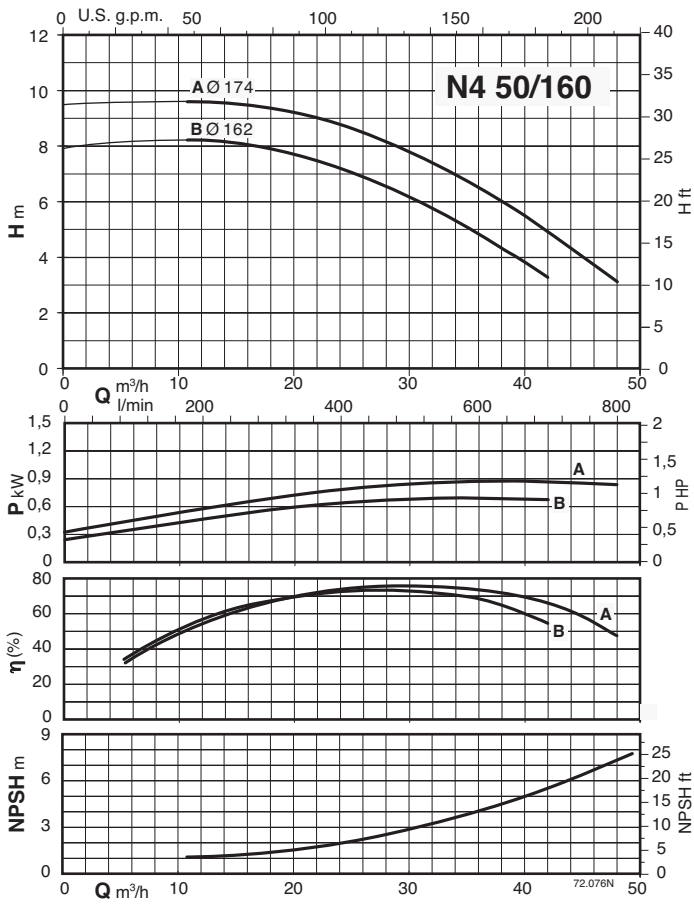

### Characteristic curves $n \approx 1450$ rpm

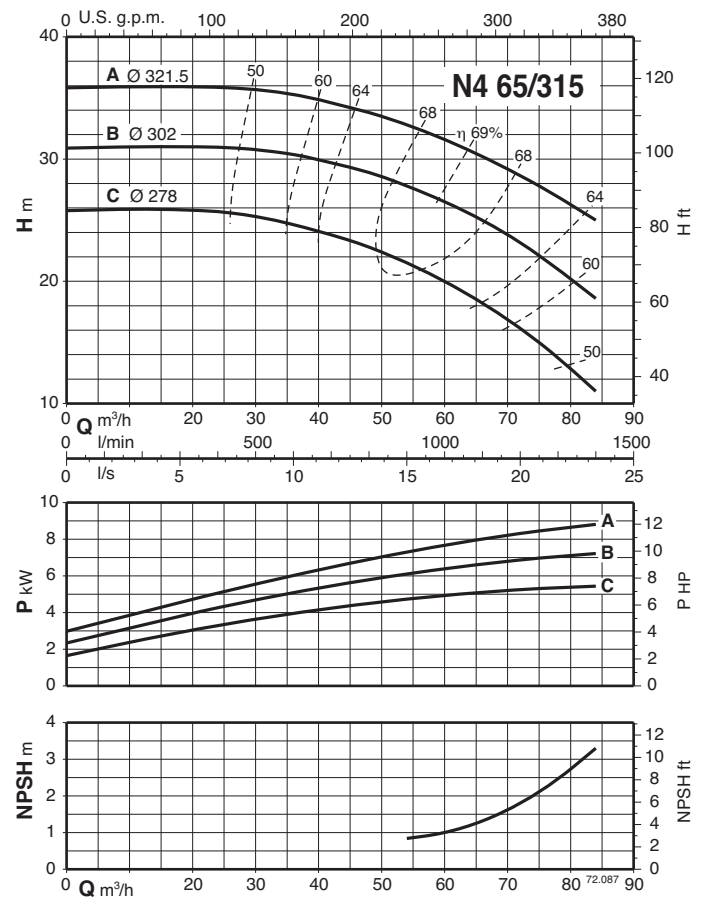
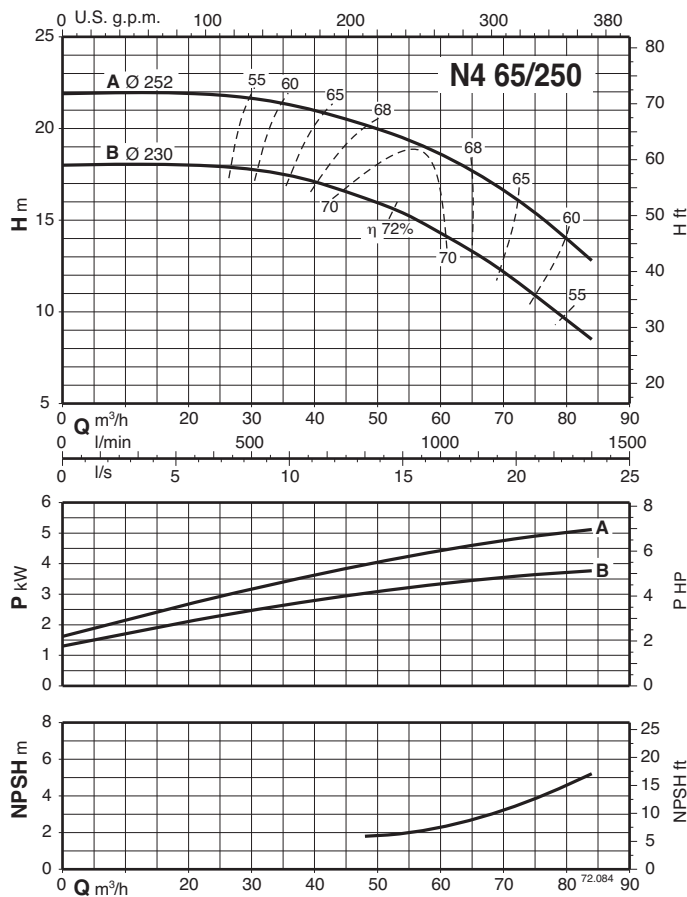
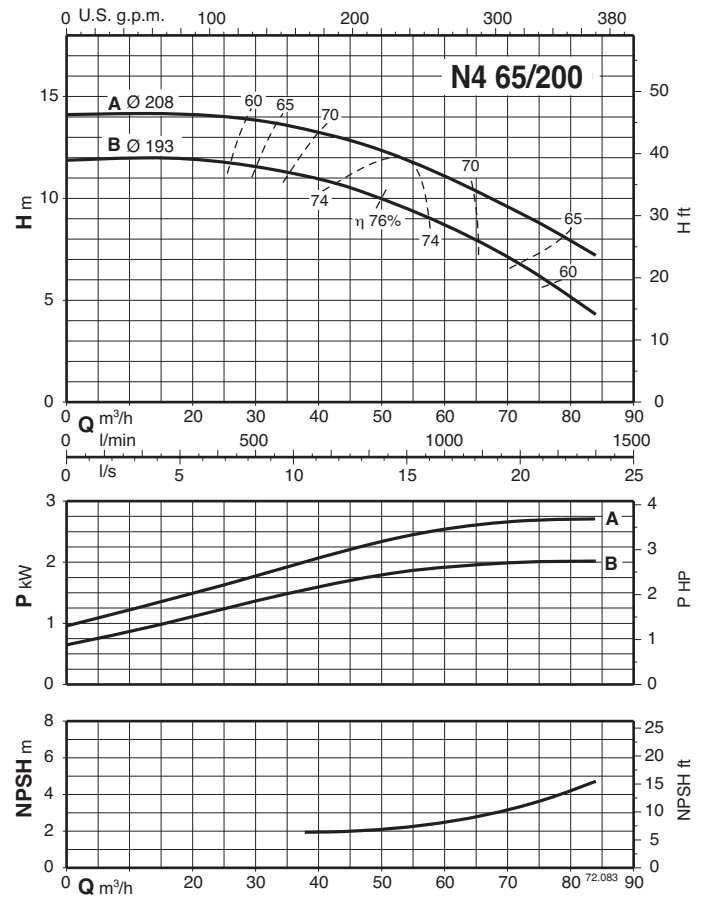
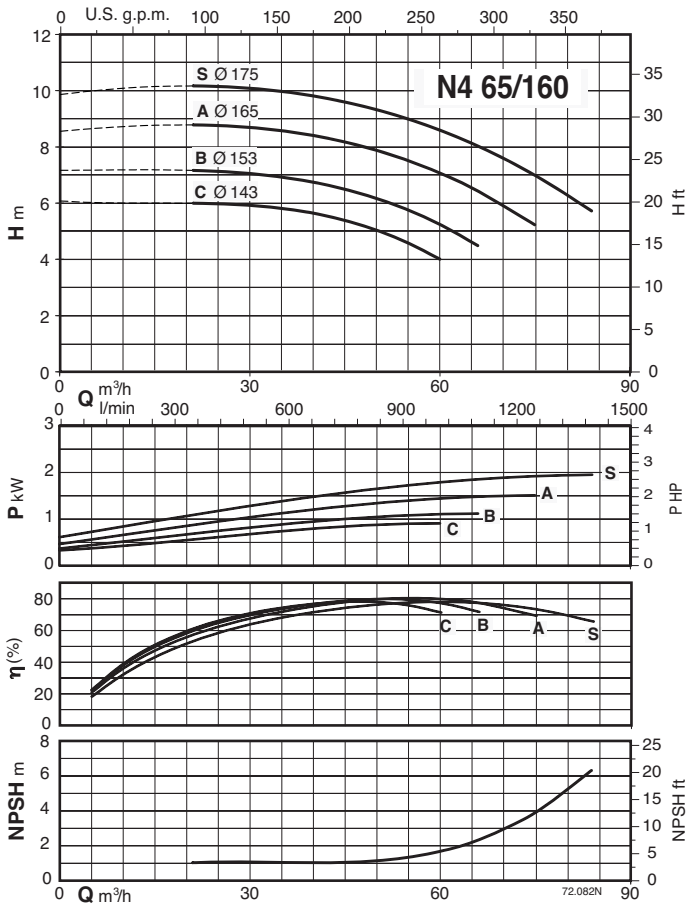

### Characteristic curves $n \approx 1450$ rpm

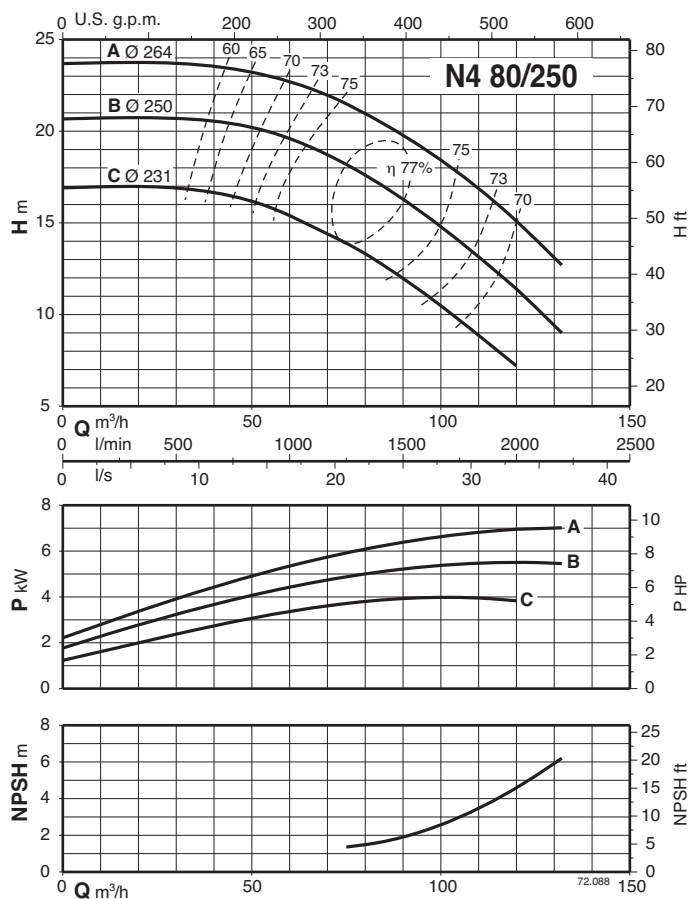
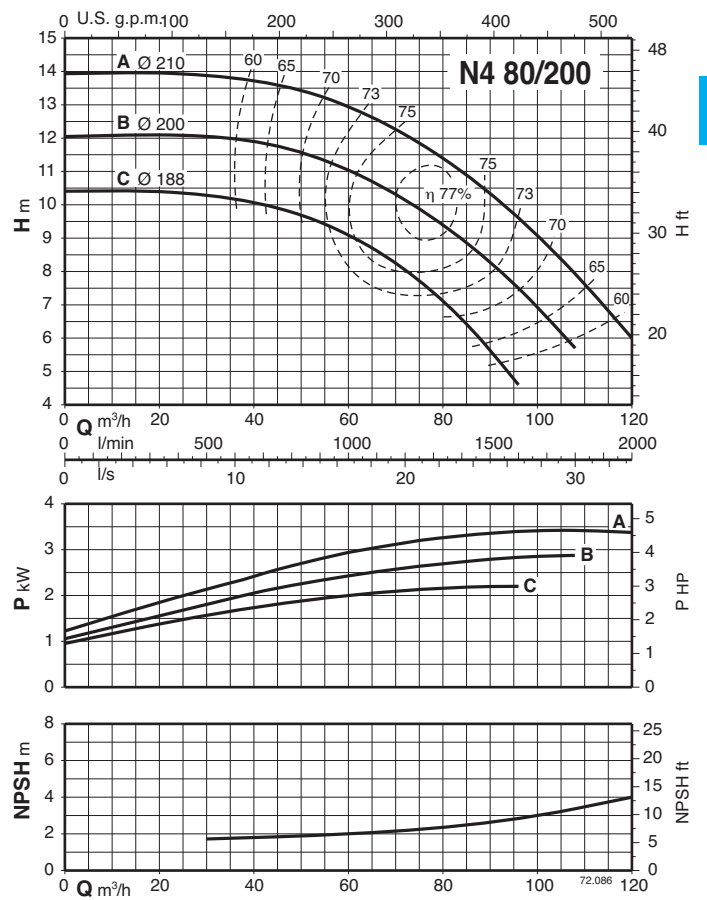
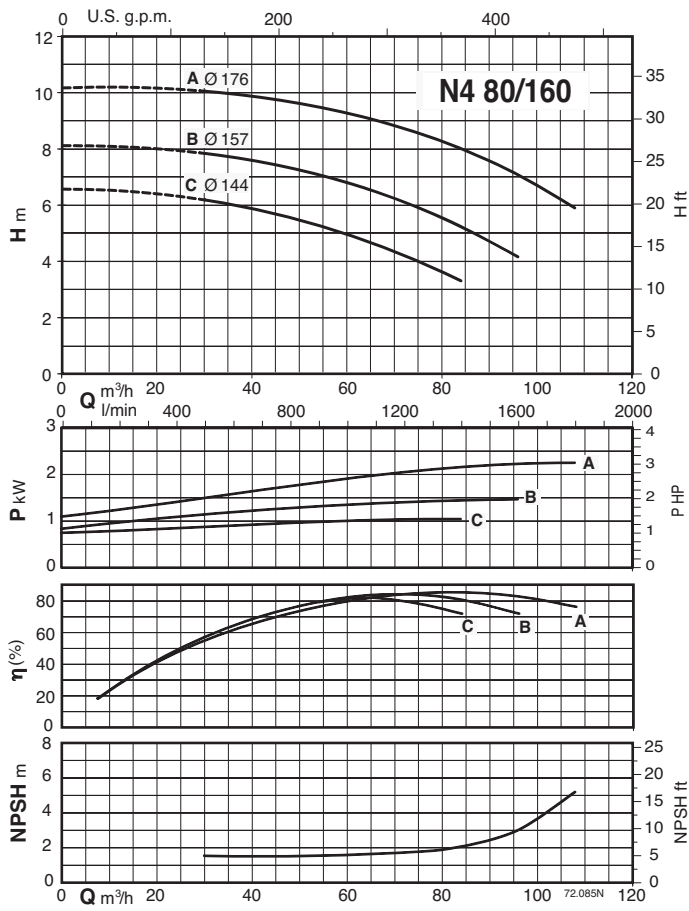

### Characteristic curves $n \approx 1450$ rpm

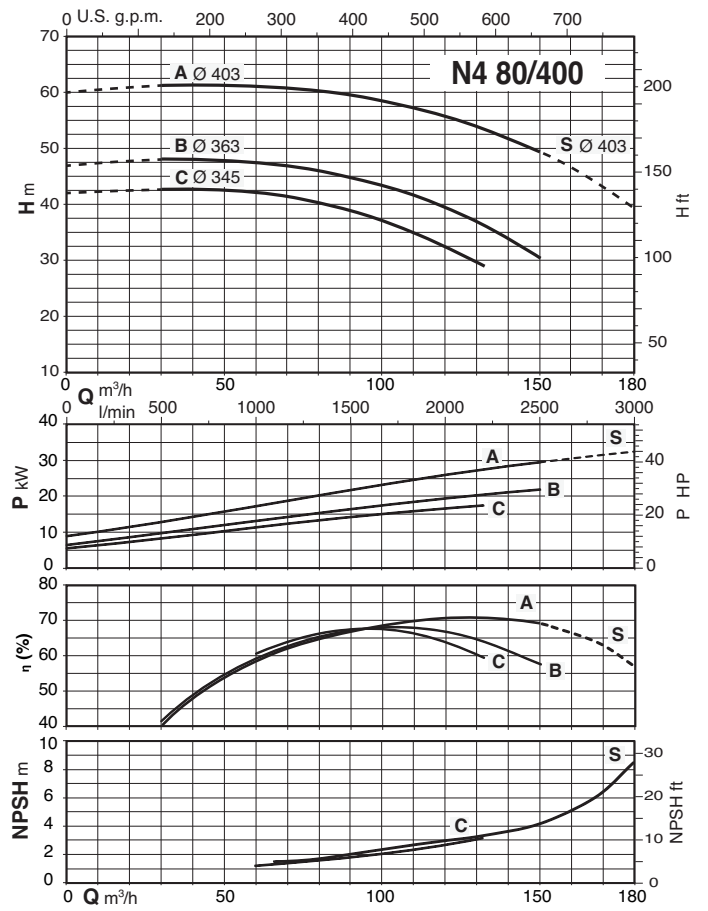
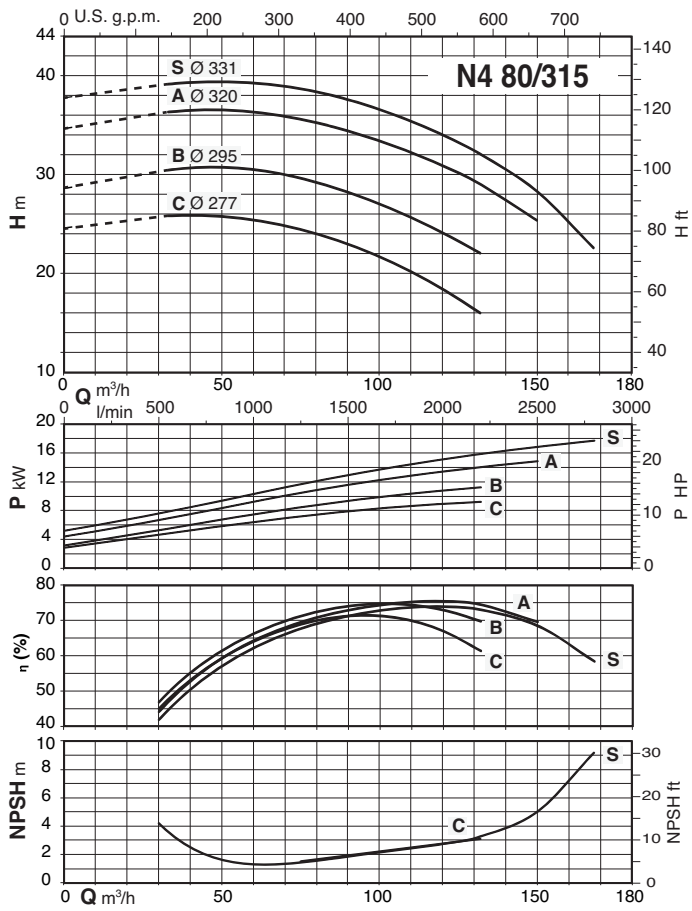



### Characteristic curves $n \approx 1450$ rpm

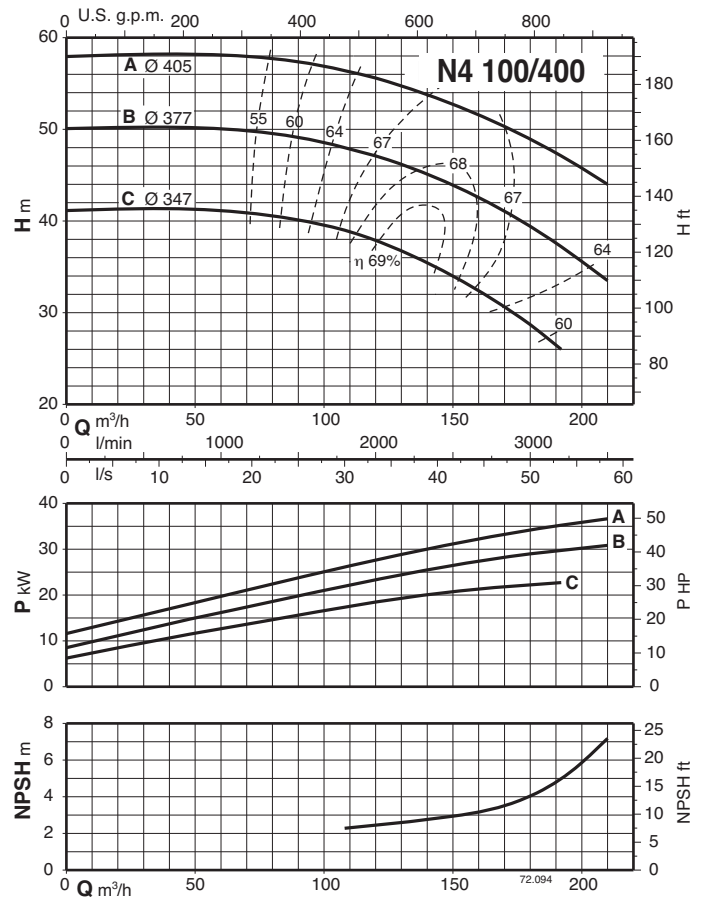
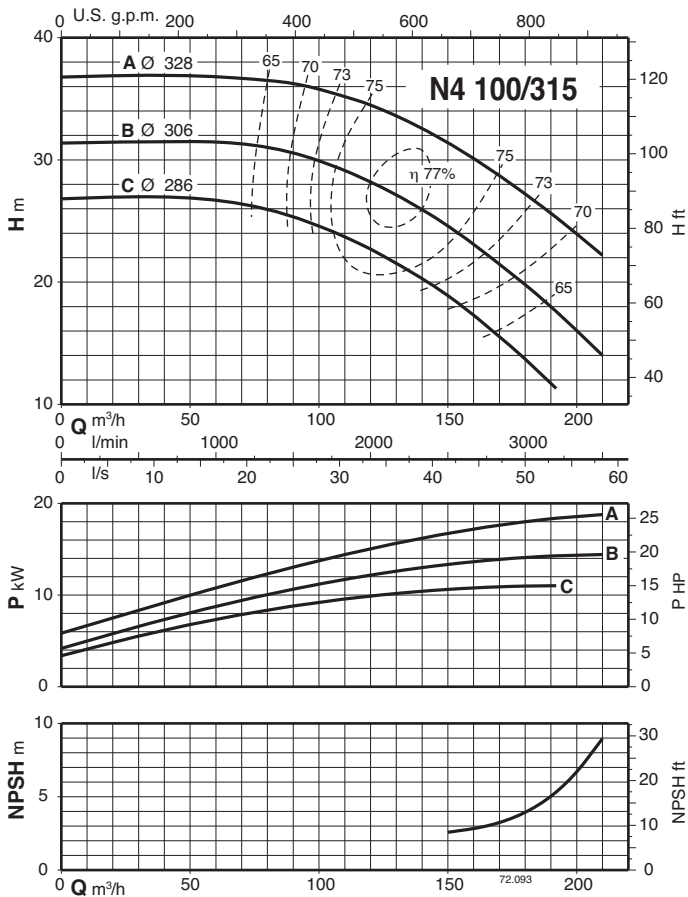
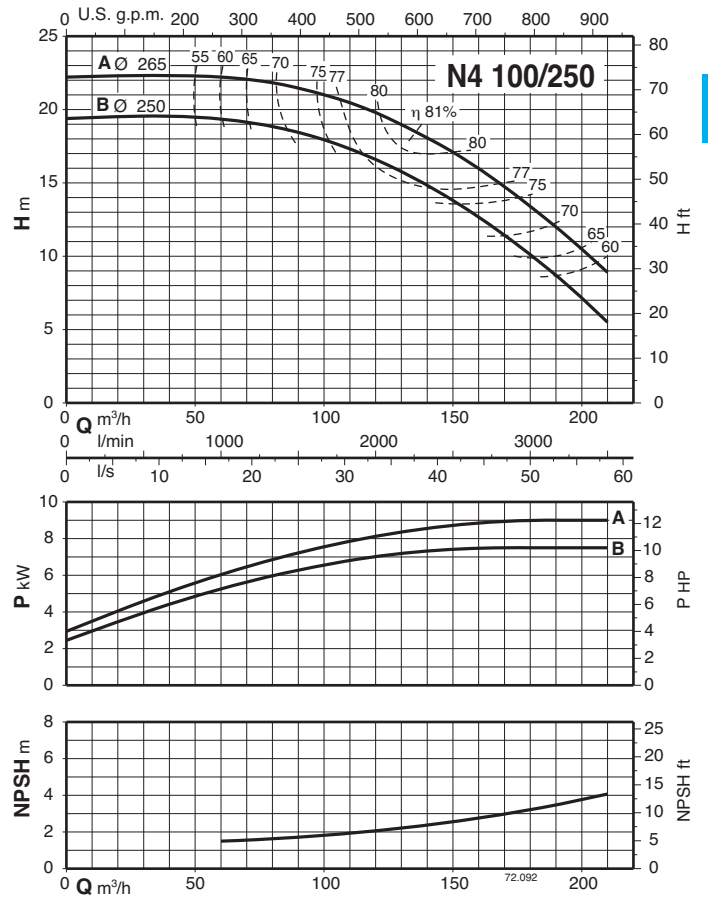
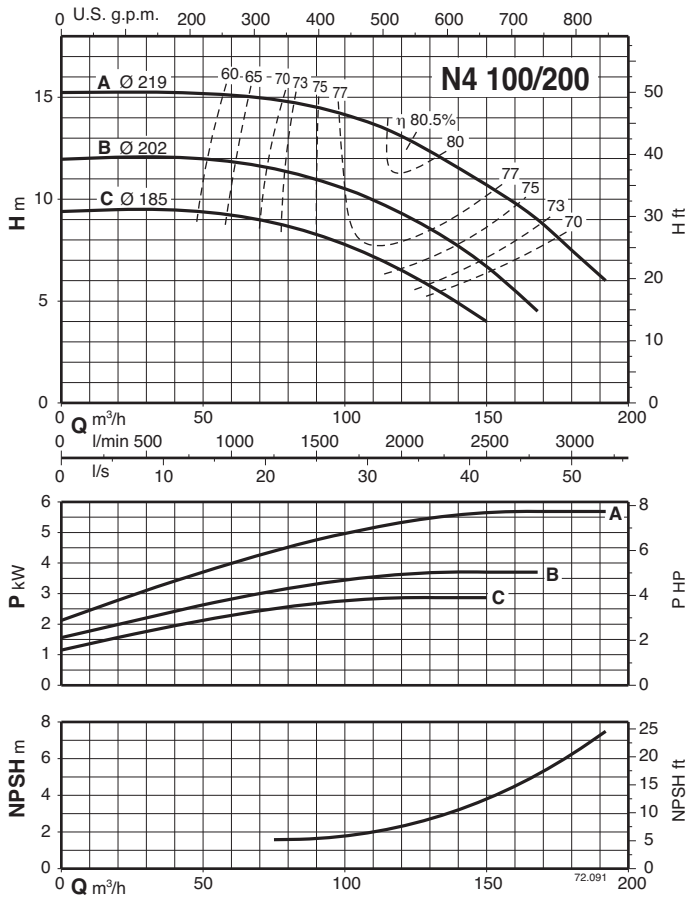

### Characteristic curves $n \approx 1450$ rpm

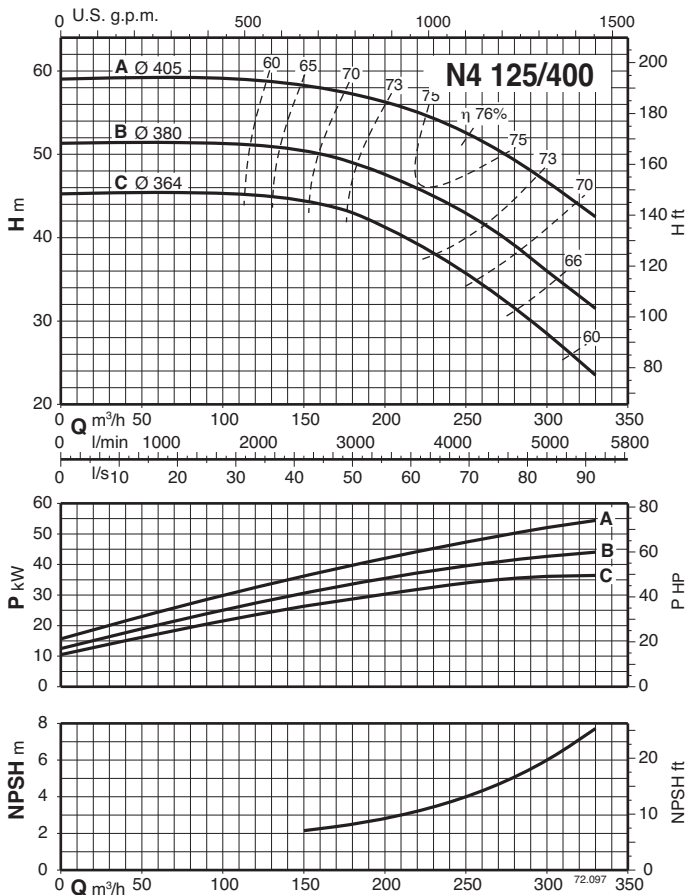
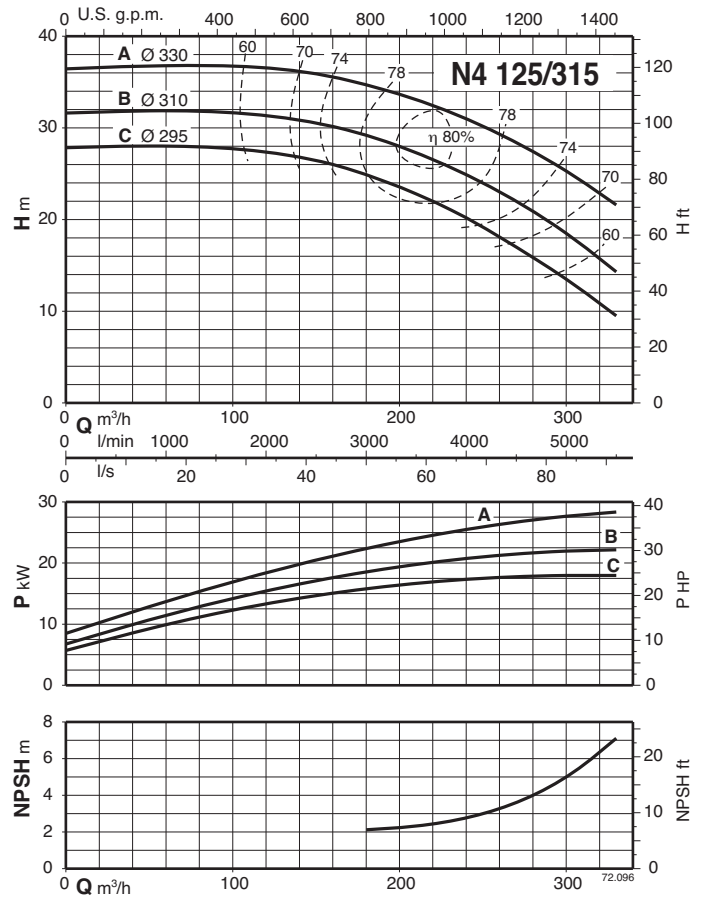
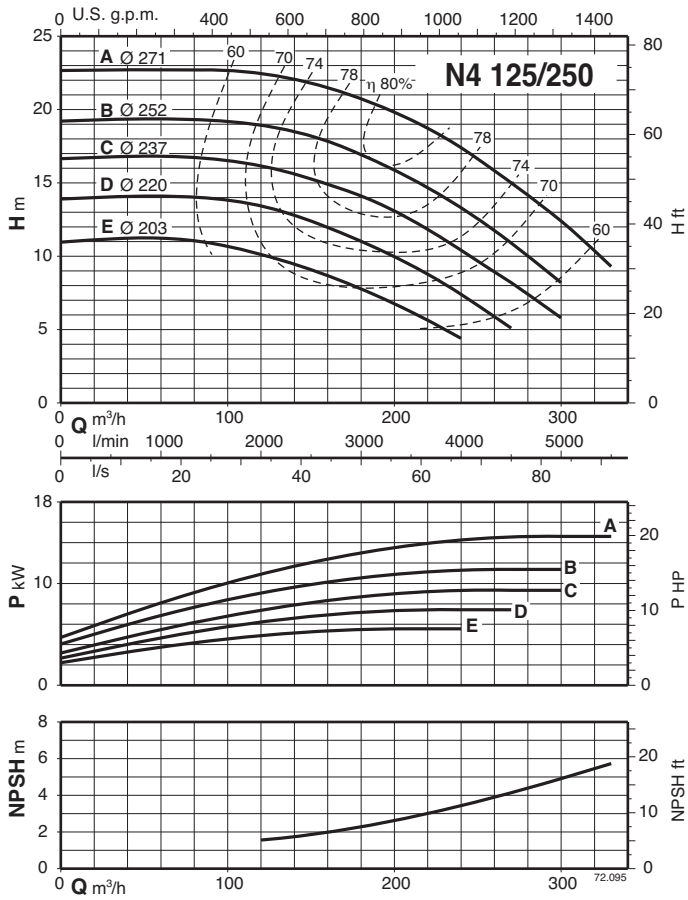

### Characteristic curves $n \approx 1450$ rpm

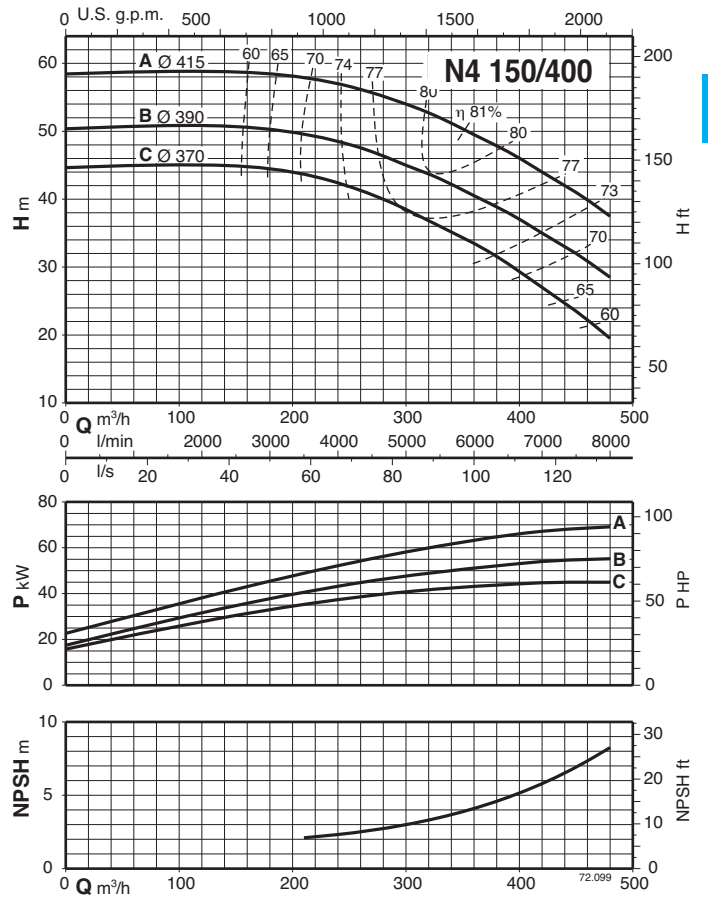
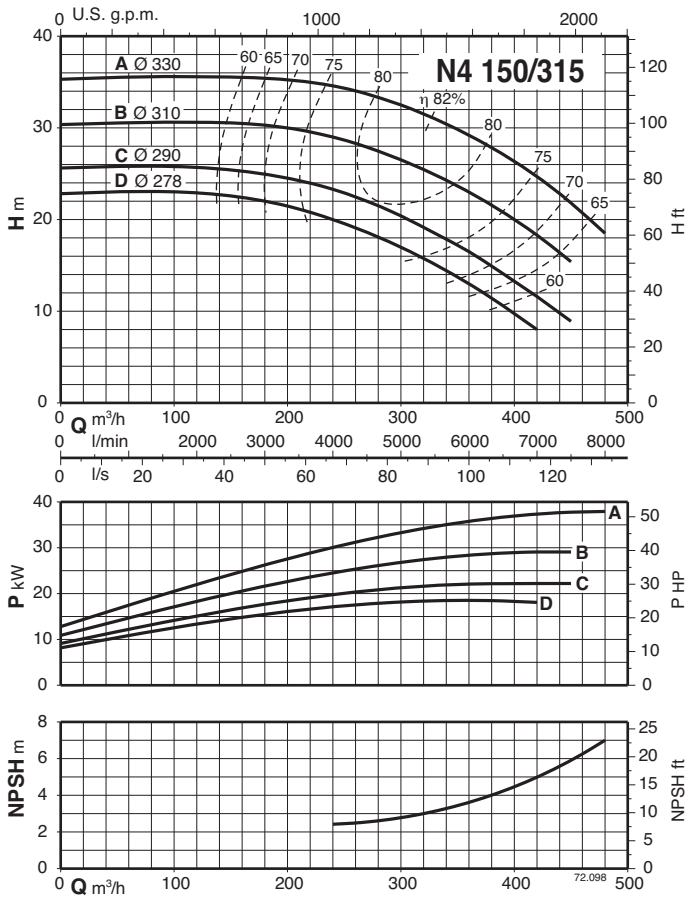

### Interchangeability of parts

TYPE	Bearing housing			Pump shaft					Ball bearings				Shaft sealing		
	1	2	3	I	II	III	IV	V	6207 Z 6306 Z	6207 Z 3306	6309 Z 3309	6311 Z 3311	Ø 32	Ø 40	Ø 50
N,N4 32-125	x			x					x				x		
N,N4 32-160	x				x				x				x		
N,N4 32-200	x				x				x				x		
N,N4 40-125	x				x				x				x		
N,N4 40-160	x				x				x				x		
N,N4 40-200C	x				x				x				x		
N,N4 40-200A-AR-B	x					x				x			x		
N,N4 40-250	x					x				x			x		
N,N4 50-125	x				x				x				x		
N,N4 50-160	x					x				x			x		
N,N4 50-200	x					x				x			x		
N,N4 50-250	x					x				x			x		
N,N4 65-125E	x				x				x				x		
N,N4 65-125A-C	x					x				x			x		
N,N4 65-160	x					x				x			x		
N,N4 65-200	x					x				x			x		
N,N4 65-250		x					x				x			x	
N4 65-315		x					x				x			x	
N,N4 80-160	x					x				x			x		
N,N4 80-200		x					x				x			x	
N,N4 80-250		x					x				x			x	
N4 80-315		x					x				x			x	
N4 80-400			x					x				x			x
N,N4 100-200		x					x				x			x	
N,N4 100-250		x					x				x			x	
N4 100-315		x					x				x			x	
N4 100-400			x					x				x			x
N4 125-250		x					x				x			x	
N4 125-315			x					x				x			x
N4 125-400			x					x				x			x
N4 150-315			x					x				x			x
N4 150-400			x					x				x			x

### Maximum permissible rotation speed

3600 rpm			3000 rpm			1800 rpm		
32-125	32-160	32-200						
40-125	40-160	40-200			40-250			
50-125	50-160	50-200			50-250			
65-125	65-160				65-250			
		80-200	80-160		80-250		65-315	
		100-200			100-250		80-315	80-400
							100-315	100-400
							125-315	125-400
							150-315	150-400

### Suction pipe: recommended minimum inside diameter (DN) for different capacities (Q)

Threaded pipe	DN	G 2 G 2 1/2													
		mm	50	65	80	100	125	150	200	250	300				
Q max	m³/h	10,5	19	28,8	45	75	108	215	350	508					

### Dimensions and weights

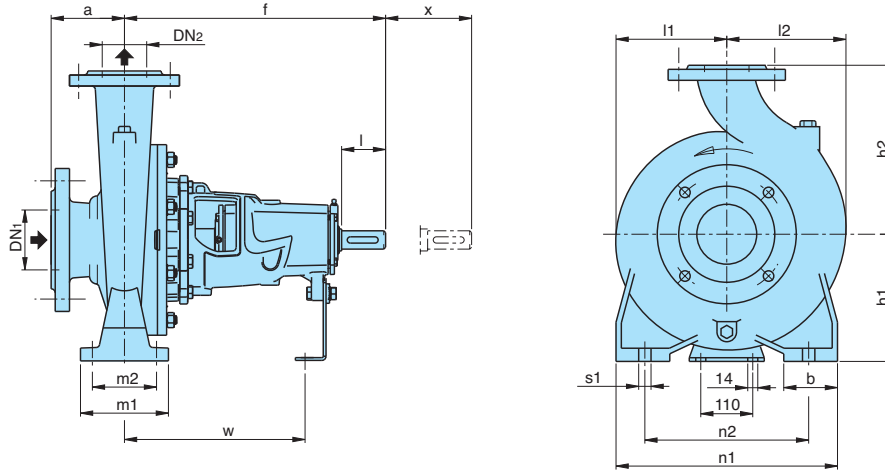

Shaft extension ISO 775 Parallel key UNI 6604

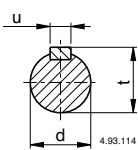

mm			
d	l	u	t
24 j6	50	8	27
32 k6	80	10	35
42 k6	110	12	45

Flanges PN 10, EN 1092-2

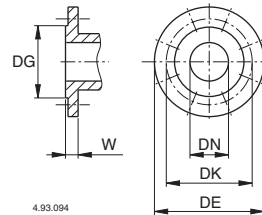

mm						
DN	DG	DK	DE	Holes		W
				N°	Ø	
32	76	100	140	4	19	18
40	84	110	150	4	19	18
50	99	125	165	4	19	20
65	118	145	185	4	19	20
80	132	160	200	8	19	22
100	156	180	220	8	19	24
125	184	210	250	8	19	24
150	211	240	285	8	23	26
200	266	295	340	8	23	30

**N** n ≈ 2900 rpm  
**N4** n ≈ 1450 rpm

TYPE	mm																kg		
	DN1	DN2	a	f	h1	h2	l1	l2	m1	m2	n1	n2	b	s1	d	w	x	B-N	N
B-N, B-N4 - N, N4 32-125	50	32	80	360	112	140	93	97	100	70	190	140	50	14	24	260	100	30	26,5
B-N, B-N4 - N, N4 32-160					132	160	120	120			240	190						37	33
B-N, B-N4 - N, N4 32-200					160	180	140	140										44	38,4
B-N, B-N4 - N, N4 40-125	65	40	80	360	112	140	100	113	100	70	210	160	50	14	24	260	100	32	28,4
B-N, B-N4 - N, N4 40-160			132		160	119	119	240			190	38						33,6	
B-N, B-N4 - N, N4 40-200			160		180	140	140	265			212	47,1						40,4	
B-N, B-N4 - N, N4 40-250			180		225	175	175	320			250	63						55	
B-N, B-N4 - N, N4 50-125	65	50	100	360	132	160	121	137	100	70	240	190	50	14	24	260	100	42,4	36,5
B-N, B-N4 - N, N4 50-160					160	180	127	141			265	212						45	39,2
B-N, B-N4 - N, N4 50-200					160	200	140	153										54	47
B-N, B-N4 - N, N4 50-250					180	225	175	175			320	250						66	57,5
B-N, B-N4 - N, N4 65-125	80	65	100	360	160	180	134	155	125	95	280	212	65	14	24	260	100	48	38,7
B-N, B-N4 - N, N4 65-160					180	200	150	172			320	250						50,6	44,5
B-N, B-N4 - N, N4 65-200					180	225	155	175										55,5	50
B-N, B-N4 - N, N4 65-250					200	250	175	190			360	280						103	90
B-N4 - N4 65-315					225	280	220	220			400	315						149	130
B-N, B-N4 - N, N4 80-160					100	80	125	360			180	225						165	193
B-N, B-N4 - N, N4 80-200	180	250	170	194				345	280	93	80,5								
B-N, B-N4 - N, N4 80-250	200	280	191	210						110	95								
B-N4 - N4 80-315	250	315	220	232				400	315	154	134								
B-N4 - N4 80-400 (1)	125	80	125	530	280	355	268	268	160	120	435	355	80	18	42	370	140	220	192
B-N, B-N4 - N, N4 100-200	125	100	125	470	200	280	180	212	160	120	360	280	80	18	32	340	140	103	89
B-N, B-N4 - N, N4 100-250			225		315	205	233	400			315	123						104	
B-N4 - N4 100-315			250		315	230	250					158						138	
B-N4 - N4 100-400			530		280	355	268	280			200	150						500	400
B-N4 - N4 125-250	150	125	140	470	250	355	235	268	160	120	400	315	80	18	32	340	140	150	129
B-N4 - N4 125-315				280	400	247	278					217						189	
B-N4 - N4 125-400				315	400	280	305					255						222	
B-N4 - N4 150-315				280	400	260	298					231						201	
B-N4 - N4 150-400	200	150	160	530	315	450	295	328	200	150	550	450	100	22	42	370	140	284	247

1) Additional size







## Features

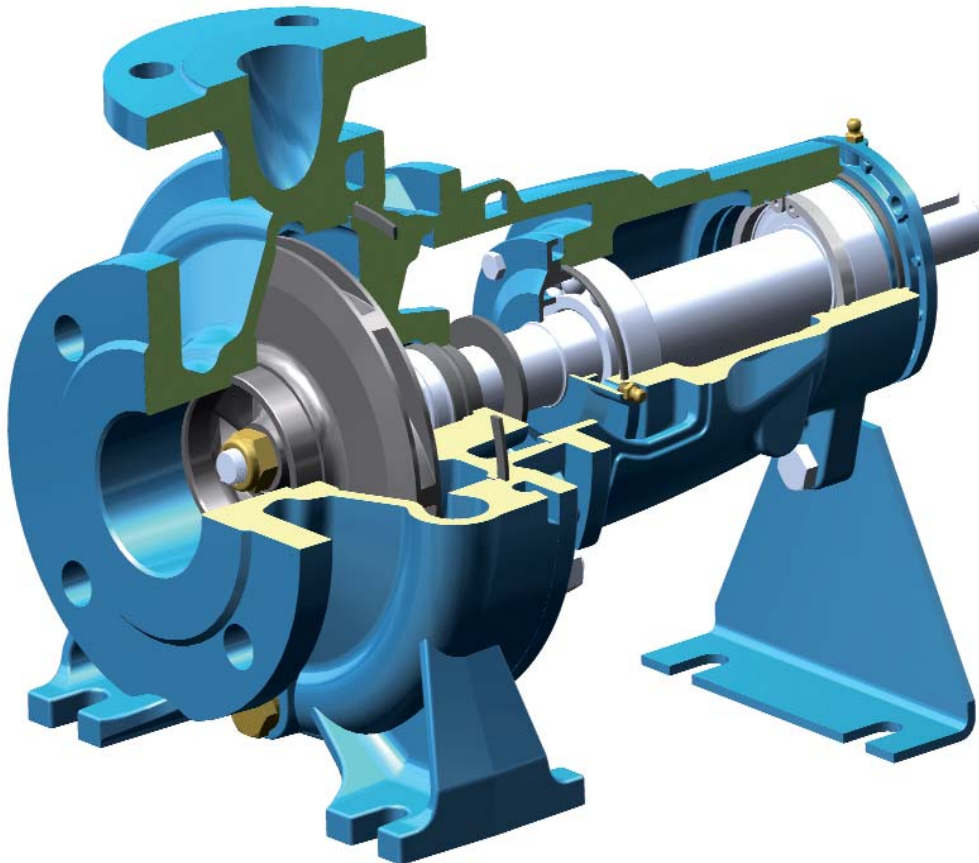

### Cutting edge hydraulics

The geometry of the impeller and the pump casing are optimized to achieve maximum efficiency and the best suction capability.

### Flexible

The option to choose between cast iron and bronze materials for the hydraulic parts in contact with the pumped liquid allows N-N4 series pumps to be selected for use with different types of liquids.

### Robust

The mechanical structure of the hydraulic parts in contact with the pumped liquid are dimensioned to guarantee the maximum resistance to mechanical stress. Also the casing cover is provided with wings that prevent turbulence in the area of the mechanical seal, increasing the reliability.

### Reliable

The bearing and shaft are designed to ensure the reduction of the stress, providing high reliability under all operating conditions.