



Construction

Close-coupled peripheral pumps (regenerative pumps) with turbine impeller.

T, TP: version with pump casing and lantern bracket in cast iron.
 B-T, B-TP: version with pump casing and lantern bracket in bronze (the pumps are supplied fully painted).

Applications

For clean liquids without abrasives, without suspended solids, non-explosive, non-aggressive for the pump materials.
 For increasing network pressure (follow local specifications).
 For the reduced dimensions, these pumps are very well suitable to be mounted in cooling and air-conditioning machines and equipments, circulation, boiler feed.

Operating conditions

Liquid temperature from -10 °C to +90 °C.
 Ambient temperature up to 40 °C.
 Total suction lift up to 7 m.
 Continuous duty.

Motor

2-pole induction motor, 50 Hz ($n \approx 2900$ rpm).

T, TP: three-phase 230/400 V $\pm 10\%$ up to 3 kW;
 400/690 V $\pm 10\%$ from 4 to 7,5 kW;

TM, TPM: single-phase 230 V $\pm 10\%$ with thermal protector.
 Capacitor inside the terminal box.

Insulation class F.

Protection IP 54.

Classification scheme IE3 for three-phase motors from 0,75 kW.

Constructed in accordance with: EN 60034-1; EN 60034-30.
 EN 60335-1, EN 60335-2-41.

Materials

Components	T, TP	B-T, B-TP
Pump casing	Cast iron	Bronze
Lantern bracket	GJL 200 EN 1561	G-Cu Sn 10 EN 1982
Casing cover	Cast iron	Bronze
	GJL 200 EN 1561	G-Cu Sn 10 EN 1982
	Brass P- Cu Zn Pb 40 2 UNI 5705 for T 61-65-70, B-T 61-70	
Impeller	Brass P- Cu Zn 40 Pb 2 UNI 5705	
	Bronze G-Cu Sn 10 EN 1982 for T 125, TP 132-132R	
Shaft	Cr-Ni steel AISI 303 T 76, Tp 80-100	Cr-Ni-Mo steel AISI 316
	Chrome steel AISI 430 T 61-65-70-100-125, Tp 78-132-132R	
Mechanical seal	Carbon - Ceramic - NBR	

Special features on request

- Other voltages.
- Frequency 60 Hz (as per 60 Hz data sheet).
- Protection IP 55.
- Special mechanical seal.
- Higher or lower liquid or ambient temperatures.
- Construction with bearing bracket.

Coverage chart $n \approx 2900$ rpm

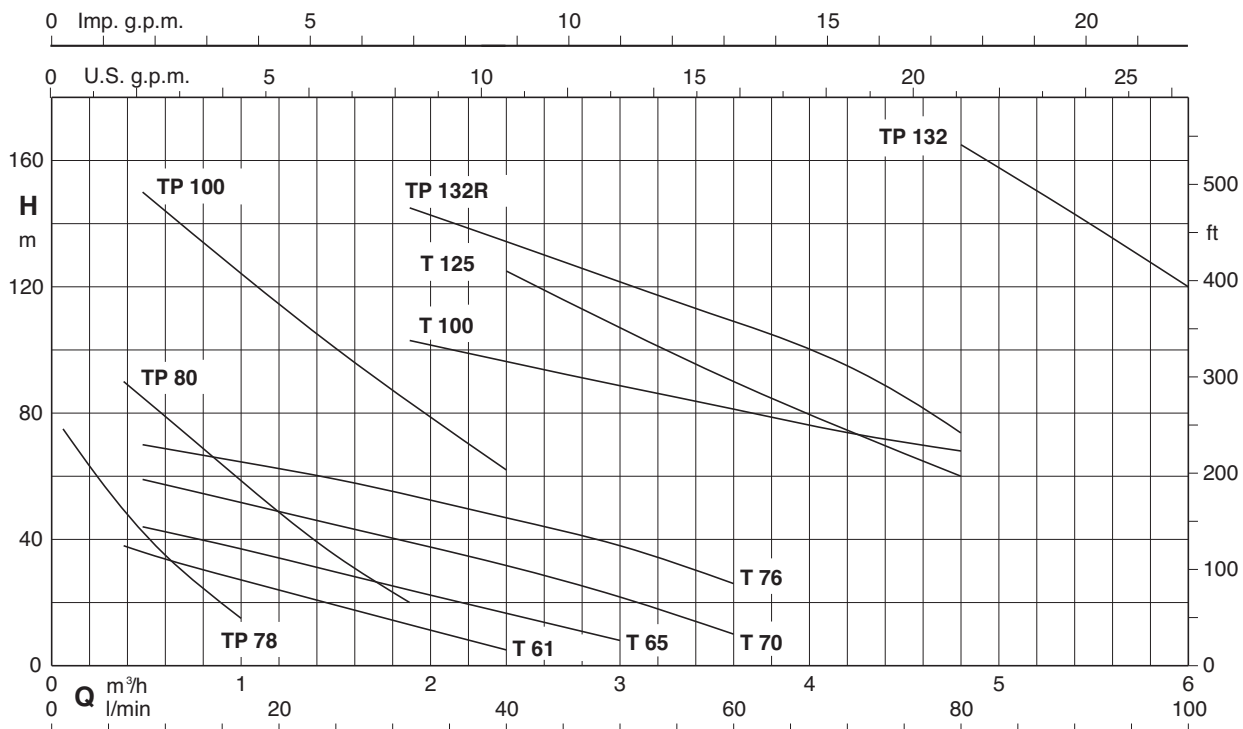

Performance n ≈ 2900 rpm

3 ~	230V 400V		1 ~	230V		P ₁	P ₂	Q m ³ /h																				
	A	A		A	kW	kW	HP		l/min	1	2	4	6,3	8	10	12,5	16	20	25	31,5	40	50	60	70	80	90	100	
B- T 61E	1,9	1,1	B- TM 61E	2,5	0,55	0,33	0,45	H m																				
B- T 65E	2,8	1,6	B- TM 65E	3,5	0,8	0,45	0,6							38	36	34	31,5	28	24	19	12,5	5						
B- T 70/B	3,7	2,2	B- TM 70/A	6	1,3	0,75	1							44	42	40	37	33	29	24	16	8						
T 76/A	5,3	3	TM 76E	7,4	1,6	1,1	1,5							59	57	55	51	48	43	38	30	22	10					
T 100/A	11,5	6,6				3	4							70	68	67	65	62	58	53	46	38	26					
T 125/B		9,6				4	5,5													103	97	89	82	75	68			
B- TP 78/A	2,3	1,3	B- TPM 78/A	2,8	0,6	0,37	0,5														125	110	90	75*	60*			
B- TP 80E	4	2,3	B- TPM 80E	5,8	1,2	0,75	1							75	70	60	50	42	35	25	15							
TP 100/B	9,6	5,5				2,2	3														90	85	79	73	61	48	34	20
TP 132R/A		10,9				5,5	7,5														160	157	151	140	129	115	99	82
TP 132/A		14,3				7,5	10																					
									165 143* 120*																			

P1 Maximum power input.

B-T, B-TM = Bronze construction.

H Total head in m.

* Maximum suction lift 2-3 m.

P2 Rated motor power output.

Dimensions and weights

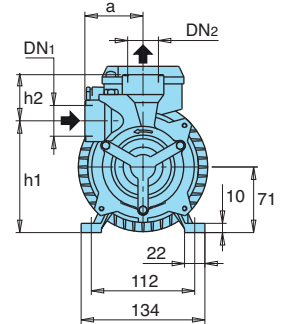
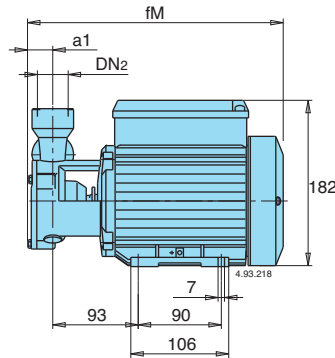
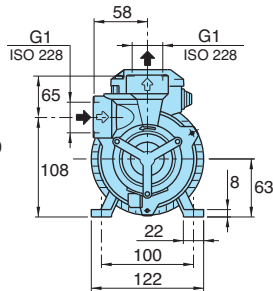
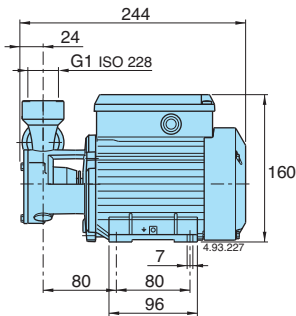

T 61E: kg 6,3
B- T 61E: kg 6,5

T 65E: kg 7,3
B- T 65E: kg 7,5

TYPE	DN1	DN2	mm						kg	
			ISO 228	a1	fM	h2	h1	a	T	B-T
T 70/B B-T 70/B	G 1	G 1	24	278	50	121	63	12	12,4	
TP 78/A B-TP 78/A	G 1/2	G 1/2	22	276	24	127	56	8,2	8,8	

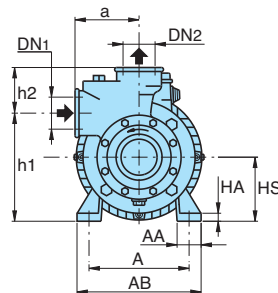
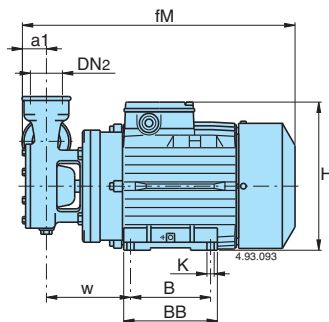

TYPE	DN1	DN2	mm															kg		
			ISO 228	a1	fM	HS	h2	h1	H	BB	B	AB	A	AA	K	a	w	HA	T, TP	B-TP
T 76/A	-	G 1 1/4	G 1 1/4	26	338	80	56	136	208	117	100	155	125	30	9	80	105	10	18,4	-
T 100/A	-	G 1 1/4	G 1 1/4	32	410	90	59	161	226	152	125	180	140	40	9,5	95	121	12	32,5	-
T 125/B	-	G 1 1/4	G 1 1/4	32	470	90	75	170	226	152	125	180	140	40	9,5	90	195	12	39,5	-
TP 80E B-TP 80E	-	G 3/4	G 3/4	27	332	80	35	135	208	117	100	155	125	30	9	60	104	10	16,4	16,8
TP 100/B	-	G 3/4	G 3/4	27	387	80	38	142	208	117	100	155	125	30	9	65	113	10	23,2	-
TP 132R/A	-	G 1 1/4	G 1 1/4	42	485	112	70	202	272	180	140	230	190	50	11,5	100	183	14	53,6	-
TP 132/A	-	G 1 1/4	G 1 1/4	42	485	112	70	202	272	180	140	230	190	50	11,5	100	183	14	58,5	-

Characteristic curves $n \approx 2900$ rpm

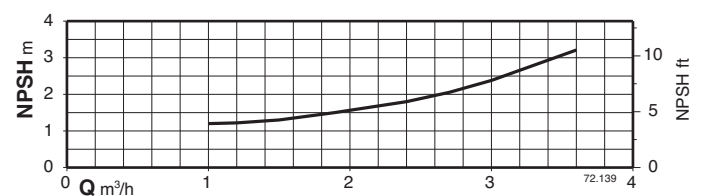
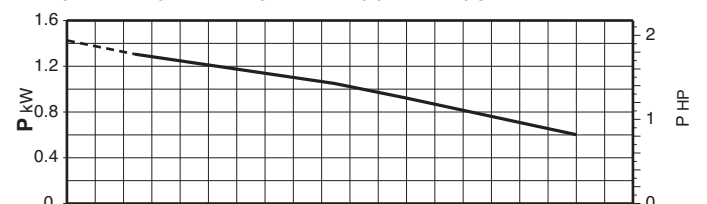
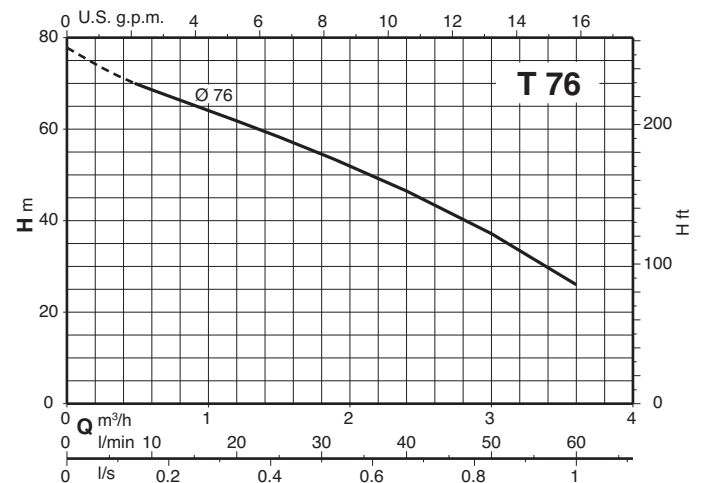
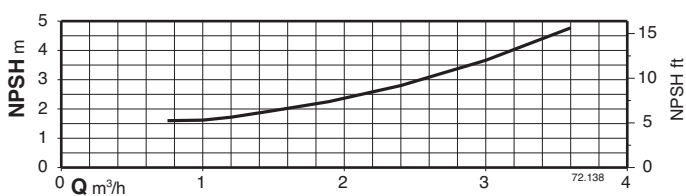
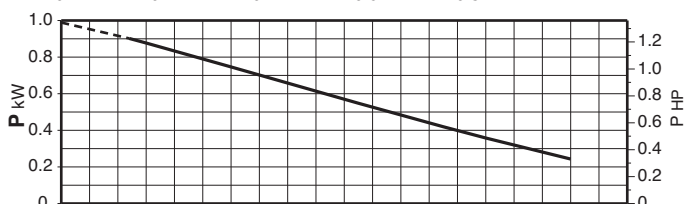
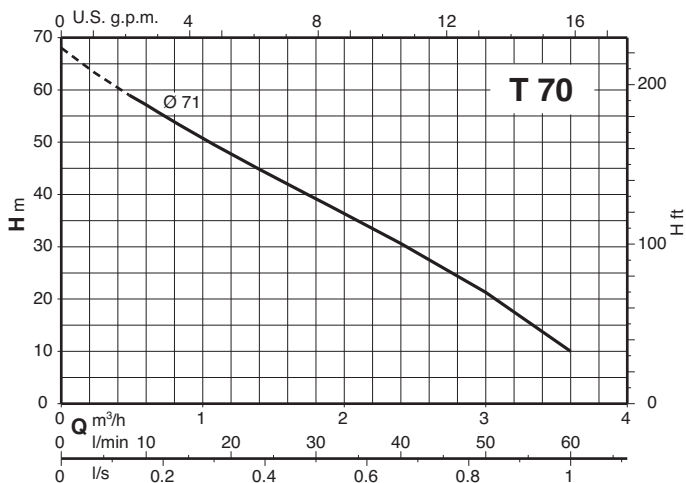
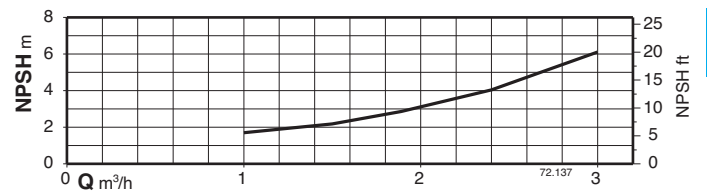
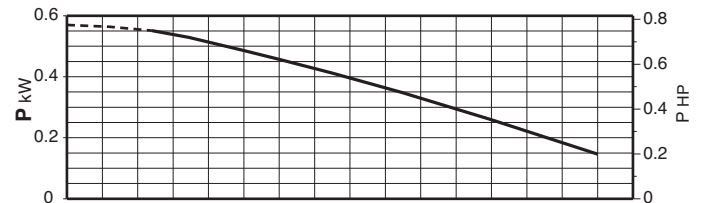
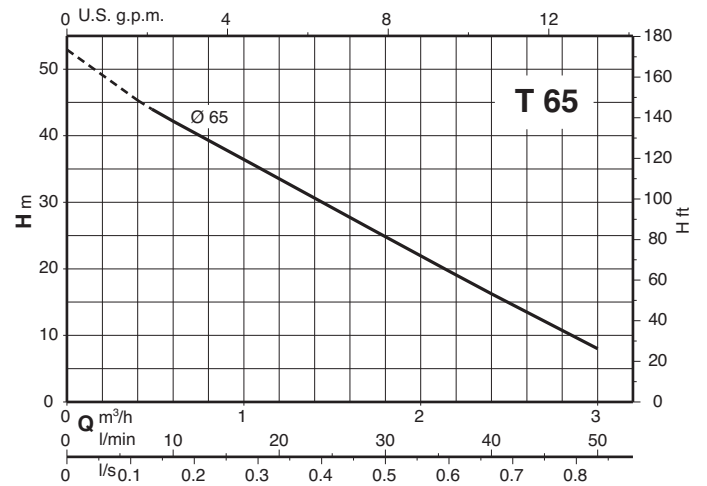
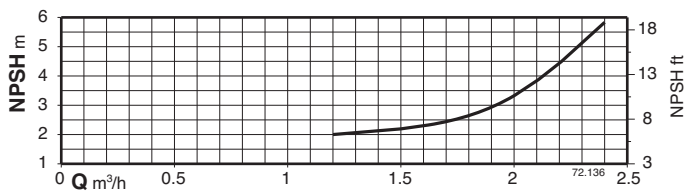
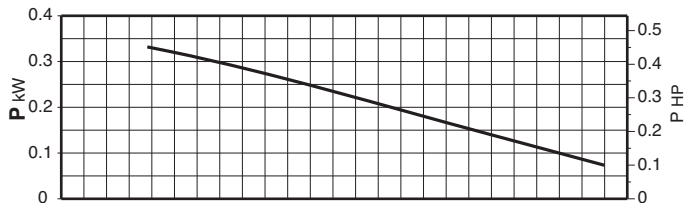
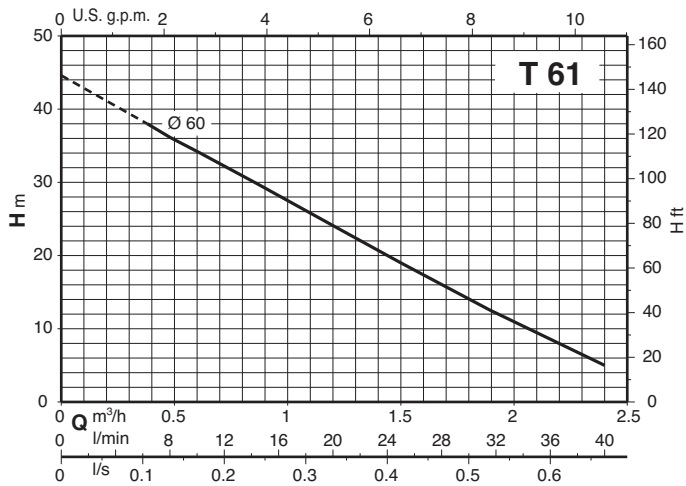

Characteristic curves $n \approx 2900$ rpm

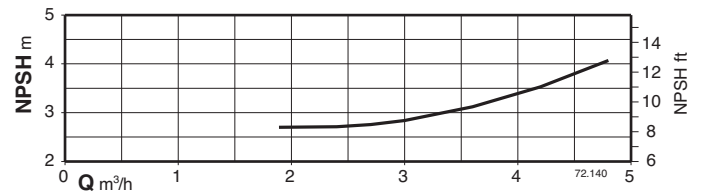
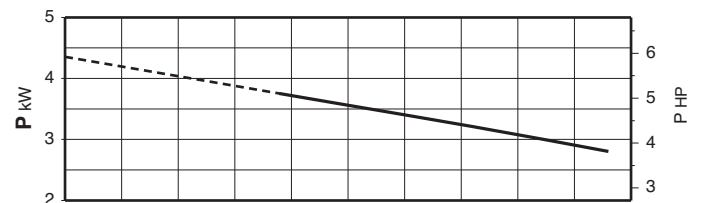
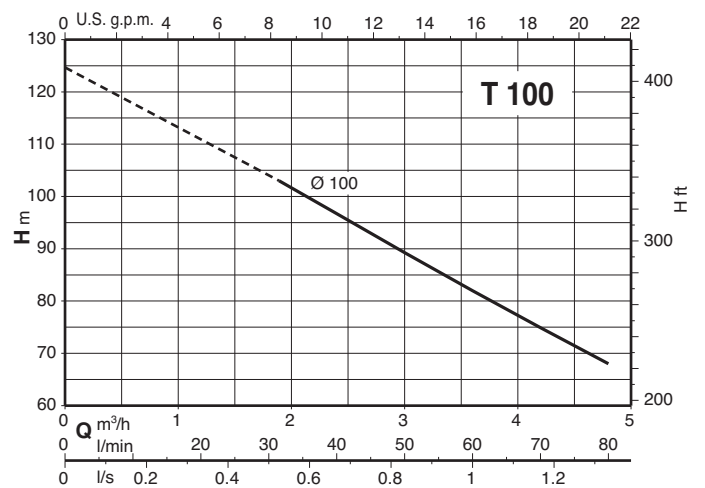
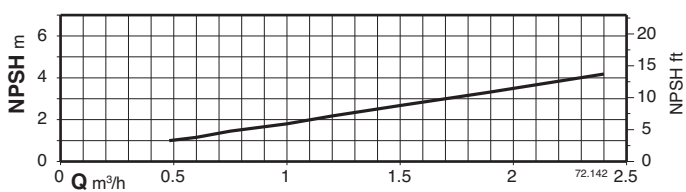
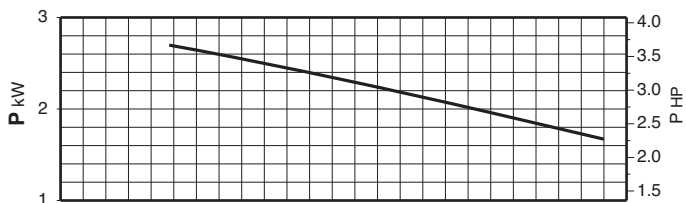
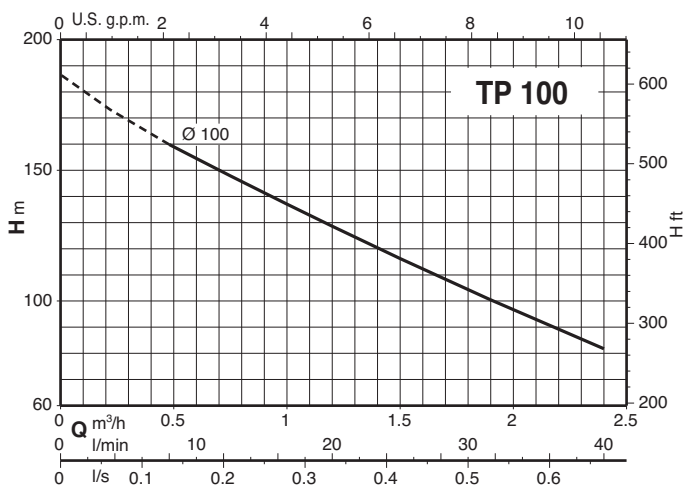
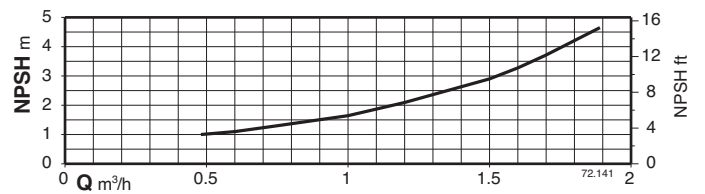
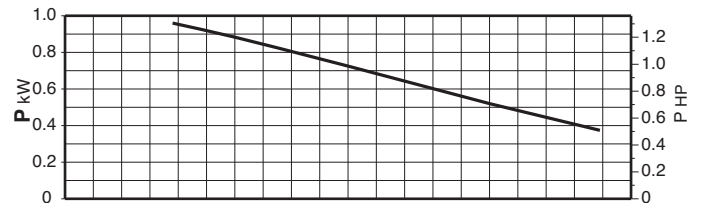
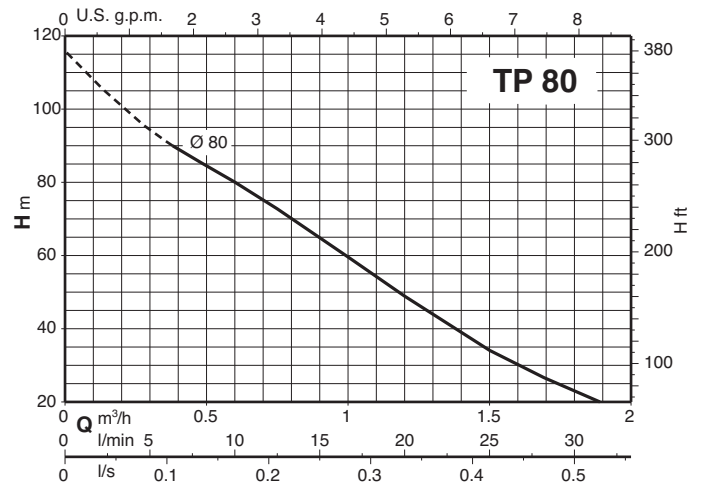
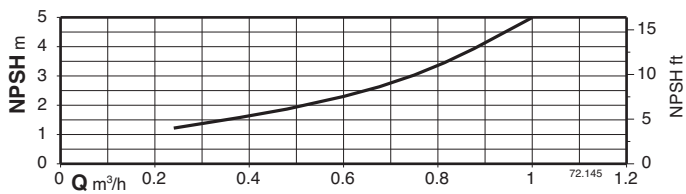
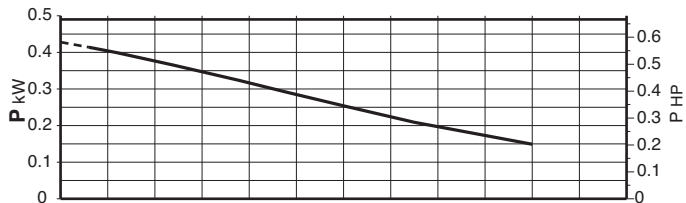
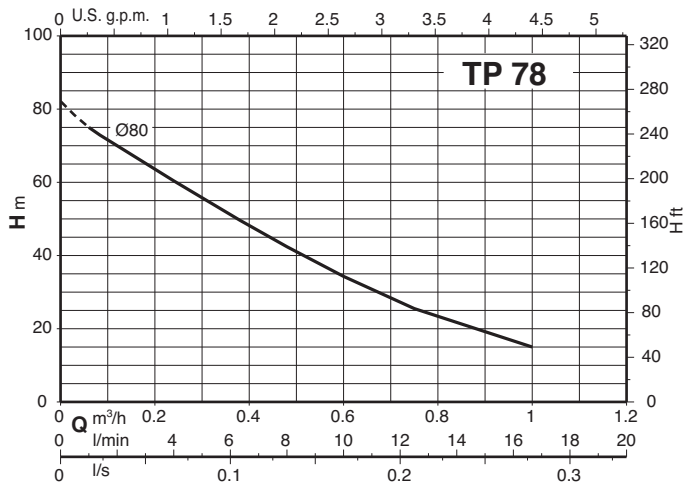

Characteristic curves $n \approx 2900$ rpm

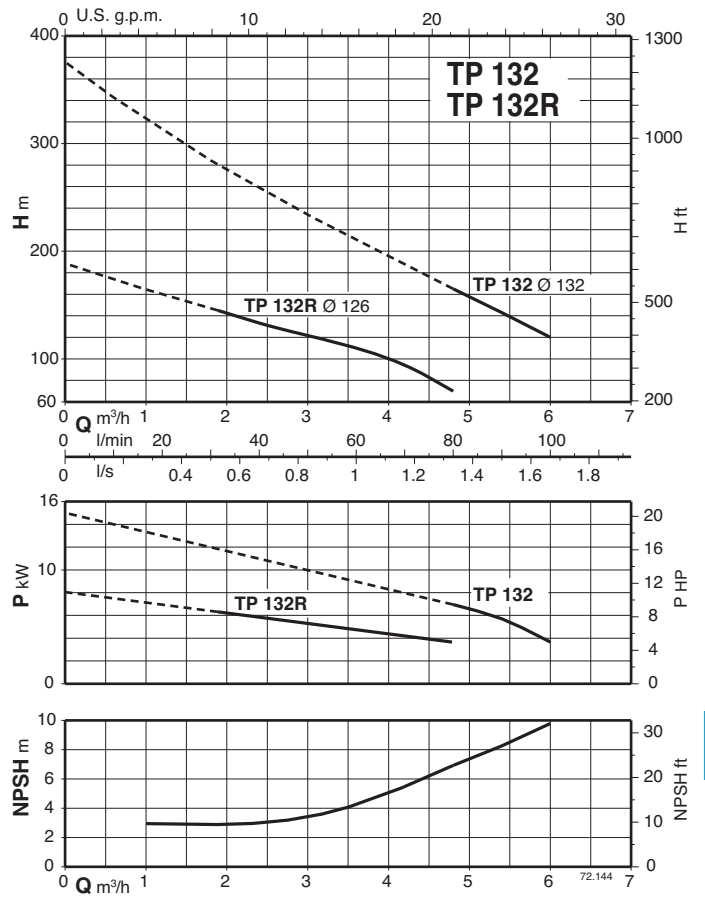
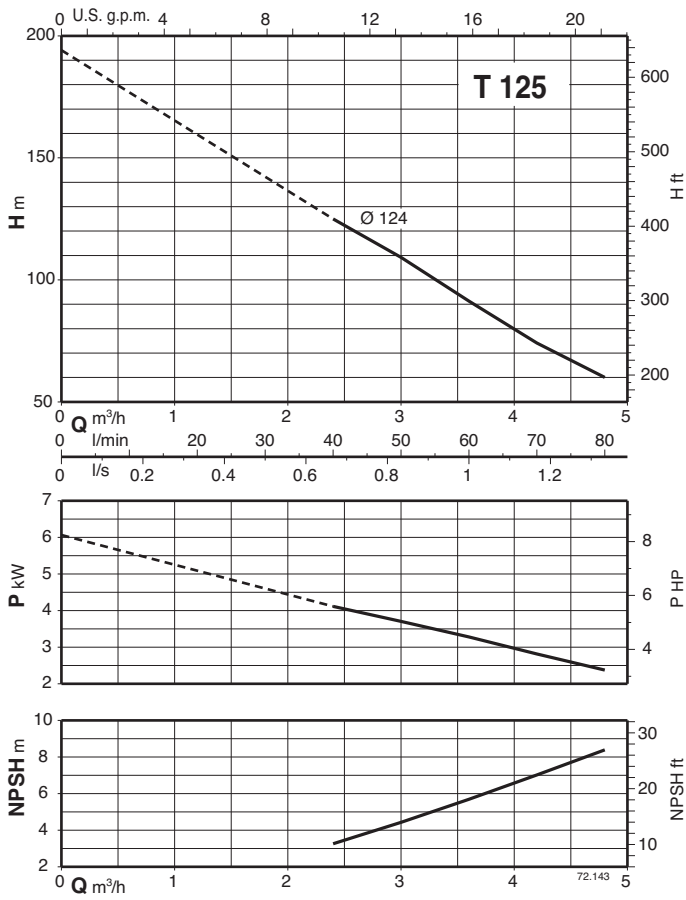

Features

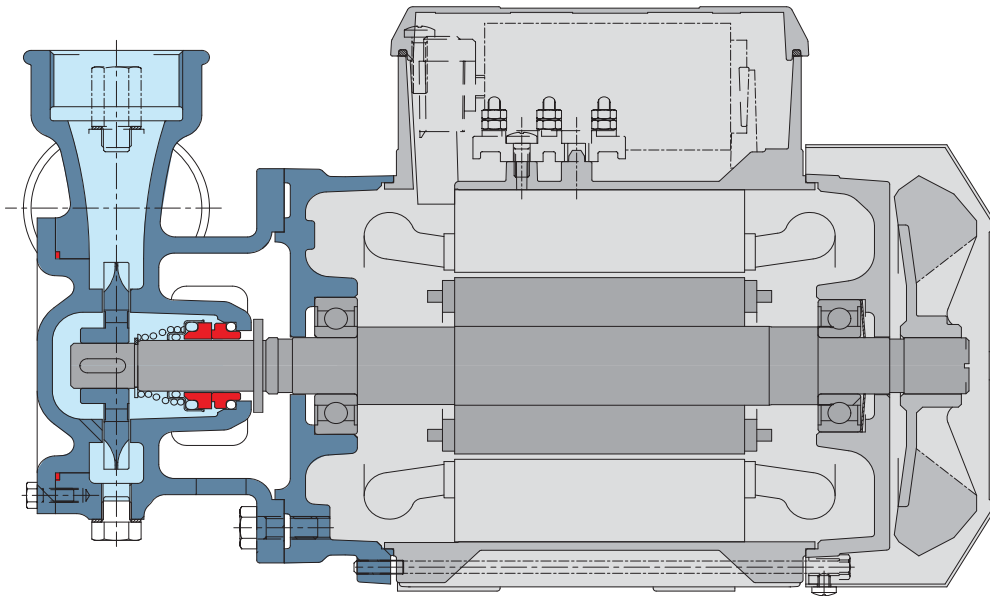

Range

The high number of pumps in the range can meet the widest range of services required by the user.

Flexible

The option to choose between cast iron and bronze materials for the hydraulic parts in contact with the pumped liquid allows T-TP series pumps to be selected for use with different types of liquids.

Reliable

The bearing and shaft are designed to ensure the reduction of the stress, providing high reliability under all operating conditions.

Optimized hydraulics

The pump hydraulics are designed to ensure high performance and consistency of performance.