

Stainless Steel Basic Pedestal



Self Priming Centrifugal Pump

Model 16A64-B

Size 6" x 6"

PUMP SPECIFICATIONS

Size: 6" x 6" (152 mm x 152 mm) NPT - Female.

Casing: Stainless Steel CD4MCu.

Maximum Operating Pressure 81 psi (558 kPa).*

Semi-Open Type, Two Vane Impeller: Stainless Steel CD4MCu.

Handles 2 1/2" (63,5 mm) Diameter Spherical Solids.

Impeller Shaft: Stainless Steel 17-4PH.

Shaft Sleeve: Stainless Steel 17-4PH.

Replaceable Wear Plate: Stainless Steel CD4MCu.

Removable Cover Plate: Stainless Steel CD4MCu; 64 lbs. (29 kg).

Pedestal: Gray Iron 30.

Seal Plate: Stainless Steel CD4MCu.

Flap Valve: Fluorocarbon Elastomers (DuPont Viton® or Equivalent) and Stainless Steel 316.

Radial Bearing: Open Single Row Ball.

Thrust Bearing: Open Double Row Ball.

Bearing Lubrication: SAE 30 Non-Detergent Oil.

Flanges: Stainless Steel 316.

Gaskets: PTFE and Fluorocarbon (DuPont Teflon® and Viton® or Equivalents).

Hardware: Stainless Steel 316.

Optional Equipment: Consult Factory.

**Consult Factory for Applications Exceeding Maximum Pressure and/or Temperature Indicated.*

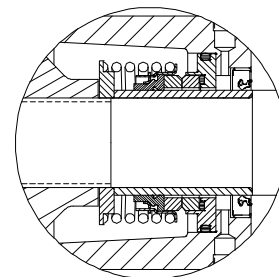
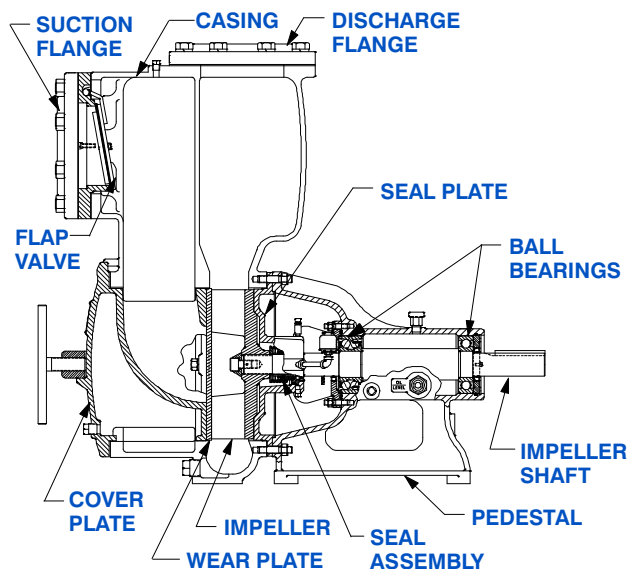

SEAL DETAIL

Mechanical, Oil-Lubricated, Double Floating, Self-Aligning. Tungsten Titanium Carbide Rotating and Stationary Faces. Stainless Steel 316 Stationary Seat. Fluorocarbon Elastomers (DuPont Viton® or Equivalent). Stainless Steel 18-8 Cage and Spring. Maximum Temperature of Liquid Pumped, 160°F (71°C).*



THE GORMAN-RUPP COMPANY • MANSFIELD, OHIO

GORMAN-RUPP OF CANADA LIMITED • ST. THOMAS, ONTARIO, CANADA

www.grpumps.com

Specifications Subject to Change Without Notice

Printed in U.S.A.

Specification Data

SECTION 55, PAGE 810

APPROXIMATE DIMENSIONS and WEIGHTS

NET WEIGHT: 735 LBS. (333 KG.)
SHIPPING WEIGHT: 770 LBS. (349 KG.)
EXPORT CRATE SIZE: 29.8 CU. FT. (0,84 CU. M.)

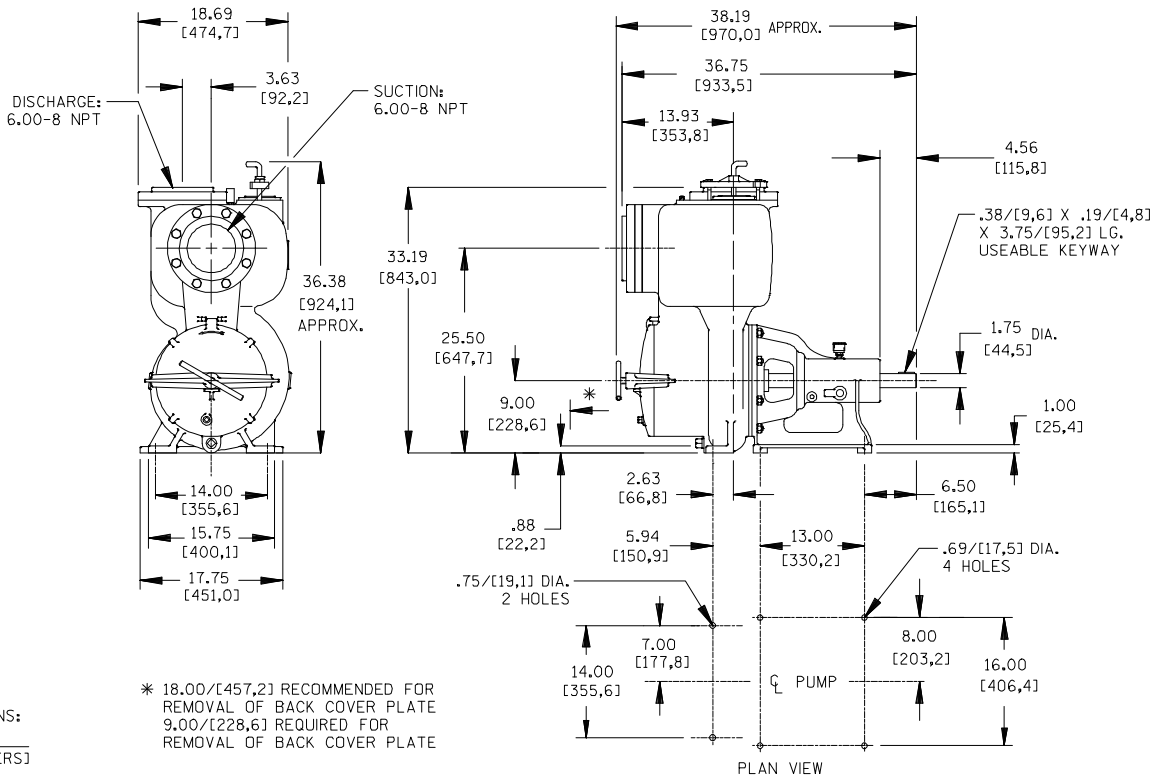

DIMENSIONS:
INCHES
[MILLIMETERS]

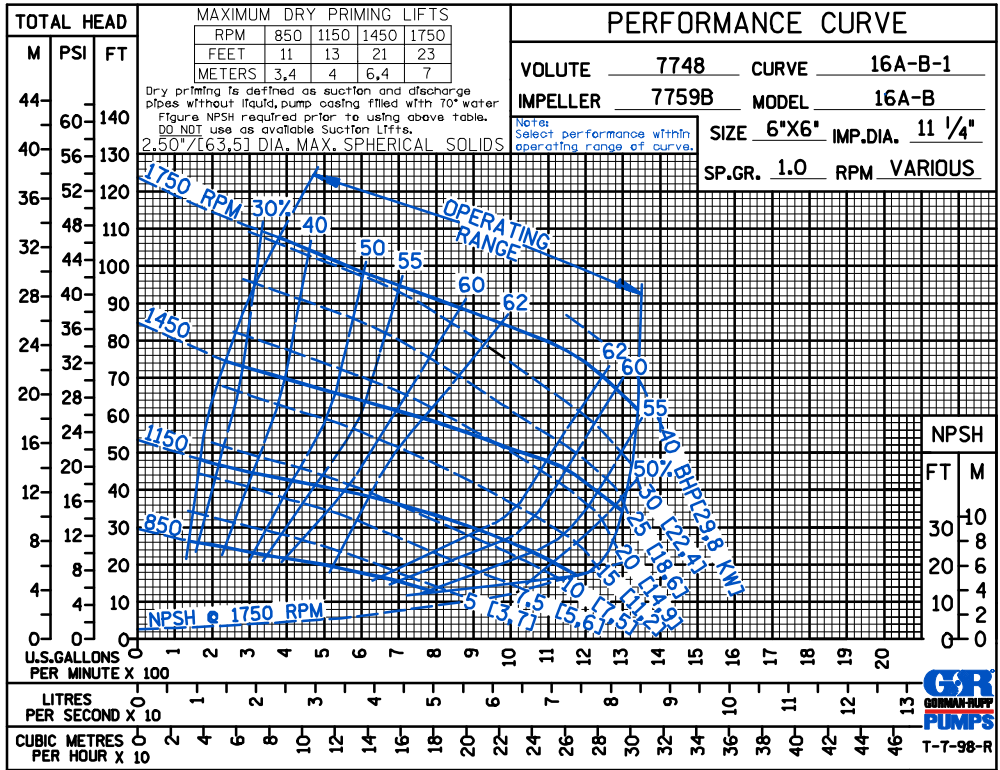

THE GORMAN-RUPP COMPANY • MANSFIELD, OHIO

GORMAN-RUPP OF CANADA LIMITED • ST. THOMAS, ONTARIO, CANADA

Specifications Subject to Change Without Notice

Printed in U.S.A.

AC DE

TRIMMED
IMPELLER

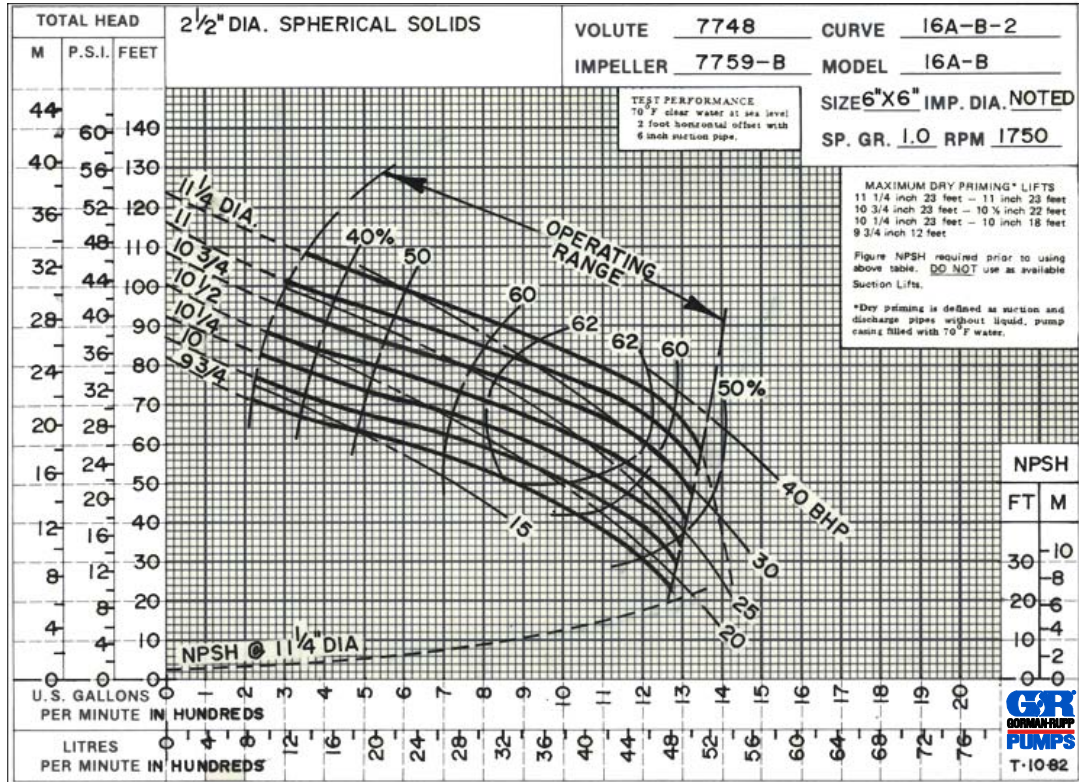

60 HERTZ
PERFORMANCE
BASED ON
WATER

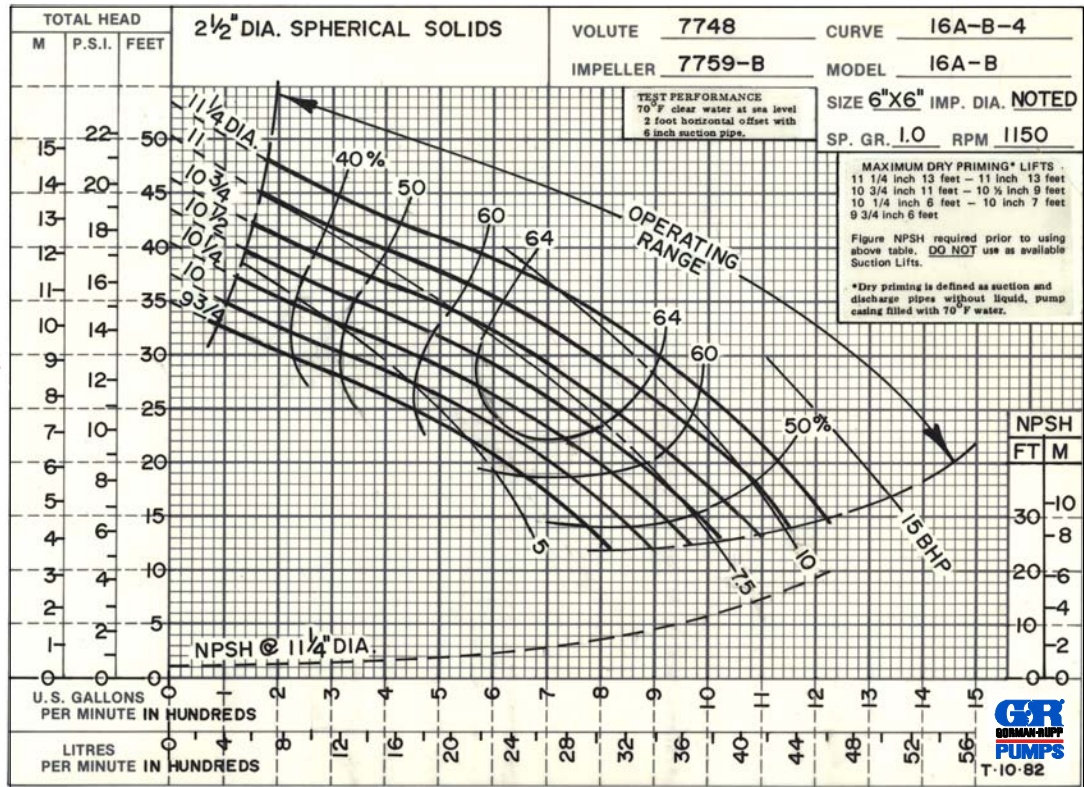

THE GORMAN-RUPP COMPANY • MANSFIELD, OHIO

GORMAN-RUPP OF CANADA LIMITED • ST. THOMAS, ONTARIO, CANADA

Specifications Subject to Change Without Notice

Printed in U.S.A.

A C D E

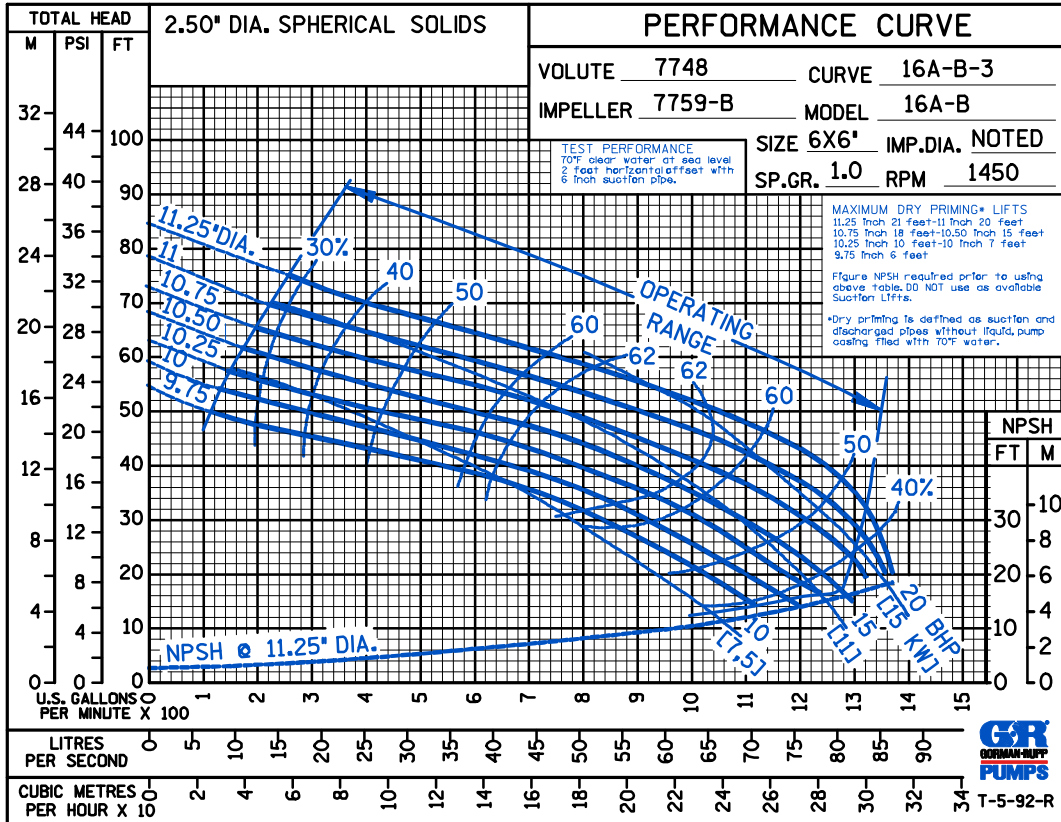

THE GORMAN-RUPP COMPANY • MANSFIELD, OHIO

GORMAN-RUPP OF CANADA LIMITED • ST. THOMAS, ONTARIO, CANADA

Specifications Subject to Change Without Notice

Printed in U.S.A.