

ACE

# Self Priming Centrifugal Pump

## Model 83A2-B

### Size 3" x 3"



#### PUMP SPECIFICATIONS

**Size:** 3" x 3" (76 mm x 76 mm) NPT - Female.

**Casing:** Gray Iron 30.

Maximum Operating Pressure 87 psi (600 kPa).\*

**Semi-Open Type, Four Vane Impeller:** Gray Iron 30.

Handles 3/4" (19,1 mm) Diameter Spherical Solids.

**Impeller Shaft:** Carbon Steel 1045.

**Replaceable Wear Plate:** Carbon Steel 1026.

**Pedestal:** Gray Iron 30.

**Seal Plate:** Gray Iron 30.

**Seal Liner:** Copper Alloy C26000.

**Flap Valve:** Gray Iron 30 and Buna-N <sup>w</sup>/Nylon Reinforcement.

**Radial and Thrust Bearings:** Open Single Row Ball.

**Bearing Lubrication:** SAE 30 Non-Detergent Oil.

**Suction Flange:** Gray Iron 25.

**Gaskets:** Vegetable Fiber.

**Hardware:** Standard Plated Steel.

**Discharge Service Tee:** Gray Iron 30.

**Oil Level Sight Gage.**

**Optional Equipment:** Strainer.

Consult Factory for Additional Options.

*\*Consult Factory for Applications Exceeding  
Maximum Pressure and/or Temperature Indicated.*

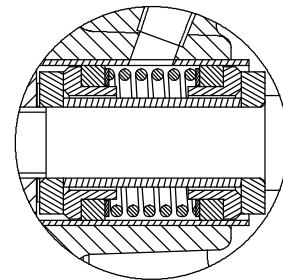
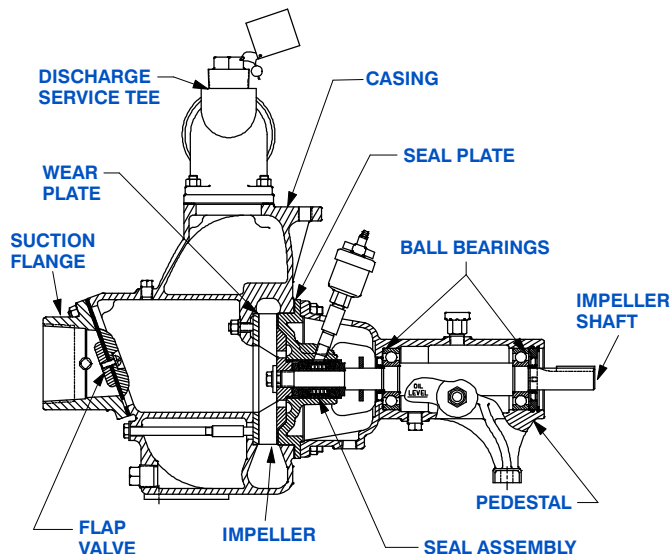

#### SEAL DETAIL

Double, Grease-Lubricated with Spring-Loaded Grease Cup. Sintered Bronze Stationary Seal Seats. Steel Rotating Faces. Neoprene Packing Rings. Maximum Temperature of Liquid Pumped, 110°F (43°C). Maximum Suction Pressure 10 psi (69 kPa).\*



THE GORMAN-RUPP COMPANY • MANSFIELD, OHIO

GORMAN-RUPP OF CANADA LIMITED • ST. THOMAS, ONTARIO, CANADA

www.grpumps.com

Specifications Subject to Change Without Notice

Printed in U.S.A.

**Specification Data**

**SECTION 50, PAGE 1450**

APPROXIMATE  
DIMENSIONS and WEIGHTS

**NET WEIGHT: 115 LBS. (52,2 KG.)**  
**SHIPPING WEIGHT: 125 LBS. (56,7 KG.)**  
**EXPORT CRATE: 8.5 CU. FT. (0,24 CU. M.)**

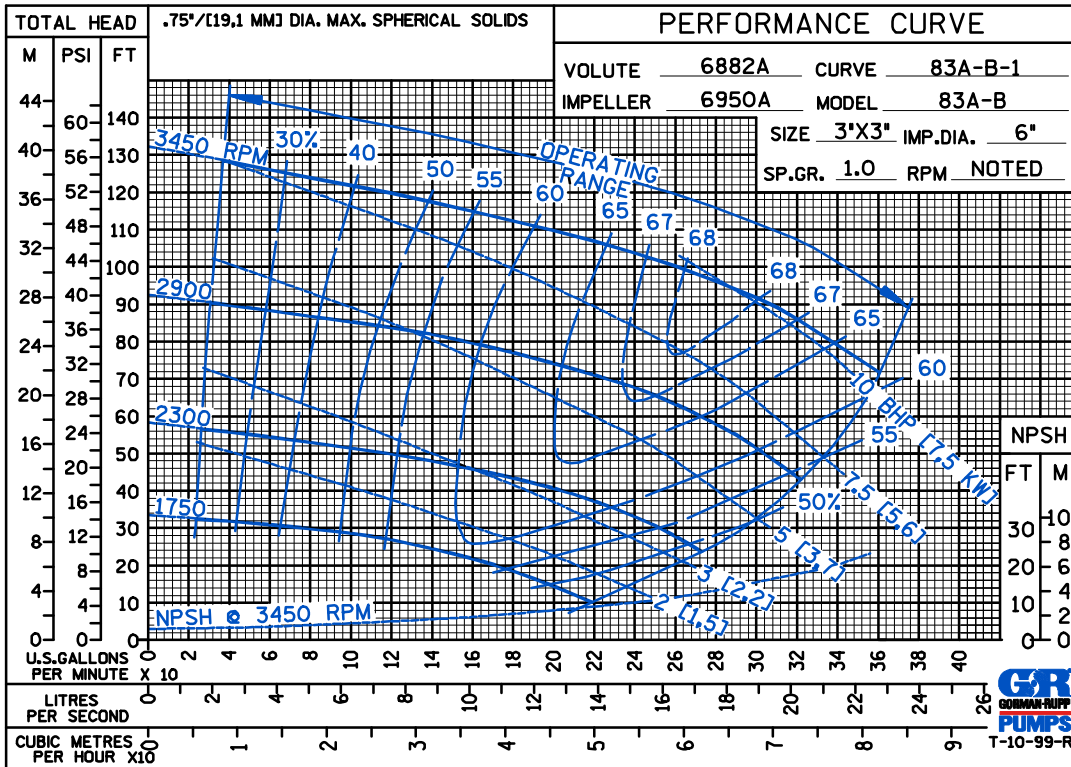
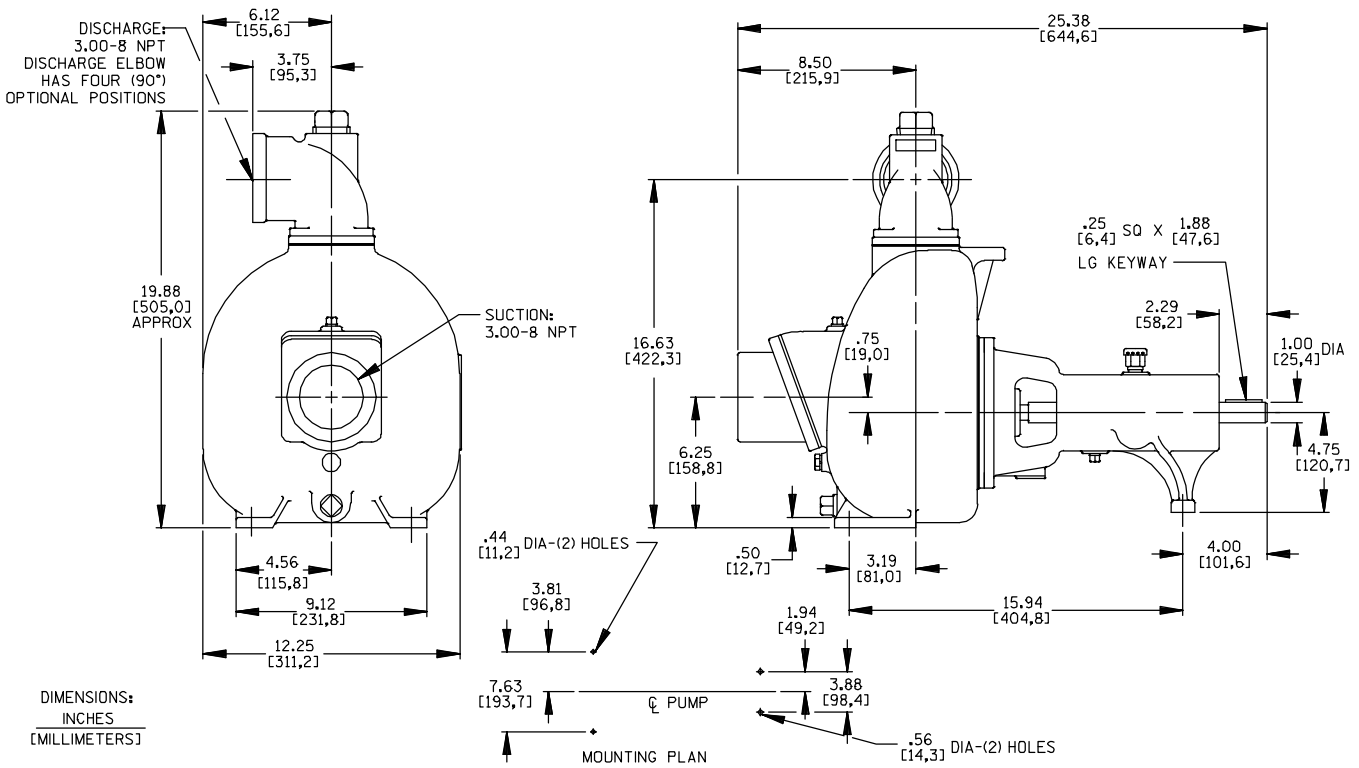

**THE GORMAN-RUPP COMPANY • MANSFIELD, OHIO**

GORMAN-RUPP OF CANADA LIMITED • ST. THOMAS, ONTARIO, CANADA

Specifications Subject to Change Without Notice

Printed in U.S.A.

A B C D E

60 HERTZ  
PERFORMANCE  
BASED ON  
WATER

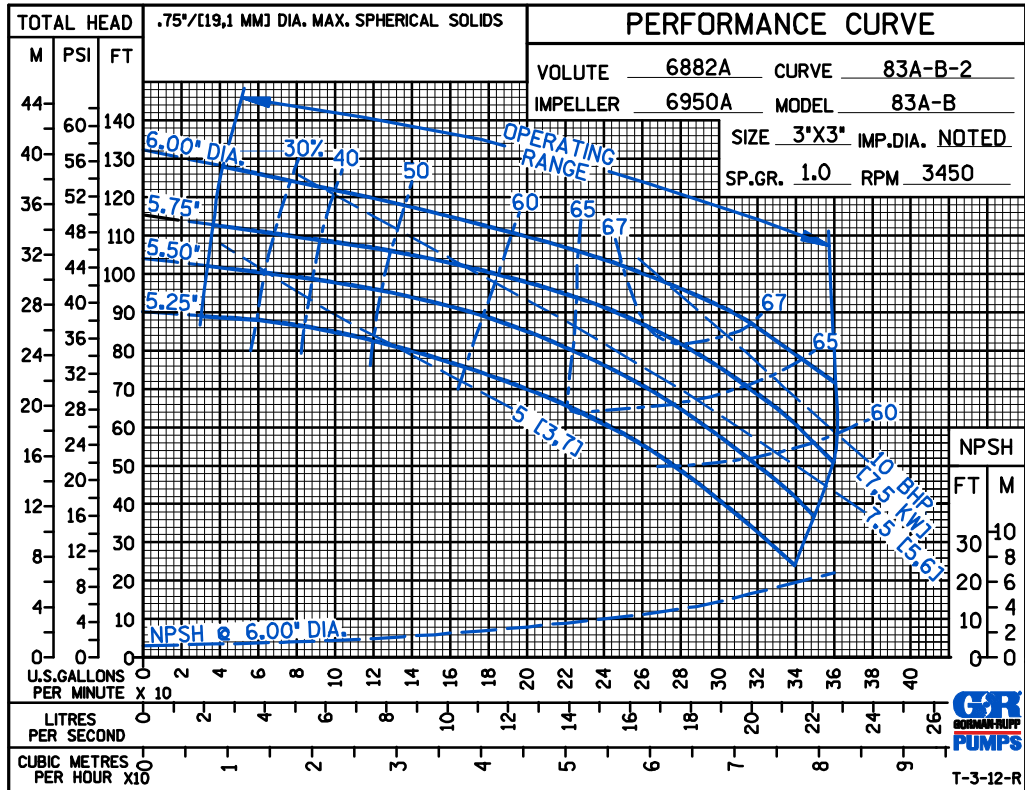

PERFORMANCE  
BASED ON  
PETROLEUM

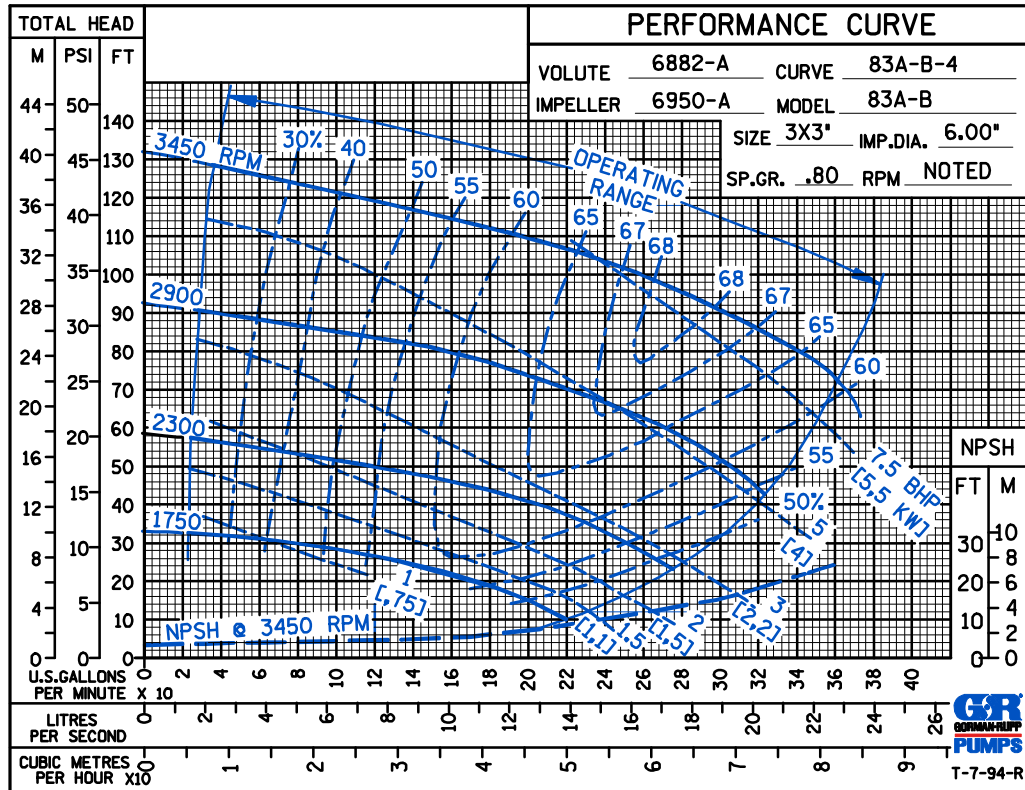

THE GORMAN-RUPP COMPANY • MANSFIELD, OHIO

GORMAN-RUPP OF CANADA LIMITED • ST. THOMAS, ONTARIO, CANADA

Specifications Subject to Change Without Notice

Printed in U.S.A.

A B C D E

50 HERTZ  
PERFORMANCE  
BASED ON  
WATER

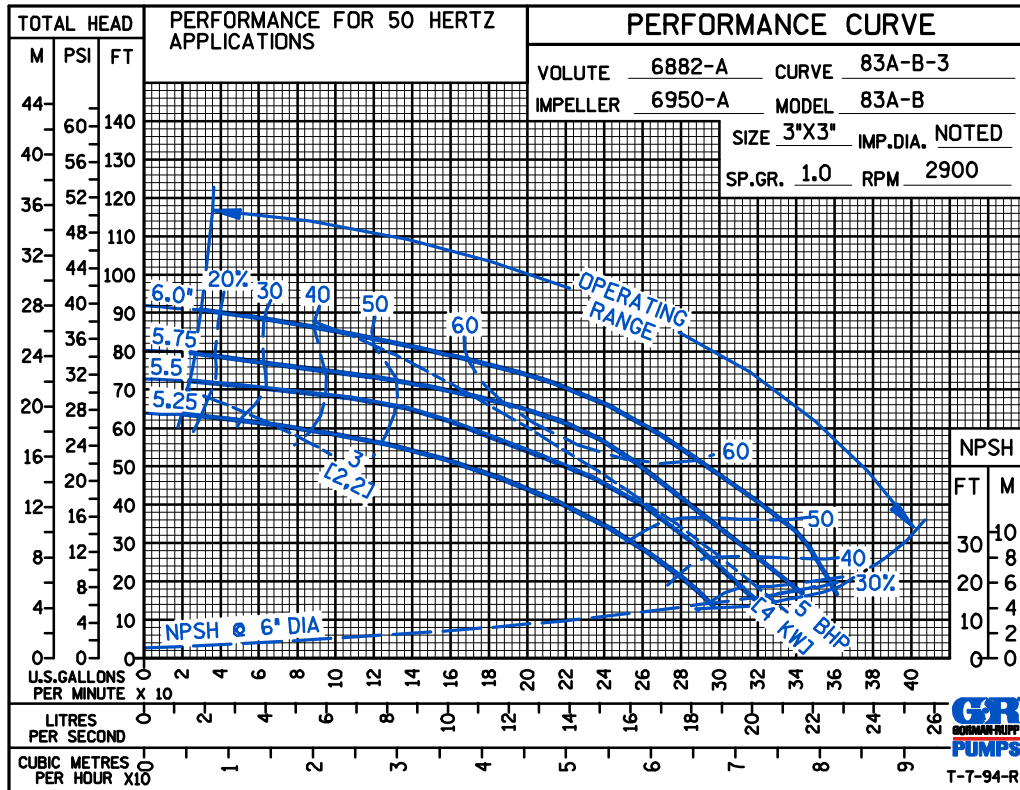

THE GORMAN-RUPP COMPANY • MANSFIELD, OHIO

GORMAN-RUPP OF CANADA LIMITED • ST. THOMAS, ONTARIO, CANADA

Specifications Subject to Change Without Notice

Printed in U.S.A.