

c

Self Priming Centrifugal Pump

**Super
T SERIES**
VARIOUS PATENTS APPLY

Model T4B60S-B

Size 4" x 4"



PUMP SPECIFICATIONS

Size: 4" x 4" (101 mm x 101 mm) NPT - Female.

Casing: Gray Iron 30.

Maximum Operating Pressure 97 psi (669 kPa).*

Semi-Open Type, Five Vane Impeller: Ductile Iron 65-45-12.

Handles 1 1/2" (38,1 mm) Diameter Spherical Solids.

Impeller Shaft: Alloy Steel 4150.

Shaft Sleeve: Alloy Steel 4130.

Replaceable Wear Plate: Gray Iron 30.

Removable Adjustable Cover Plate: Gray Iron 30; 42 lbs. (19 kg).

Flap Valve: Neoprene w/Nylon and Steel Reinforcing.

Seal Plate: Gray Iron 30.

Bearing Housing: Gray Iron 30.

Radial Bearing: Open Single Row Ball.

Thrust Bearing: Open Double Row Ball.

Bearing and Seal Cavity Lubrication: SAE 30 Non-Detergent Oil.

Flanges: 125# Gray Iron 30.

Gaskets: Buna-N, Compressed Synthetic Fibers, Vegetable Fiber, PTFE, Cork, and Rubber.

O-Rings: Buna-N.

Hardware: Standard Plated Steel.

Brass Pressure Relief Valve.

Bearing and Seal Cavity Oil Level Sight Gauges.

Optional Equipment: Stainless Steel 316 Pressure Relief

Valve. Automatic Air Release Valve. Metal Bellows Seal.

120V/240V Casing Heater. High Pump Temperature Shutdown

Kit. G-R Hard Iron Casing.

Gray Iron 30 Suction and Discharge Spool Flanges:

4" ASA (**Specify Model T4B60S-B /F**).

100 mm DIN 2527 (PN 16) (**Specify Model T4B60S-B /FM**).

**Consult Factory for Applications Exceeding Maximum Pressure and/or Temperature Indicated.*



Shown with Optional Suction & Discharge Spool Flanges (Available in ASA or DIN Standard Sizes).

SEAL SPECIFICATIONS

Cartridge Type, Mechanical, Oil-Lubricated, Double Floating, Self-Aligning. Silicon Carbide Rotating and Stationary Faces. Stainless Steel 316 Stationary Seat. Fluorocarbon Elastomers (DuPont Viton® or Equivalent). Stainless Steel 18-8 Cage and Spring. Maximum Temperature of Liquid Pumped, 160°F (71°C).*

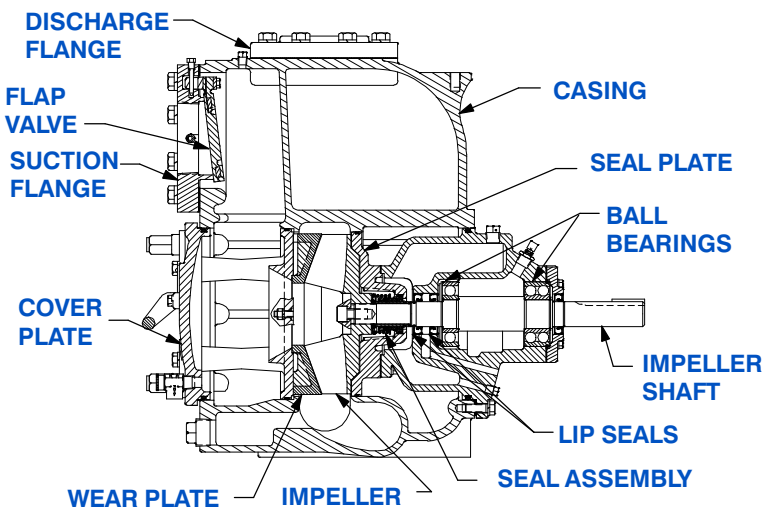

SEAL DETAIL

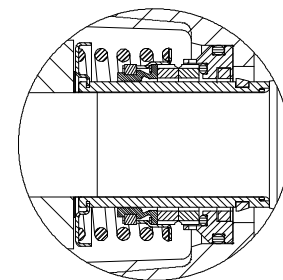

GR
GORMAN-RUPP
PUMPS

THE GORMAN-RUPP COMPANY • MANSFIELD, OHIO

GORMAN-RUPP OF CANADA LIMITED • ST. THOMAS, ONTARIO, CANADA

www.grpumps.com

Specifications Subject to Change Without Notice

Printed in U.S.A.

Specification Data

SECTION 55, PAGE 2160

APPROXIMATE DIMENSIONS and WEIGHTS

NET WEIGHT: 575 LBS. (261 KG.)*
SHIPPING WEIGHT: 614 LBS. (279 KG.)*
EXPORT CRATE: 22.7 CU. FT. (0,64 CU. M.)
***ADD 15 LBS. (6,8 KG.) W/EACH SPOOL FLANGE**

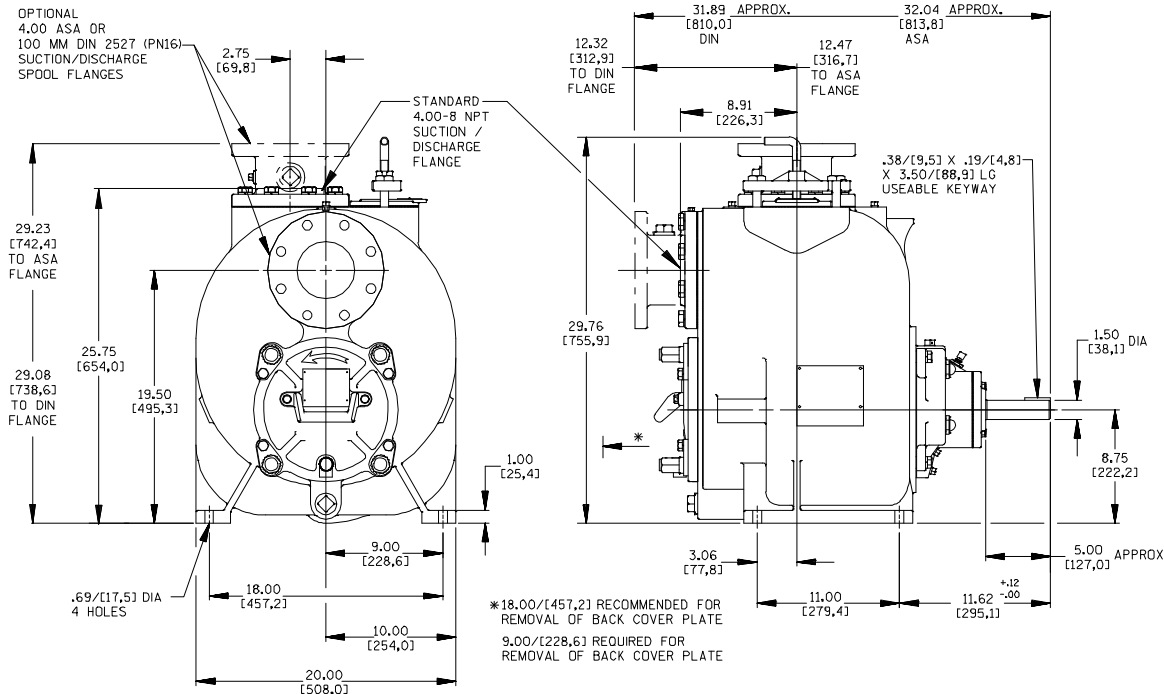

NOTE: OPTIONAL ASA OR DIN STANDARD SUCITON & DISCHARGE SPOOL FLANGES AVAILABLE.

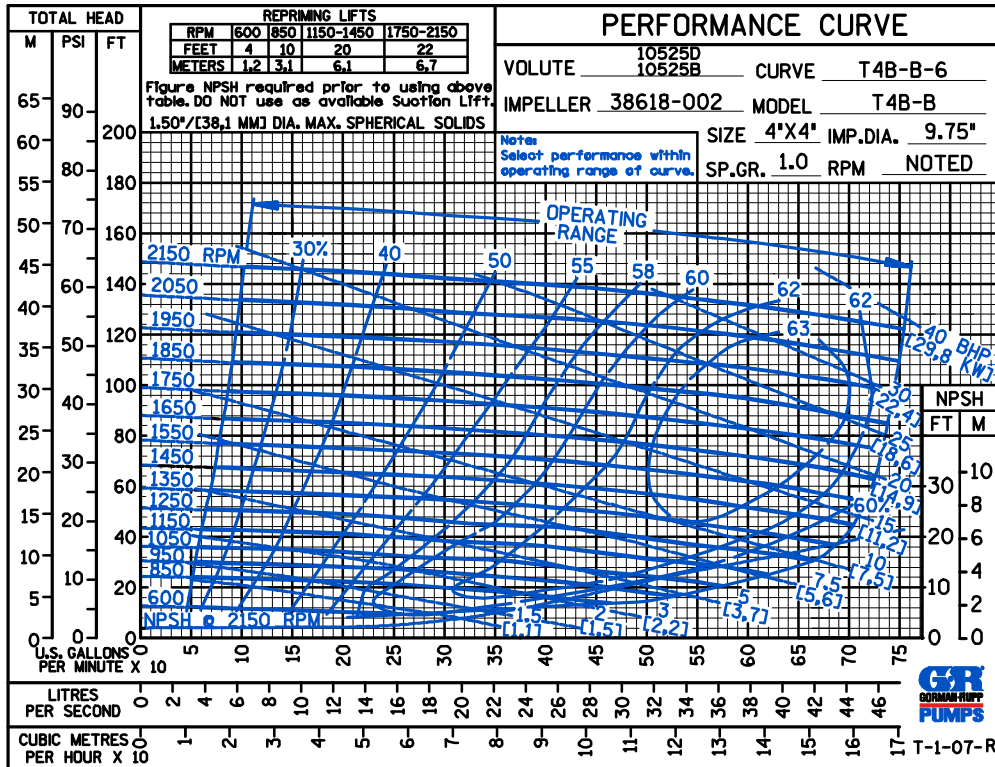

THE GORMAN-RUPP COMPANY • MANSFIELD, OHIO

GORMAN-RUPP OF CANADA LIMITED • ST. THOMAS, ONTARIO, CANADA

Specifications Subject to Change Without Notice

Printed in U.S.A.



THE GORMAN-RUPP COMPANY • MANSFIELD, OHIO

GORMAN-RUPP OF CANADA LIMITED • ST. THOMAS, ONTARIO, CANADA

www.grpumps.com

Specifications Subject to Change Without Notice

Printed in U.S.A.

© Copyright by the Gorman-Rupp Company 2008

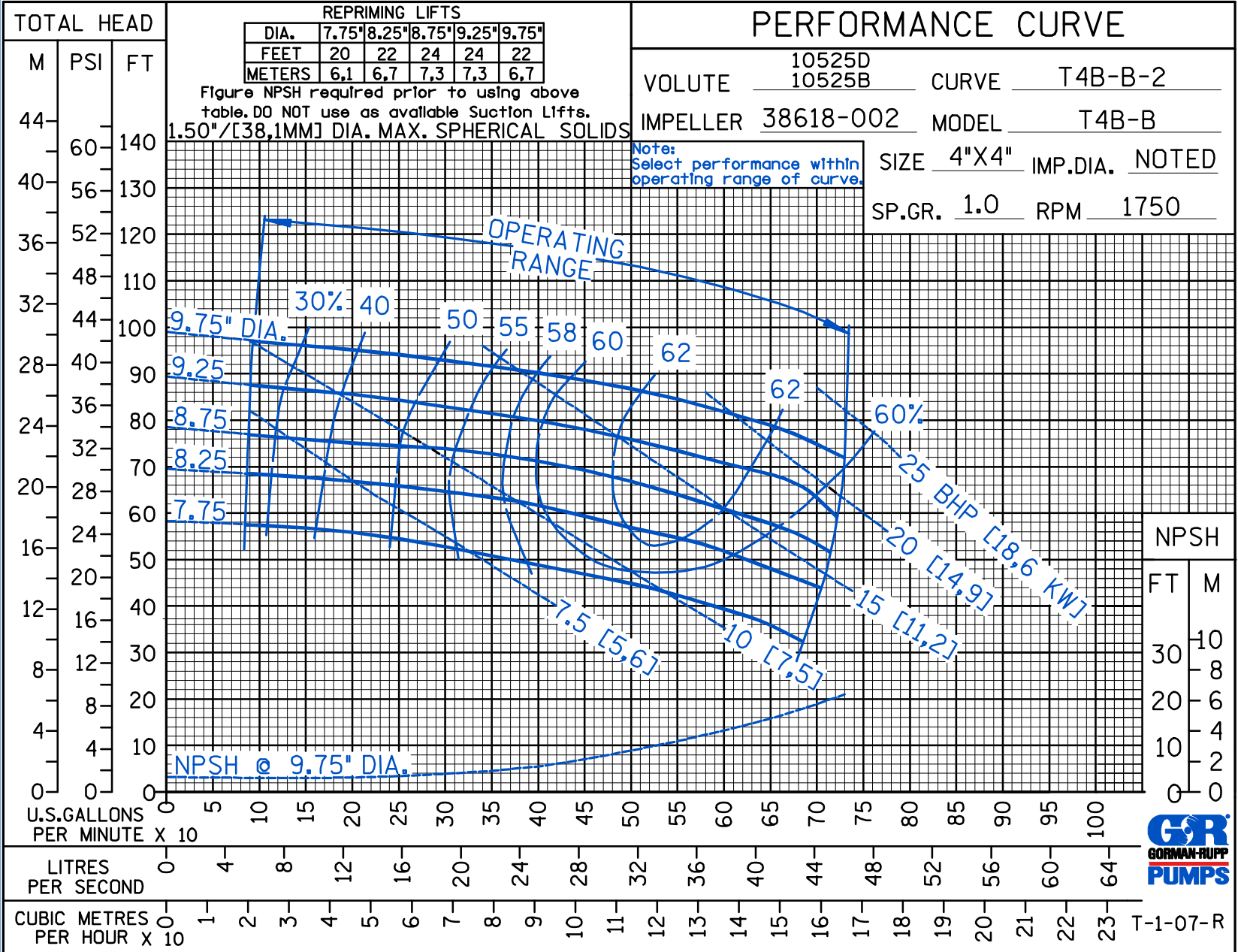

CDSW

Curve Data

Sec. 55

PAGE 2185.1
JULY 2008



T-1-07-R



THE GORMAN-RUPP COMPANY • MANSFIELD, OHIO
 GORMAN-RUPP OF CANADA LIMITED • ST. THOMAS, ONTARIO, CANADA
 www.grpumps.com
 Specifications Subject to Change Without Notice

© Copyright by the Gorman-Rupp Company 2008

Printed in U.S.A.

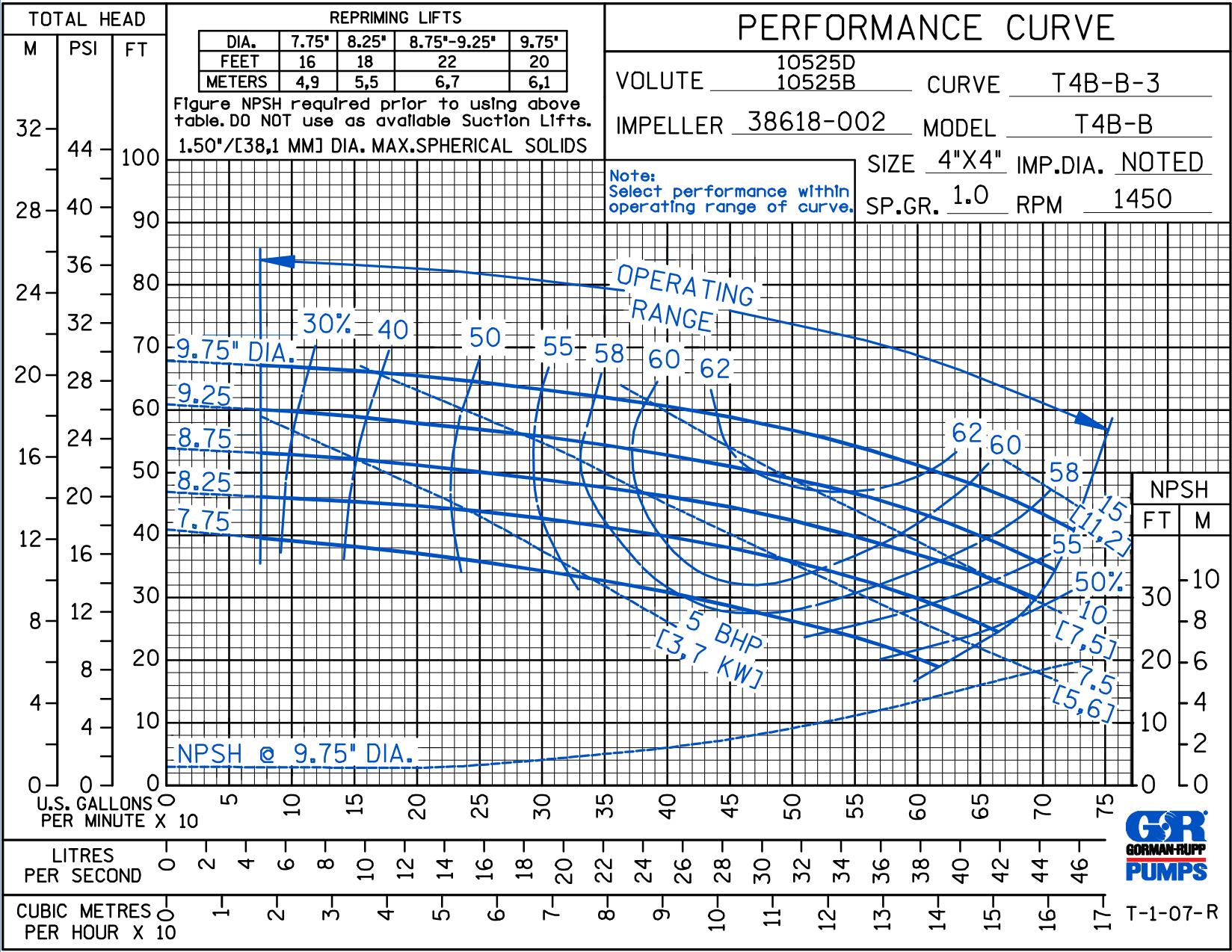

CDSW

Curve Data

Sec. 55

PAGE 2185.2
JULY 2008



THE GORMAN-RUPP COMPANY • MANSFIELD, OHIO
 GORMAN-RUPP OF CANADA LIMITED • ST. THOMAS, ONTARIO, CANADA
 www.grpumps.com

Specifications Subject to Change Without Notice

Printed in U.S.A.

© Copyright by the Gorman-Rupp Company 2008

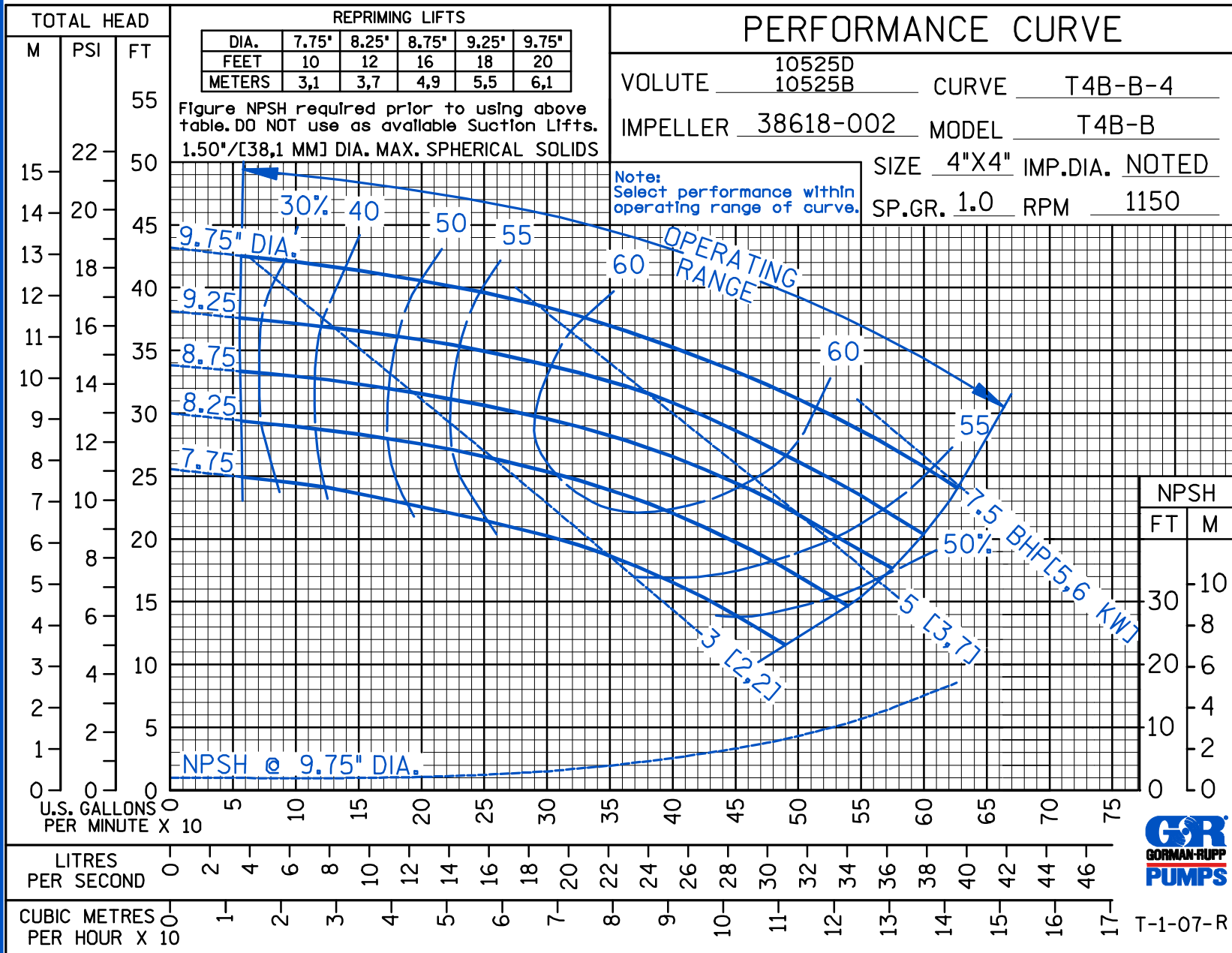

CDSW

Curve Data

Sec. 55

PAGE 2185.3
 JULY 2008





THE GORMAN-RUPP COMPANY • MANSFIELD, OHIO
 GORMAN-RUPP OF CANADA LIMITED • ST. THOMAS, ONTARIO, CANADA
 www.grpumps.com

© Copyright by the Gorman-Rupp Company 2008

Specifications Subject to Change Without Notice

Printed in U.S.A.

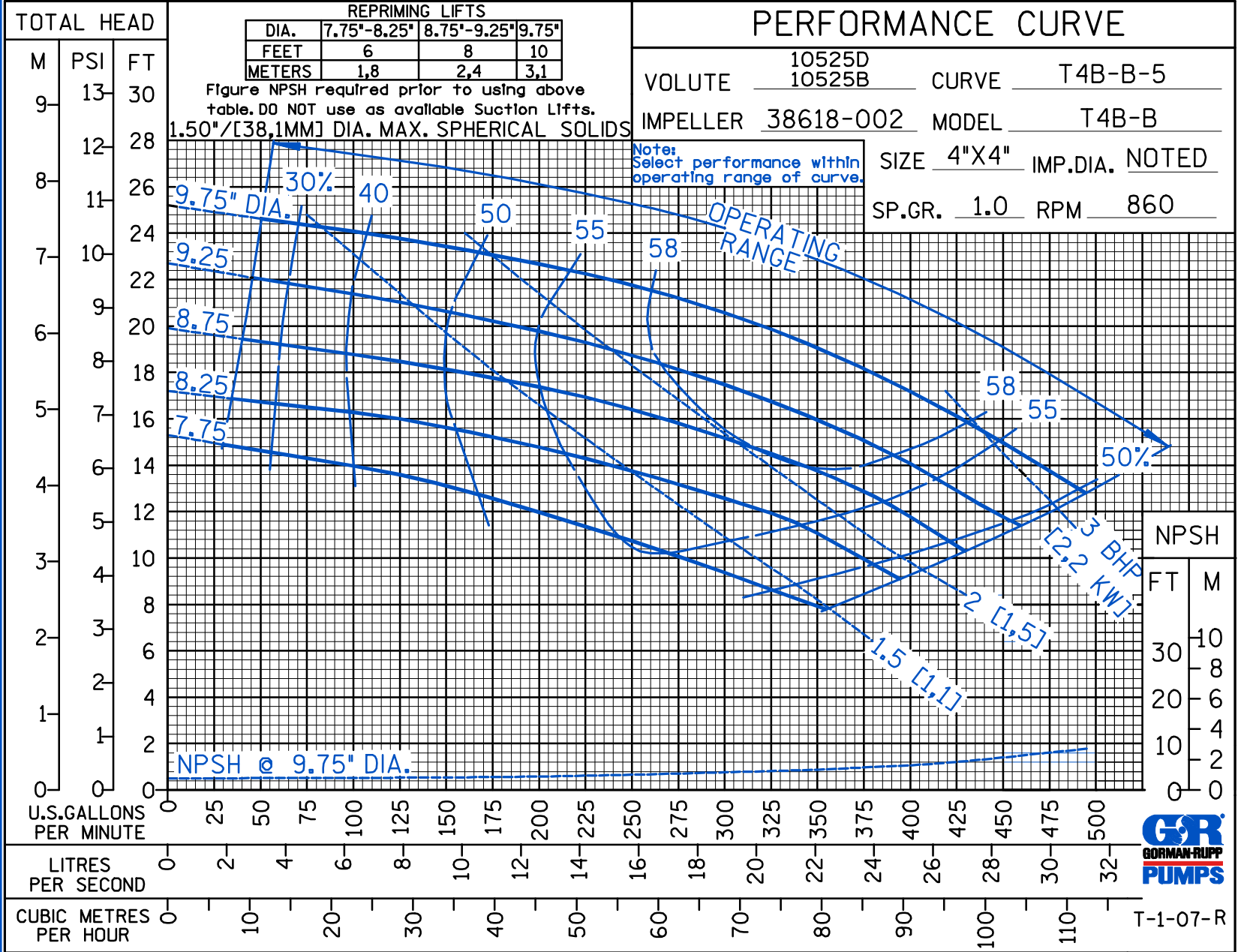

CDSW

Curve Data

Sec. 55

PAGE 2185.4
JULY 2008



THE GORMAN-RUPP COMPANY • MANSFIELD, OHIO

GORMAN-RUPP OF CANADA LIMITED • ST. THOMAS, ONTARIO, CANADA

www.grpumps.com

Specifications Subject to Change Without Notice

Printed in U.S.A.

© Copyright by the Gorman-Rupp Company 2008

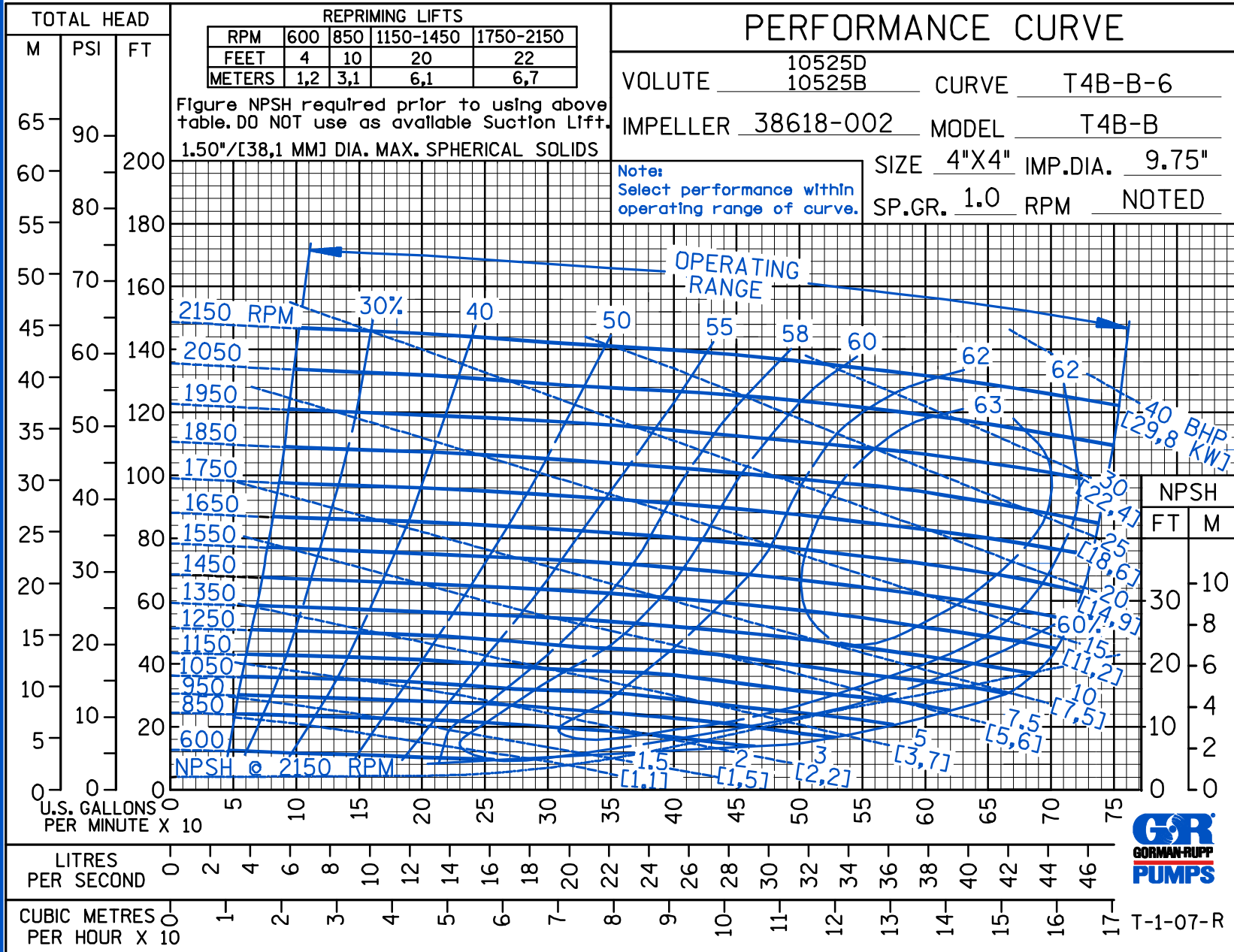

CDSW

Curve Data

Sec. 55

PAGE 2185.5
JULY 2008



THE GORMAN-RUPP COMPANY • MANSFIELD, OHIO
 GORMAN-RUPP OF CANADA LIMITED • ST. THOMAS, ONTARIO, CANADA
 www.grpumps.com

© Copyright by the Gorman-Rupp Company 2008

Specifications Subject to Change Without Notice

Printed in U.S.A.

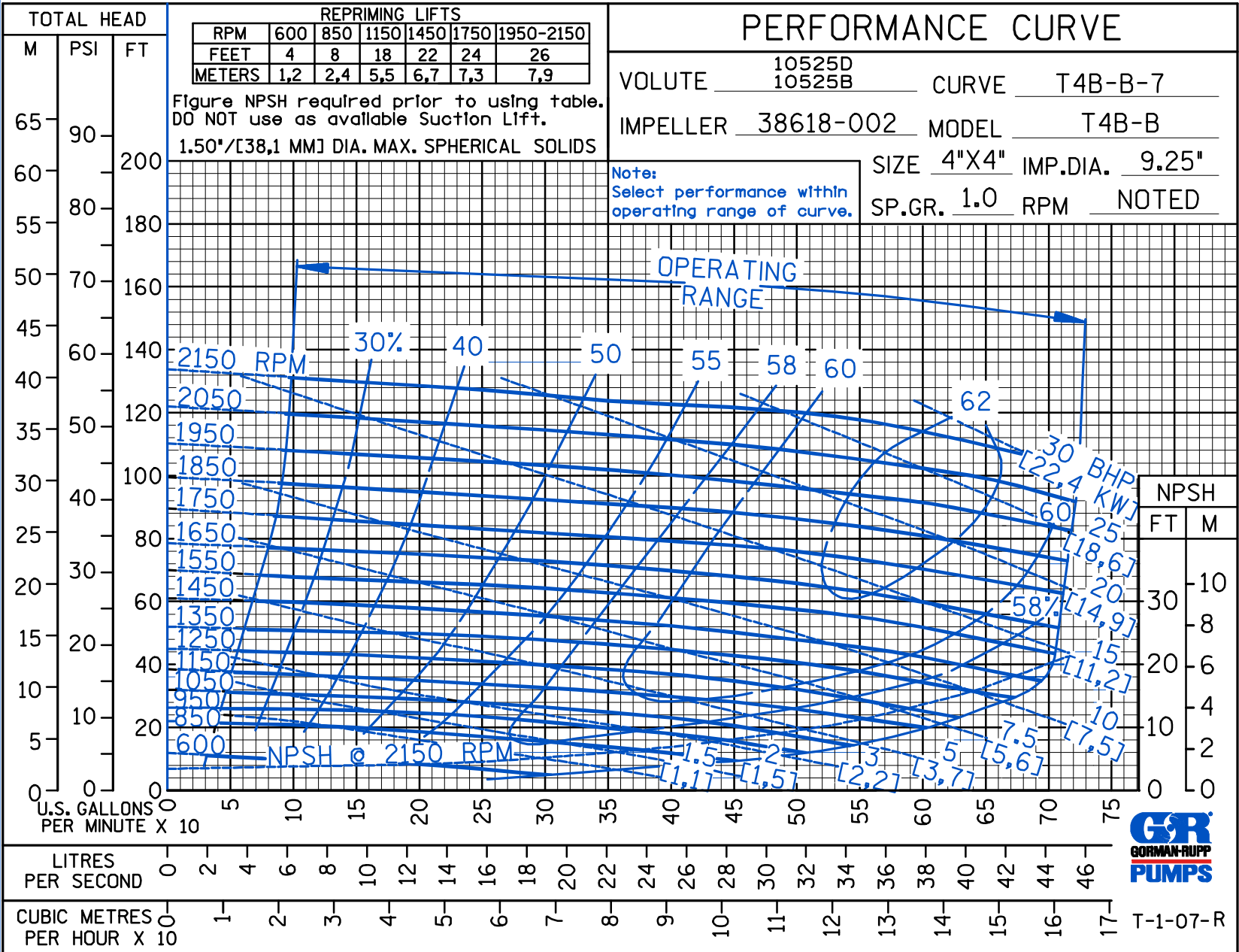

CDSW

Curve Data

Sec. 55

PAGE 2185.6
 JULY 2008



THE GORMAN-RUPP COMPANY • MANSFIELD, OHIO

GORMAN-RUPP OF CANADA LIMITED • ST. THOMAS, ONTARIO, CANADA

www.grpumps.com

Specifications Subject to Change Without Notice

Printed in U.S.A.

© Copyright by the Gorman-Rupp Company 2008

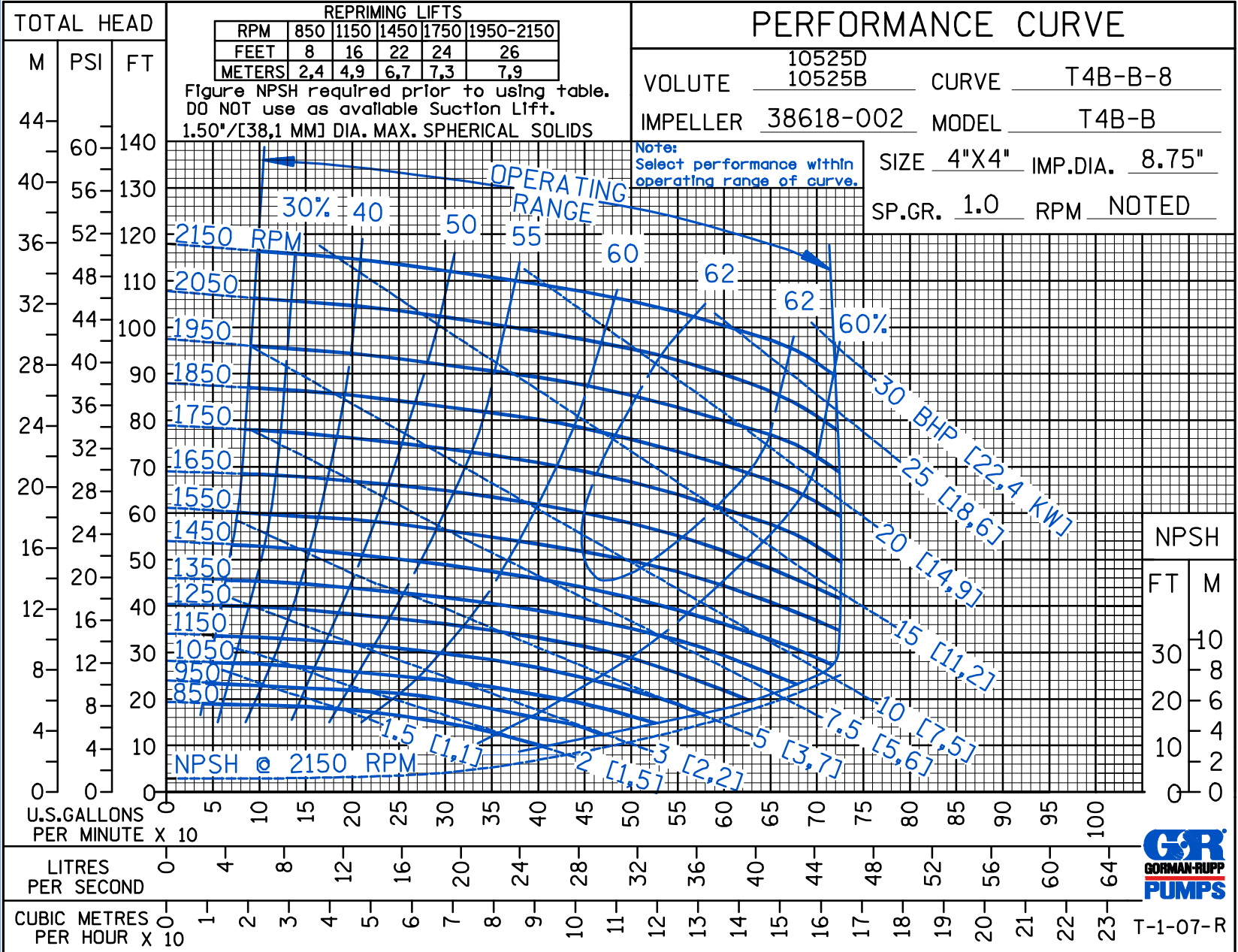

CDSW

Curve Data

Sec. 55

PAGE 2185.7
JULY 2008



THE GORMAN-RUPP COMPANY • MANSFIELD, OHIO
 GORMAN-RUPP OF CANADA LIMITED • ST. THOMAS, ONTARIO, CANADA
 www.grpumps.com

© Copyright by the Gorman-Rupp Company 2008

Printed in U.S.A.

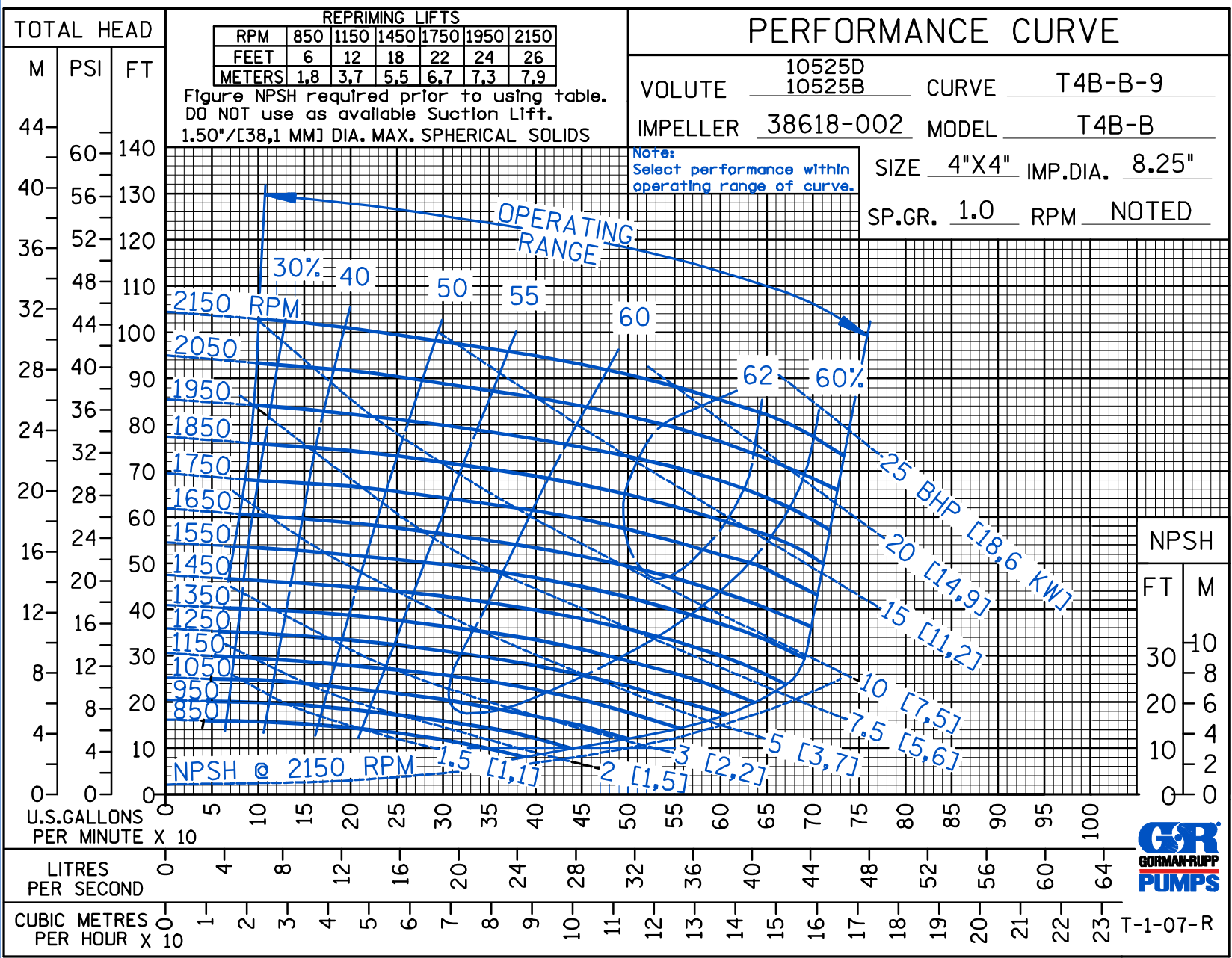

CDSW

Curve Data

Sec. 55

PAGE 2185.8
JULY 2008



THE GORMAN-RUPP COMPANY • MANSFIELD, OHIO

GORMAN-RUPP OF CANADA LIMITED • ST. THOMAS, ONTARIO, CANADA

www.grpmumps.com

Specifications Subject to Change Without Notice

Printed in U.S.A.

© Copyright by the Gorman-Rupp Company 2008

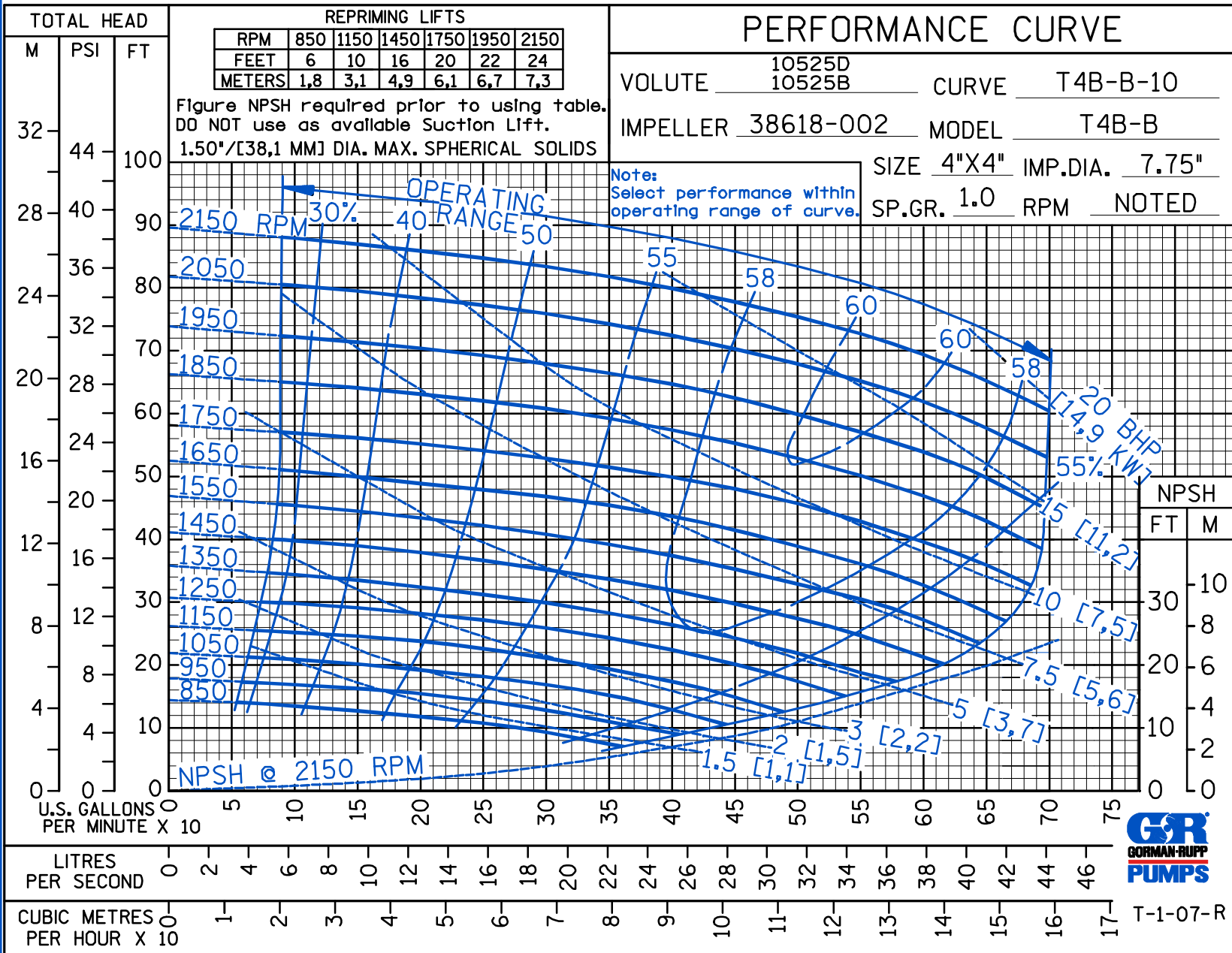

CDSW

Curve Data

Sec. 55

PAGE 2185.9
JULY 2008



THE GORMAN-RUPP COMPANY • MANSFIELD, OHIO
 GORMAN-RUPP OF CANADA LIMITED • ST. THOMAS, ONTARIO, CANADA
 www.grpumps.com

Specifications Subject to Change Without Notice

Printed in U.S.A.

© Copyright by the Gorman-Rupp Company 2008

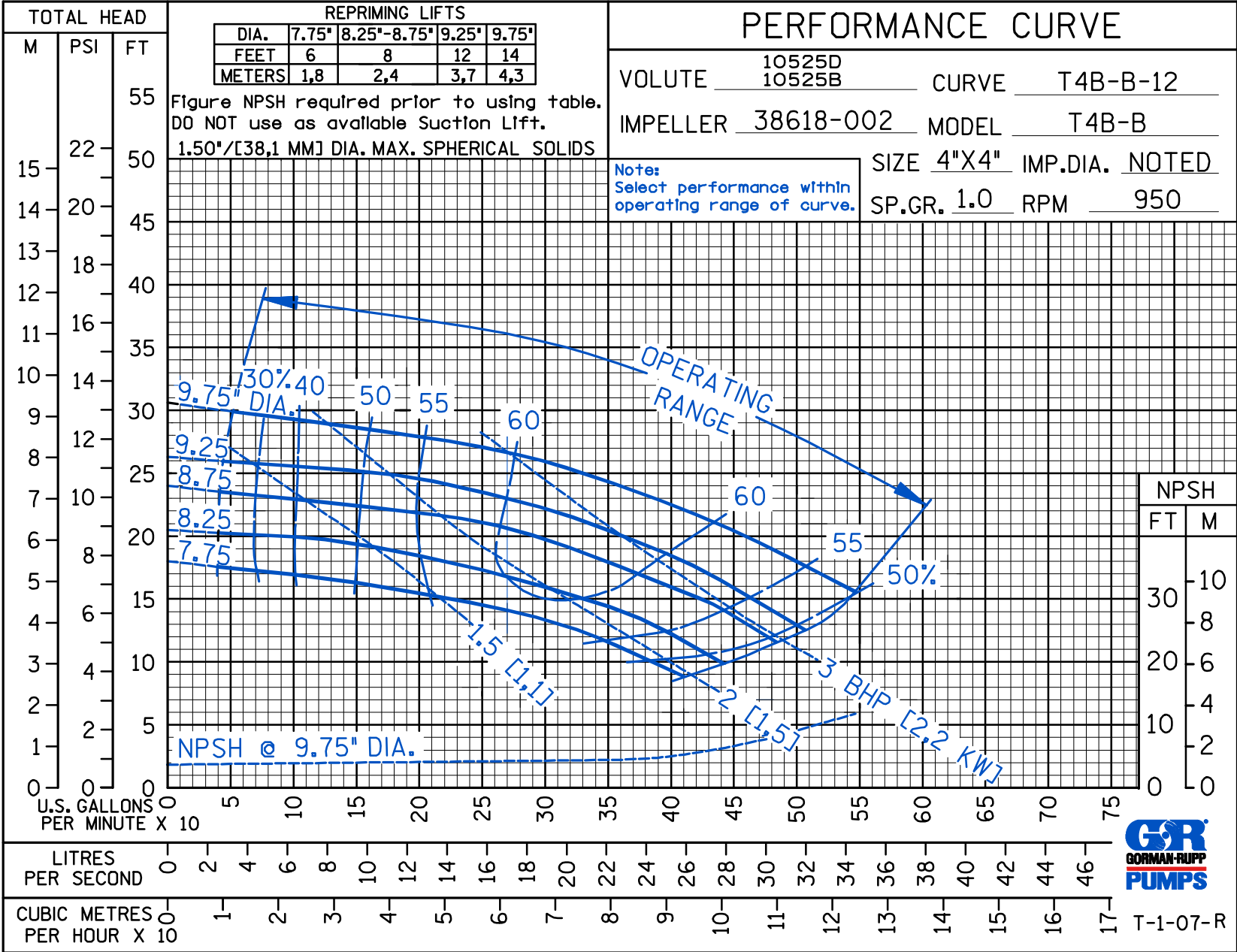

CDSW

Curve Data

Sec. 55

PAGE 2185.10
 JULY 2008



T-1-07-R

D S W

PERFORMANCE CURVE

VOLUTE 10525D
10525B CURVE T4B-B-13
IMPELLER 38618-002 MODEL T4B-B
SIZE 4"X4" IMP.DIA. 9.75"
SP.GR. 1.0 RPM NOTED

1.50"/[38,1 MM] DIA. MAX. SPHERICAL SOLIDS
CURVE FOR PARALLEL APPLICATION ONLY &
SHOULD NOT BE USED FOR SINGLE PUMP
PERFORMANCE

NOTE: See single pump curve for
horsepower, efficiency, & NPSH

2 PUMPS IN PARALLEL

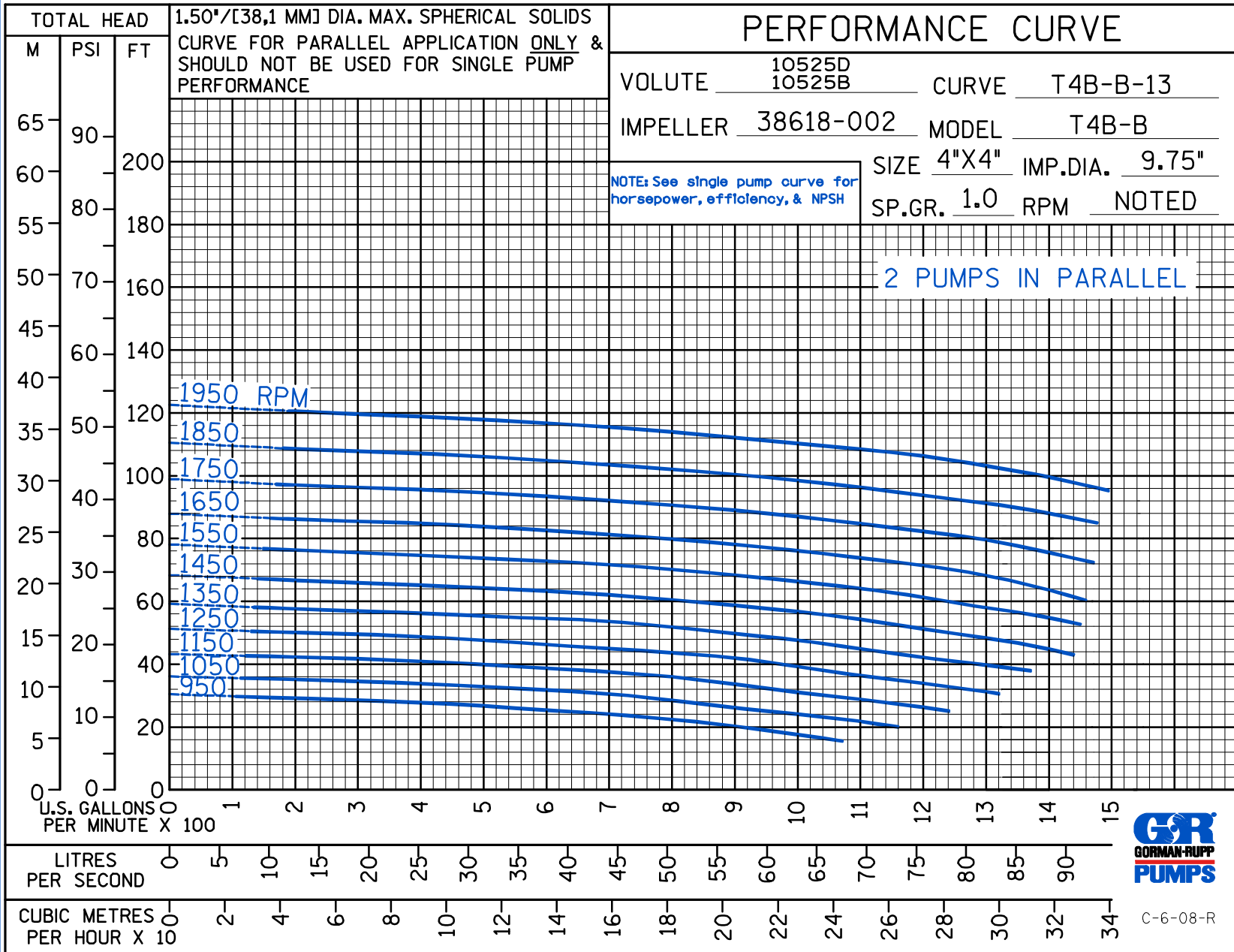

C-6-08-R



THE GORMAN-RUPP COMPANY • MANSFIELD, OHIO

GORMAN-RUPP OF CANADA LIMITED • ST. THOMAS, ONTARIO, CANADA

www.grpumps.com

Specifications Subject to Change Without Notice

Printed in U.S.A.

D S W

PERFORMANCE CURVE

VOLUTE 10525D
 10525B CURVE T4B-B-14
 IMPELLER 38618-002 MODEL T4B-B
 SIZE 4"X4" IMP.DIA. 9.75"
 SP.GR. 1.0 RPM NOTED

Performance shown does not include any interconnecting piping

NOTE: Series operation is limited by the operating pressure & NPSH requirement of a single pump. See single pump curve for NPSH, EFF., & HP.

2 PUMPS IN SERIES

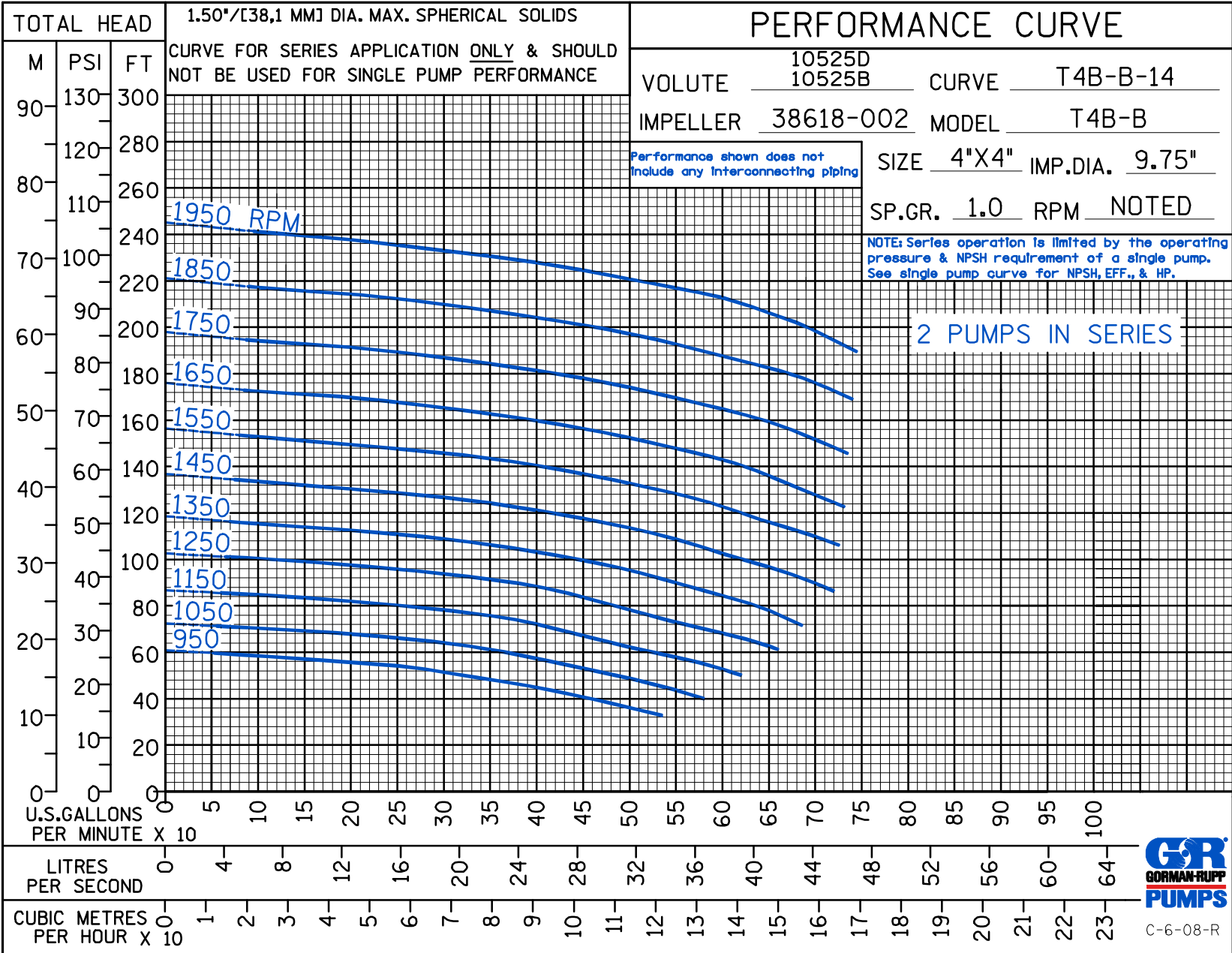

C-6-08-R



THE GORMAN-RUPP COMPANY • MANSFIELD, OHIO
 GORMAN-RUPP OF CANADA LIMITED • ST. THOMAS, ONTARIO, CANADA
 www.grpumps.com

Specifications Subject to Change Without Notice

Printed in U.S.A.