

## Basic Pump

C W

## Self Priming Centrifugal Pump

*Super*  
**T SERIES**

Model T8A60S-B

Size 8" x 8"



VARIOUS PATENTS APPLY

## PUMP SPECIFICATIONS

**Size:** 8" (203 mm) ASA Flanged Suction x 8" (203 mm) NPT Female Discharge.

**Casing:** Gray Iron 30.

Maximum Operating Pressure 83 psi (572 kPa).\*

**Semi-Open Type, Two Vane Impeller:** Ductile Iron 65-45-12.

Handles 3" (76.2 mm) Diameter Spherical Solids.

**Impeller Shaft:** Alloy Steel 4150.

**Shaft Sleeve:** Alloy Steel 4130.

**Replaceable Wear Plate:** Gray Iron 30.

**Removable Adjustable Cover Plate:** Gray Iron 30;  
94 lbs. (43 kg).

**Flap Valve:** Neoprene w/Nylon and Steel Reinforcing.

**Seal Plate:** Gray Iron 30.

**Bearing Housing:** Gray Iron 30.

**Radial and Thrust Bearings:** Open Double Row Ball.

**Bearing and Seal Cavity Lubrication:** SAE 30 Non-Detergent Oil.

**Flanges:** 125# Gray Iron 30.

**Gaskets:** Buna-N, Compressed Synthetic Fibers, PTFE, Cork,  
and Rubber.

**O-Rings:** Buna-N.

**Hardware:** Standard Plated Steel.

**Brass Pressure Relief Valve.**

**Bearing and Seal Cavity Oil Level Sight Gauges.**

**Optional Equipment:** Metal Bellows Seal. Automatic Air

Release Valve. 120V/240V Casing Heater. High Pump

Temperature Shutdown Kit. Self-Cleaning Wear Plate.

Gray Iron 30 Spool Flanges:

8" ASA Discharge (**Specify Model T8A60S-B /F**).

200 mm DIN 2527 (PN 16) Suction and Discharge

(**Specify Model T8A60S-B /FM**).

*\*Consult Factory for Applications Exceeding  
Maximum Pressure and/or Temperature Indicated.*



Shown with Optional Discharge Spool Flange (Available in ASA or DIN Standard Sizes).

## SEAL SPECIFICATIONS

Cartridge Type, Mechanical, Oil-Lubricated, Double Floating, Self-Aligning. Silicon Carbide Rotating and Stationary Faces. Stainless Steel 316 Stationary Seat. Fluorocarbon Elastomers (DuPont Viton® or Equivalent). Stainless Steel 18-8 Cage and Spring. Maximum Temperature of Liquid Pumped, 160°F (71°C).\*

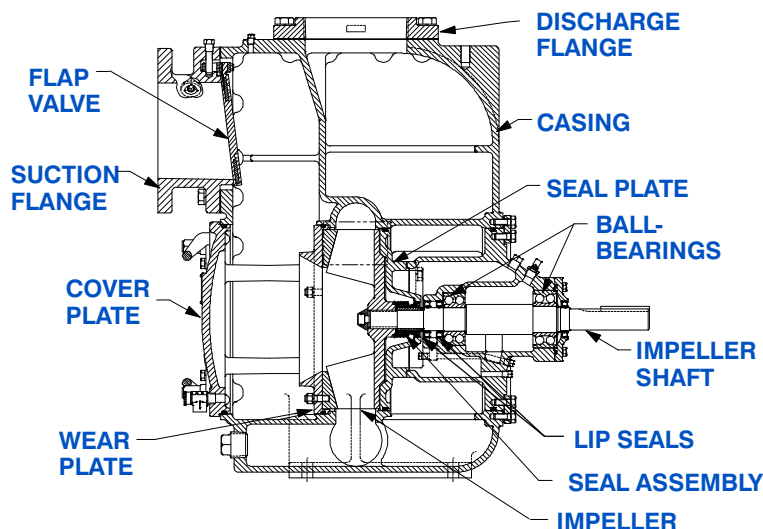

## SEAL DETAIL

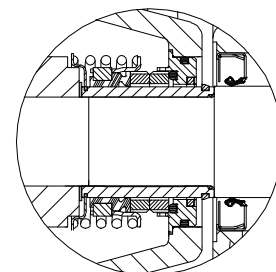

THE GORMAN-RUPP COMPANY • MANSFIELD, OHIO

GORMAN-RUPP OF CANADA LIMITED • ST. THOMAS, ONTARIO, CANADA

www.grpumps.com

Specifications Subject to Change Without Notice

Printed in U.S.A.

**Specification Data**

SECTION 55, PAGE 2310

**APPROXIMATE DIMENSIONS and WEIGHTS**

**NET WEIGHT: 1295 LBS. (587 KG.)\***  
**SHIPPING WEIGHT: 1399 LBS. (635 KG.)\***  
**EXPORT CRATE: 47.9 CU. FT. (1,36 CU. M.)**  
**\*ADD 35 LBS. (15,9 KG.) W/EACH SPOOL FLANGE**

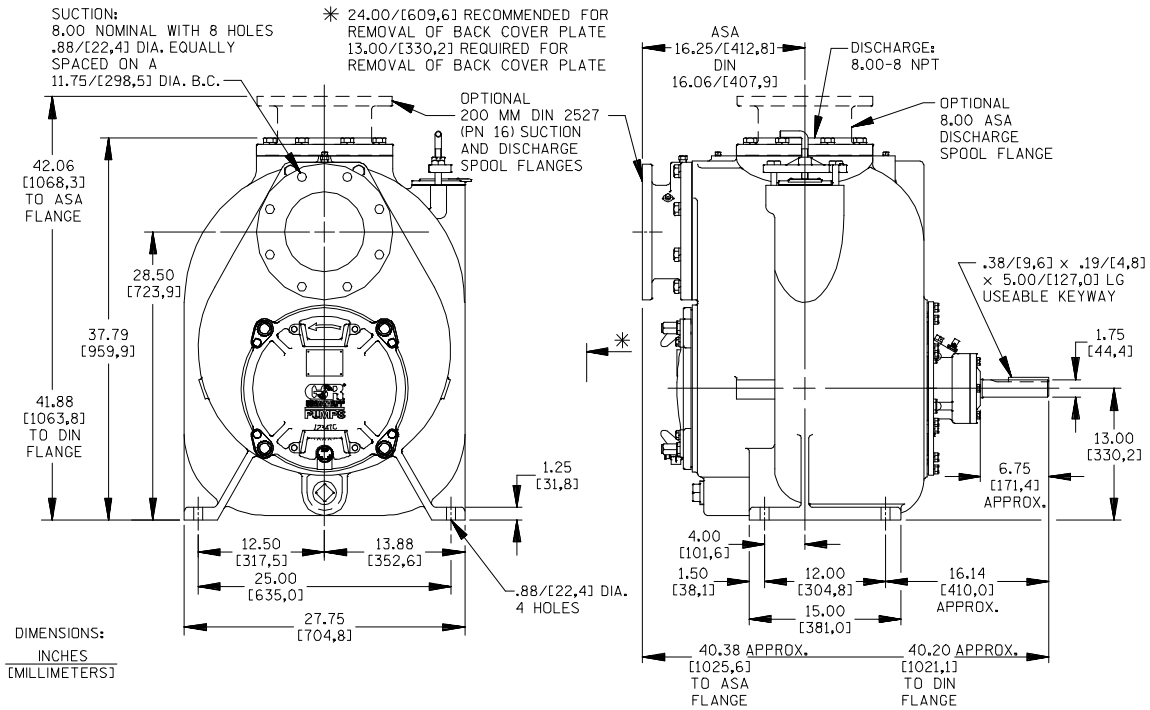

**OPTIONAL ASA OR DIN STANDARD SPOOL FLANGES AVAILABLE**

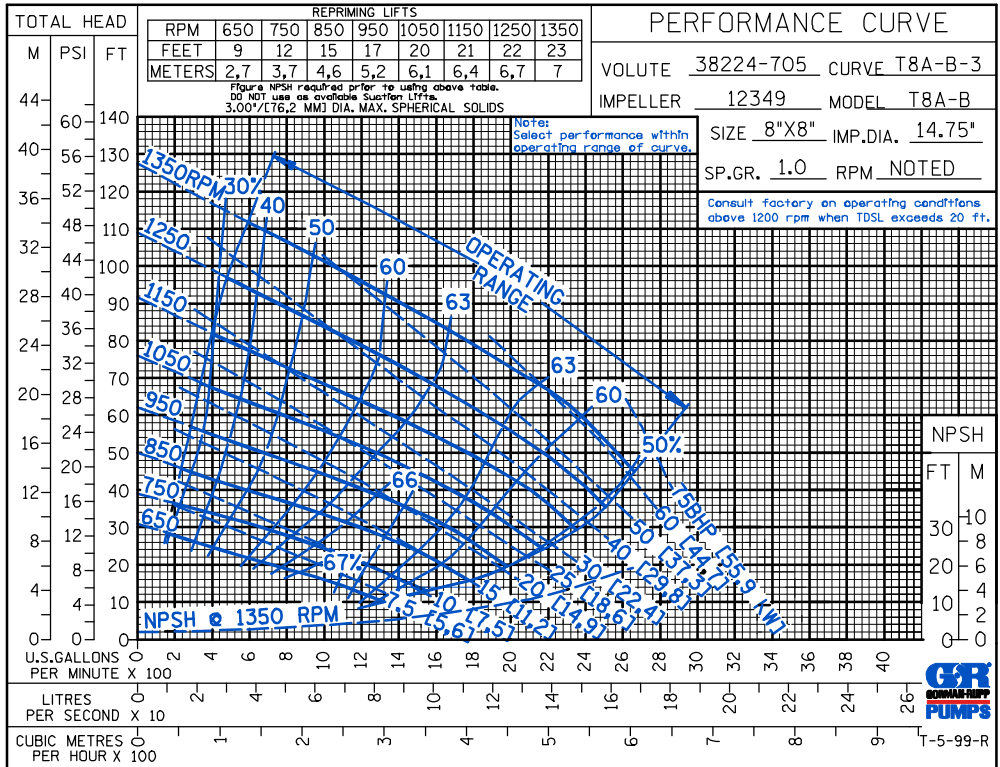

**THE GORMAN-RUPP COMPANY • MANSFIELD, OHIO**

GORMAN-RUPP OF CANADA LIMITED • ST. THOMAS, ONTARIO, CANADA

Specifications Subject to Change Without Notice

Printed in U.S.A.



**THE GORMAN-RUPP COMPANY • MANSFIELD, OHIO**  
 GORMAN-RUPP OF CANADA LIMITED • ST. THOMAS, ONTARIO, CANADA  
 www.grpumps.com

© Copyright by the Gorman-Rupp Company 2009

Specifications Subject to Change Without Notice

Printed in U.S.A.

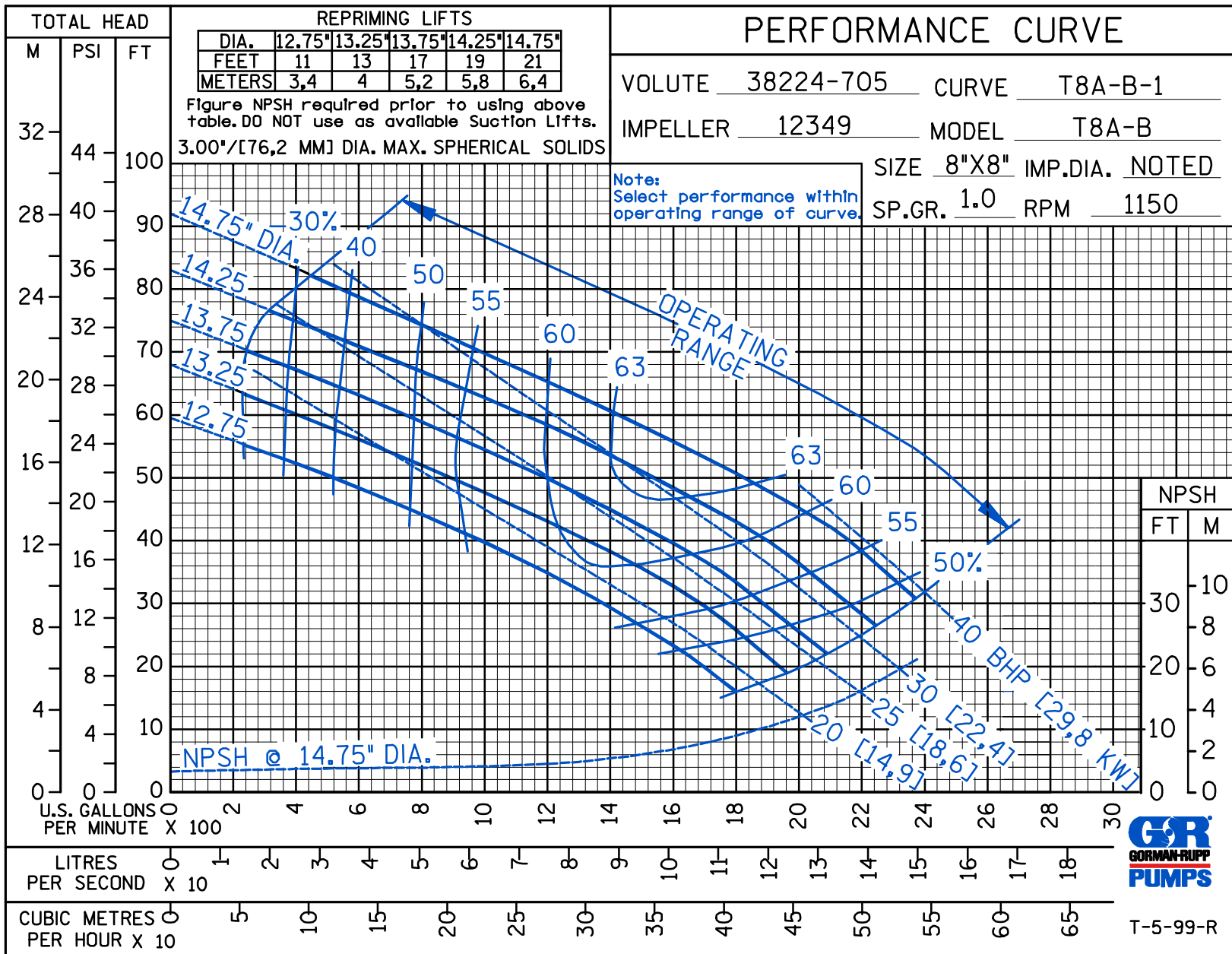

CDS

Curve Data

Sec. 55

PAGE 2351.1  
 SEPTEMBER 2009



T-5-99-R



**THE GORMAN-RUPP COMPANY • MANSFIELD, OHIO**  
 GORMAN-RUPP OF CANADA LIMITED • ST. THOMAS, ONTARIO, CANADA  
 www.grpumps.com

Specifications Subject to Change Without Notice

Printed in U.S.A.

© Copyright by the Gorman-Rupp Company 2009

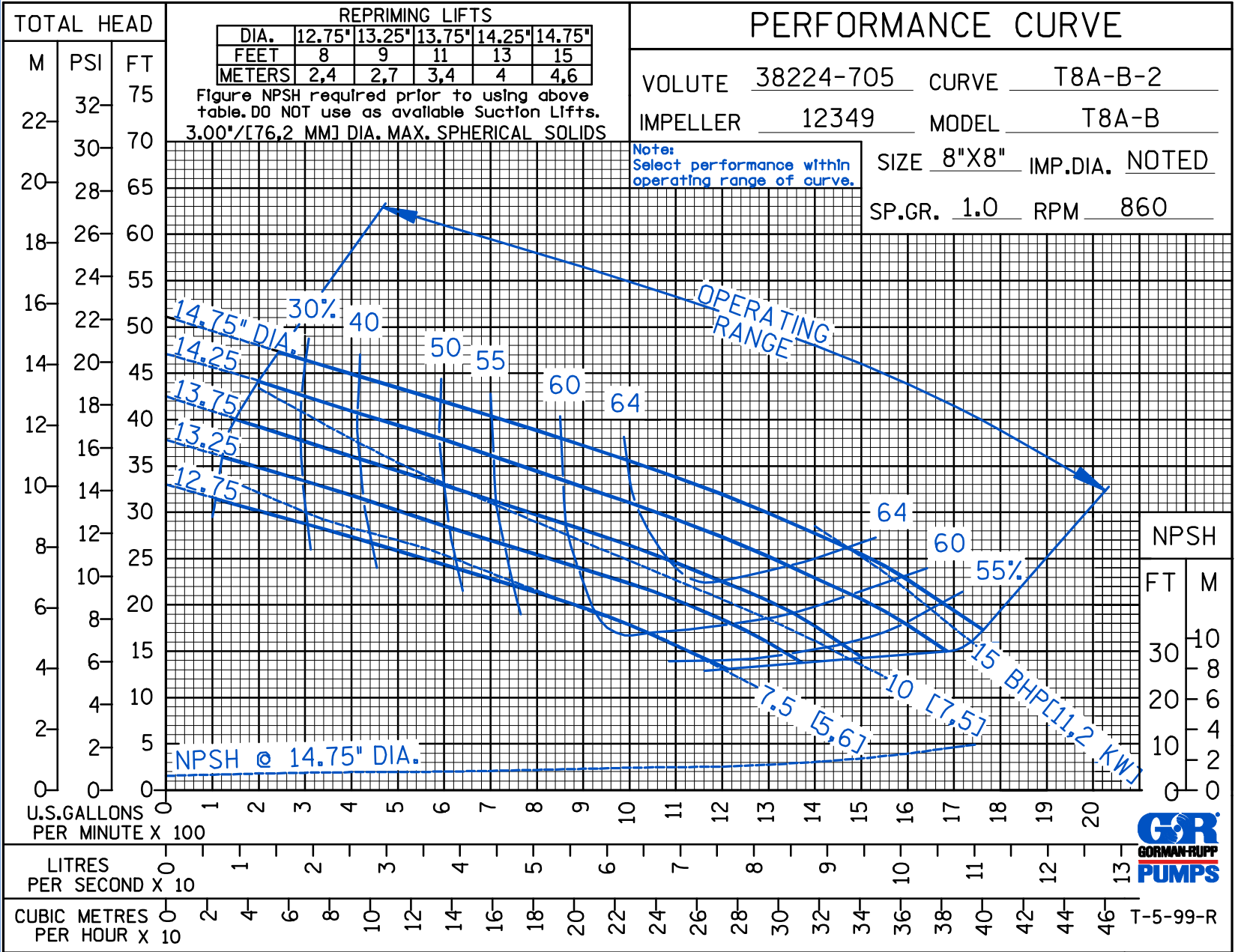

CDS

Curve Data

Sec. 55

PAGE 2351.2  
 SEPTEMBER 2009



T-5-99-R

CDS

PERFORMANCE CURVE

VOLUTE 38224-705 CURVE T8A-B-3

IMPELLER 12349 MODEL T8A-B

SIZE 8"X8" IMP.DIA. 14.75"

SP.GR. 1.0 RPM NOTED

Consult factory on operating conditions above 1200 rpm when TDSL exceeds 20 ft.

REPRIMING LIFTS								
RPM	650	750	850	950	1050	1150	1250	1350
FEET	9	12	15	17	20	21	22	23
METERS	2,7	3,7	4,6	5,2	6,1	6,4	6,7	7

Figure NPSH required prior to using above table.  
DO NOT use as available Suction Lifts.  
3.00"/[76,2 MM] DIA. MAX. SPHERICAL SOLIDS

Note:  
Select performance within  
operating range of curve.

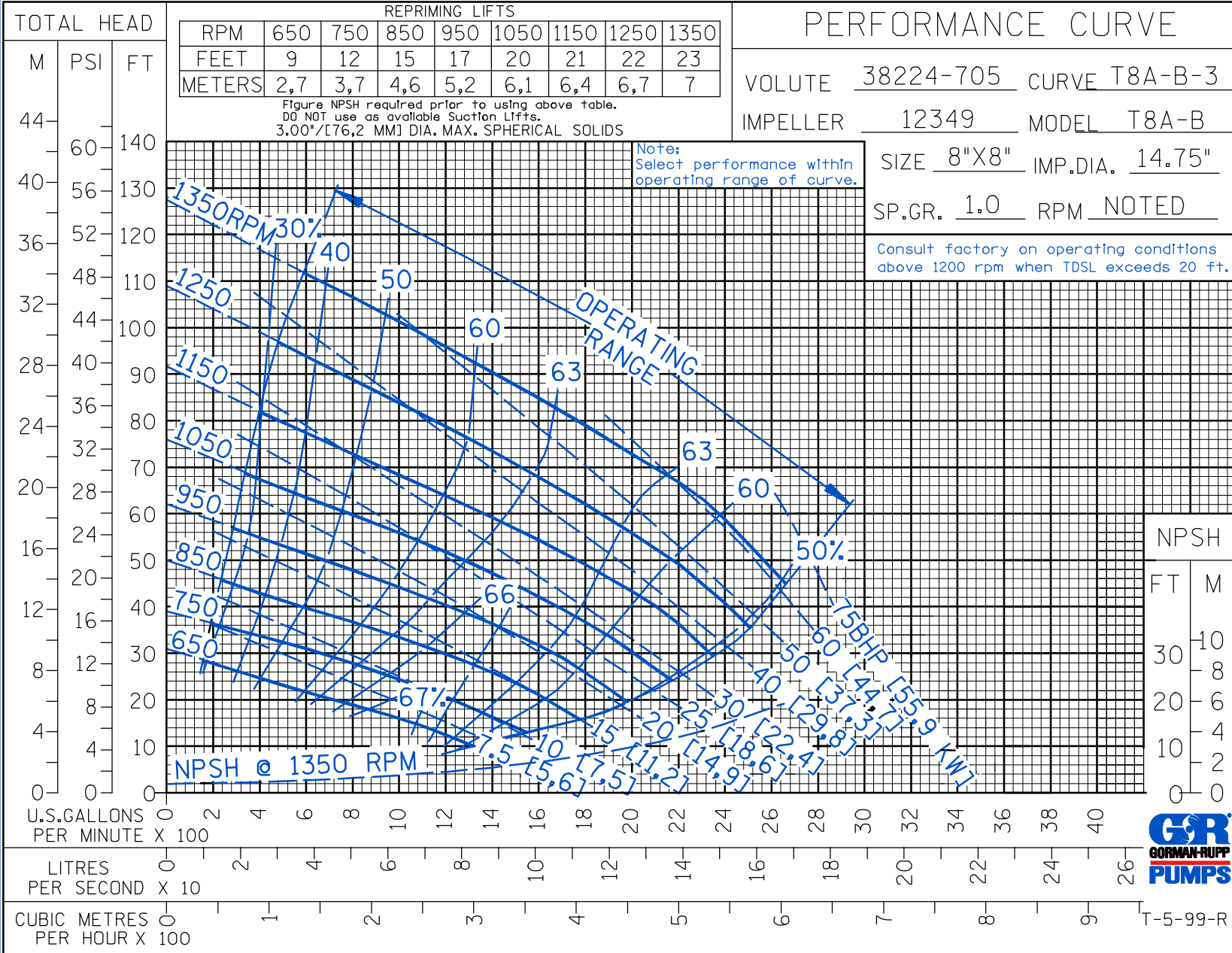

NPSH

FT M

30 10

8 8

20 6

10 4

0 2

0 0

T-5-99-R

GORMAN-RUPP PUMPS



THE GORMAN-RUPP COMPANY • MANSFIELD, OHIO

GORMAN-RUPP OF CANADA LIMITED • ST. THOMAS, ONTARIO, CANADA

www.grpumps.com

Specifications Subject to Change Without Notice

Printed in U.S.A.



CDS

# PERFORMANCE CURVE

VOLUTE 38224-705 CURVE T8A-B-4  
 IMPELLER 12349 MODEL T8A-B  
 SIZE 8"X8" IMP.DIA. 14.25"  
 SP.GR. 1.0 RPM NOTED

Consult factory on operating conditions above 1200 rpm when TDSL exceeds 20 ft.

Note:  
Select performance within operating range of curve.

REPRIMING LIFTS									
RPM	650	750	850	950	1050	1150	1250	1350	1450
FEET	8	10	13	16	18	19	21	23	24
METERS	2,4	3,1	4	4,9	5,5	5,8	6,4	7	7,3

Figure NPSH required prior to using above table.  
 DO NOT use as available Suction Lifts.  
 3.00"/[76,2 MM] DIA. MAX. SPHERICAL SOLIDS

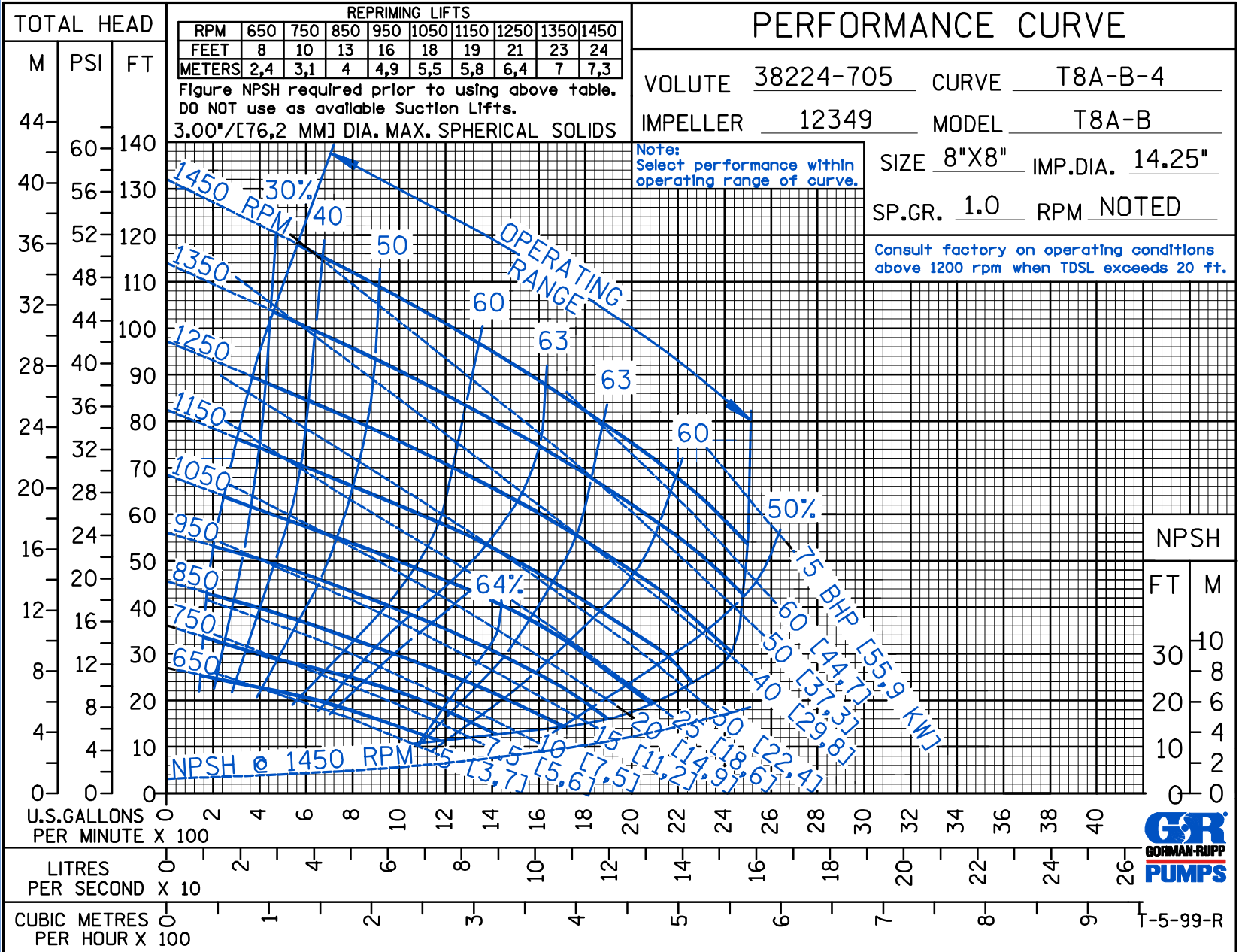

NPSH

FT M  
 10 8 6 4 2 0  
 30 20 10 0



T-5-99-R



**THE GORMAN-RUPP COMPANY • MANSFIELD, OHIO**  
 GORMAN-RUPP OF CANADA LIMITED • ST. THOMAS, ONTARIO, CANADA

www.grpumps.com  
 Specifications Subject to Change Without Notice

Printed in U.S.A.



**THE GORMAN-RUPP COMPANY • MANSFIELD, OHIO**  
 GORMAN-RUPP OF CANADA LIMITED • ST. THOMAS, ONTARIO, CANADA  
 www.grpumps.com

© Copyright by the Gorman-Rupp Company 2009

Specifications Subject to Change Without Notice

Printed in U.S.A.

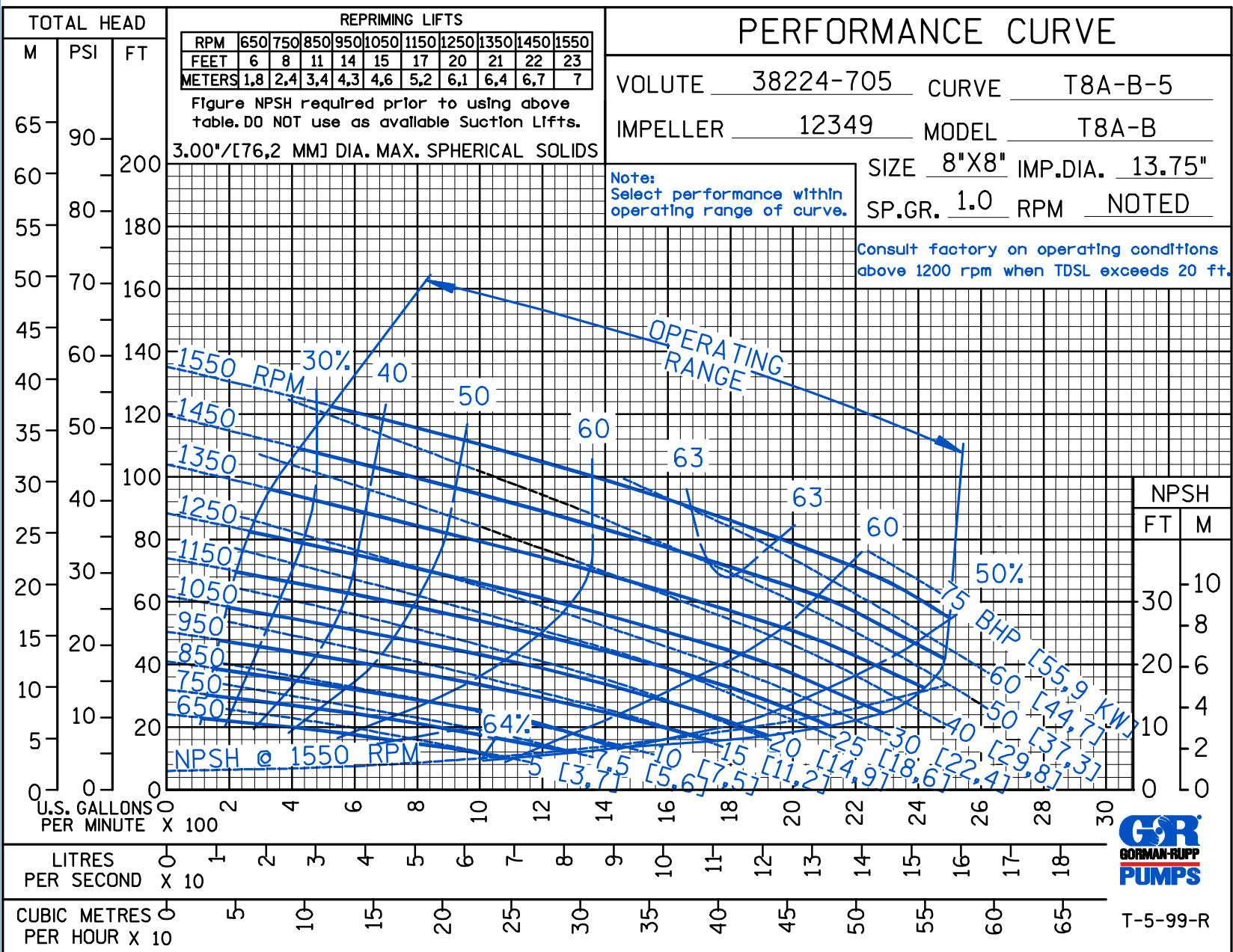

CDS

Curve Data

Sec. 55

PAGE 2351.5  
 SEPTEMBER 2009



**THE GORMAN-RUPP COMPANY • MANSFIELD, OHIO**  
 GORMAN-RUPP OF CANADA LIMITED • ST. THOMAS, ONTARIO, CANADA  
 www.grpumps.com

© Copyright by the Gorman-Rupp Company 2009

Specifications Subject to Change Without Notice

Printed in U.S.A.

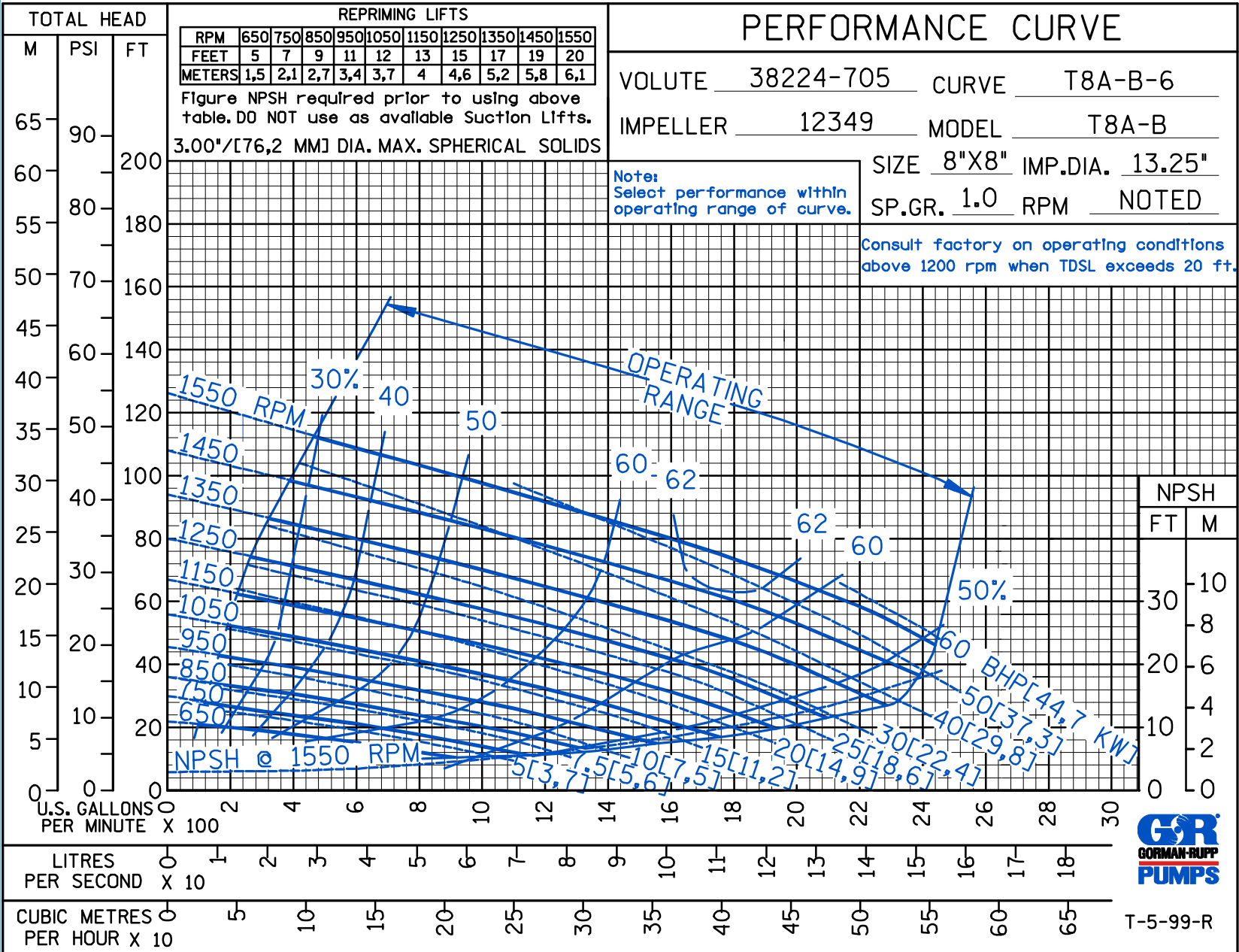

Curve Data

CDS

Sec. 55

PAGE 2351.6  
 SEPTEMBER 2009





**THE GORMAN-RUPP COMPANY • MANSFIELD, OHIO**  
 GORMAN-RUPP OF CANADA LIMITED • ST. THOMAS, ONTARIO, CANADA  
 www.grpumps.com

© Copyright by the Gorman-Rupp Company 2009

Specifications Subject to Change Without Notice

Printed in U.S.A.

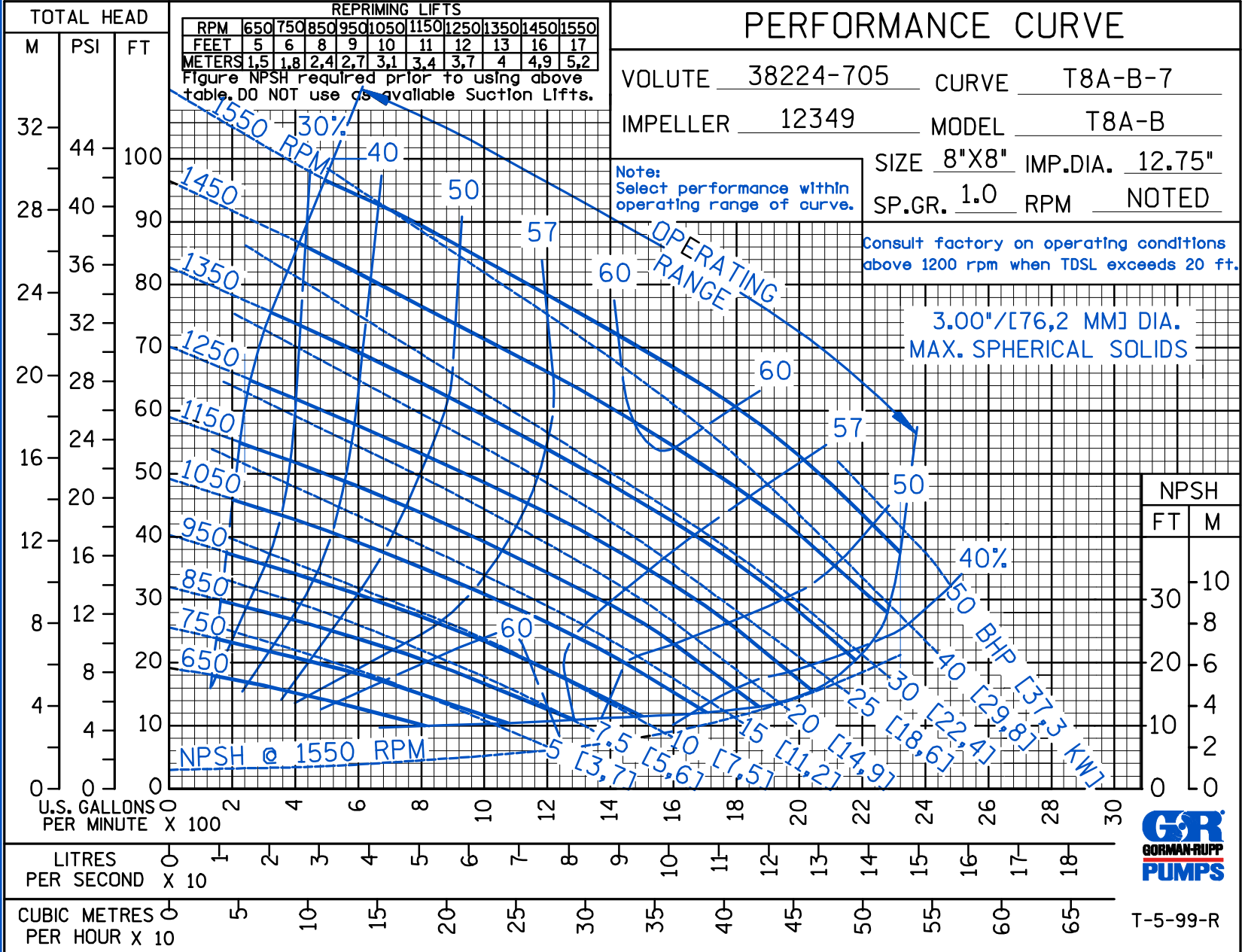

CDS

Curve Data

Sec. 55

PAGE 2351.7  
 SEPTEMBER 2009



THE GORMAN-RUPP COMPANY • MANSFIELD, OHIO  
 GORMAN-RUPP OF CANADA LIMITED • ST. THOMAS, ONTARIO, CANADA  
 www.grpumps.com

© Copyright by the Gorman-Rupp Company 2009

Specifications Subject to Change Without Notice

Printed in U.S.A.

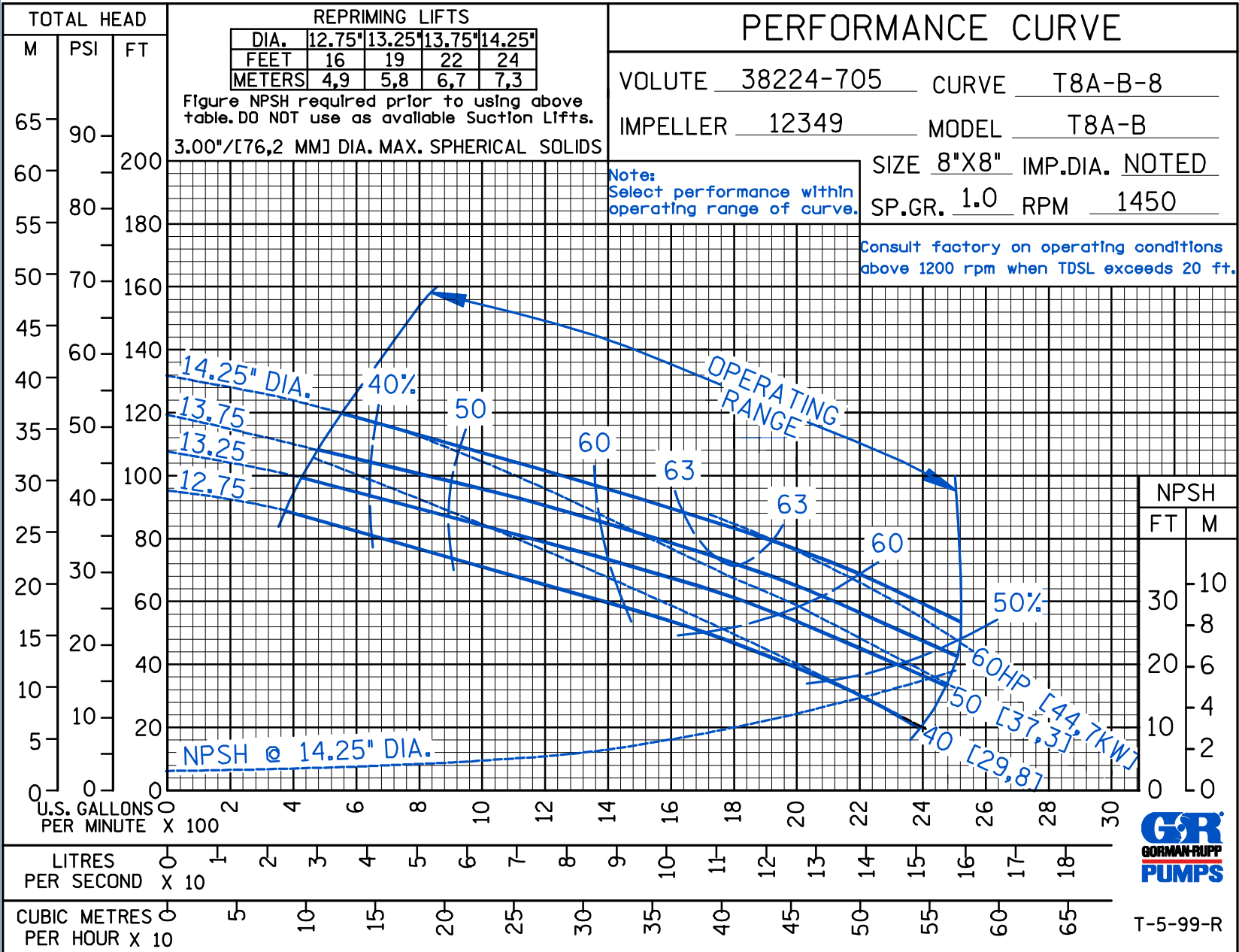

CDS

Curve Data

Sec. 55

PAGE 2351.8  
 SEPTEMBER 2009



THE GORMAN-RUPP COMPANY • MANSFIELD, OHIO

GORMAN-RUPP OF CANADA LIMITED • ST. THOMAS, ONTARIO, CANADA

www.grpumps.com

Specifications Subject to Change Without Notice

© Copyright by the Gorman-Rupp Company 2009

Printed in U.S.A.

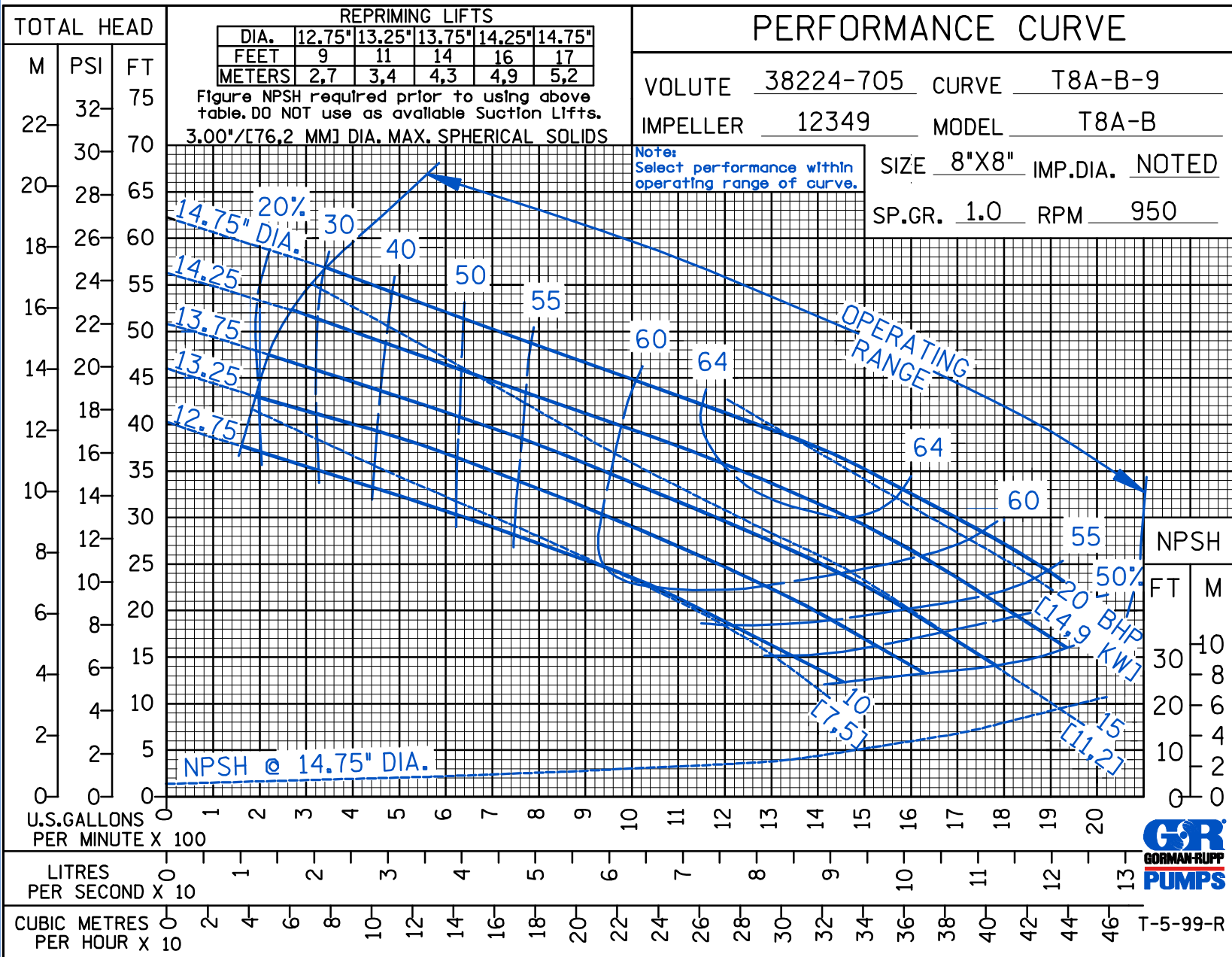

CDS

Curve Data

Sec. 55  
PAGE 2351.9  
SEPTEMBER 2009



T-5-99-R



THE GORMAN-RUPP COMPANY • MANSFIELD, OHIO  
 GORMAN-RUPP OF CANADA LIMITED • ST. THOMAS, ONTARIO, CANADA  
 www.grpumps.com

© Copyright by the Gorman-Rupp Company 2009

Specifications Subject to Change Without Notice

Printed in U.S.A.

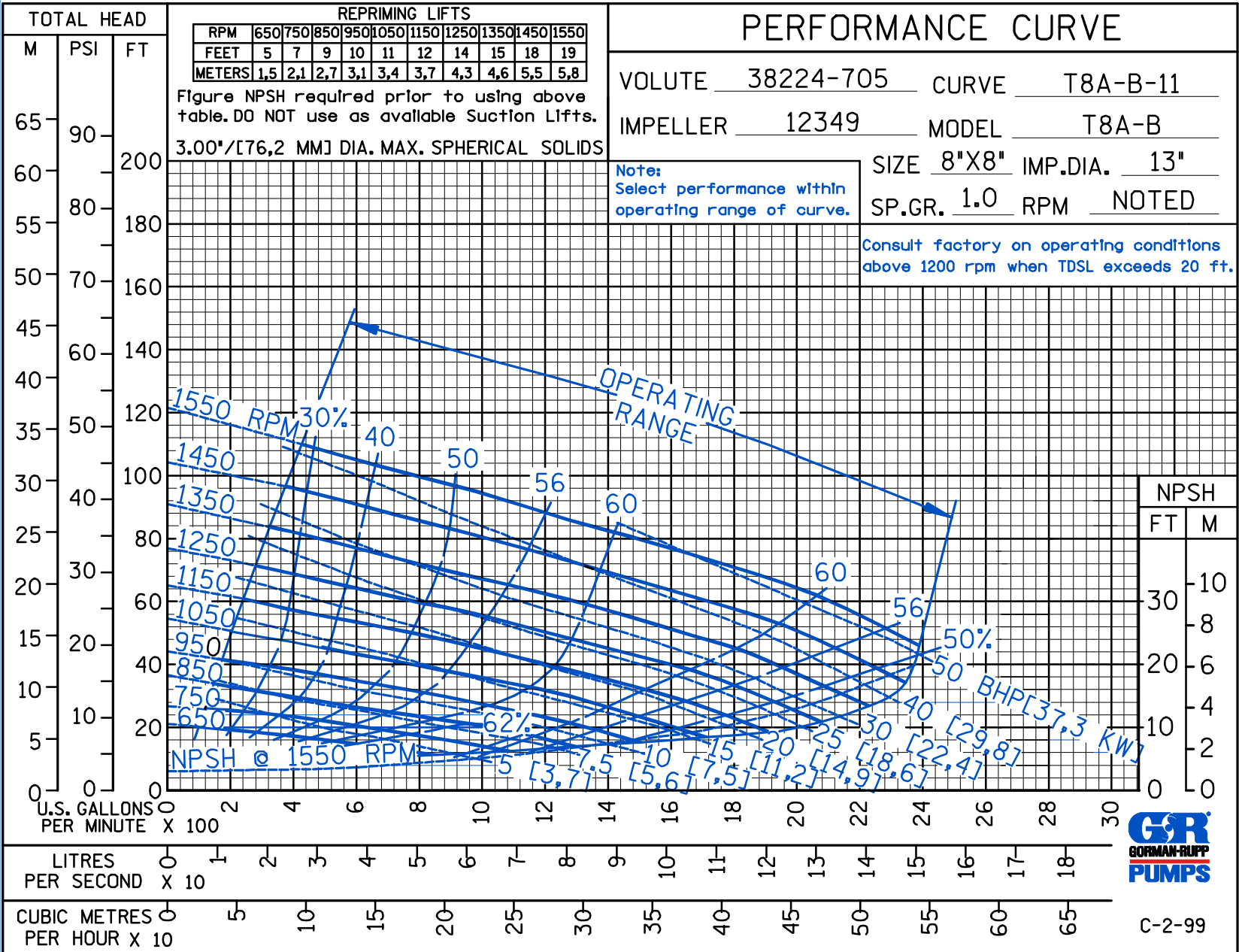

Curve Data

CDS

Sec. 55

PAGE 2351.10  
 SEPTEMBER 2009

DS

### PERFORMANCE CURVE

VOLUTE 38224-705 CURVE T8A-B-12  
 IMPELLER 12349 MODEL T8A-B  
 SIZE 8"X8" IMP.DIA. 14.75"  
 SP.GR. 1.0 RPM NOTED

NOTE: See single pump curve for horsepower, efficiency, & NPSH

Consult factory on operating conditions above 1200 rpm when TDSL exceeds 20 ft.

2 PUMPS IN PARALLEL

3.00"/[76,2 MM] DIA. MAX. SPHERICAL SOLIDS CURVE FOR PARALLEL APPLICATION ONLY & SHOULD NOT BE USED FOR SINGLE PUMP PERFORMANCE

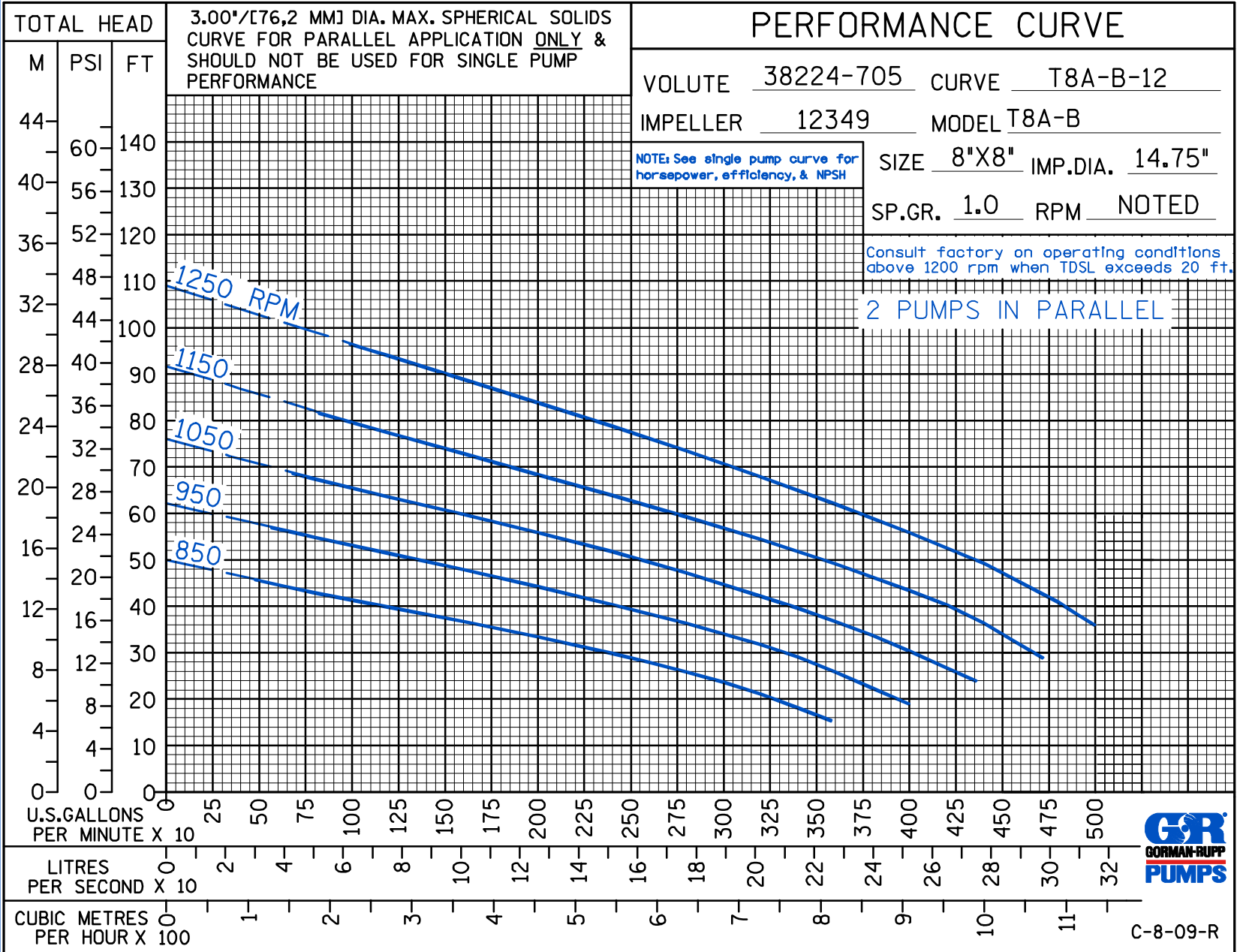

C-8-09-R



THE GORMAN-RUPP COMPANY • MANSFIELD, OHIO  
 GORMAN-RUPP OF CANADA LIMITED • ST. THOMAS, ONTARIO, CANADA  
 www.grpumps.com

Specifications Subject to Change Without Notice

Printed in U.S.A.



DS

# PERFORMANCE CURVE

VOLUTE 38224-705 CURVE T8A-B-13  
 IMPELLER 12349 MODEL T8A-B  
 SIZE 8"X8" IMP.DIA. 14.75"  
 SP.GR. 1.0 RPM NOTED

Performance shown does not include any interconnecting piping

NOTE: Series operation is limited by the operating pressure & NPSH requirement of a single pump. See single pump curve for NPSH, EFF., & HP.

Consult factory on operating conditions above 1200 rpm when TDSL exceeds 20 ft.

2 PUMPS IN SERIES

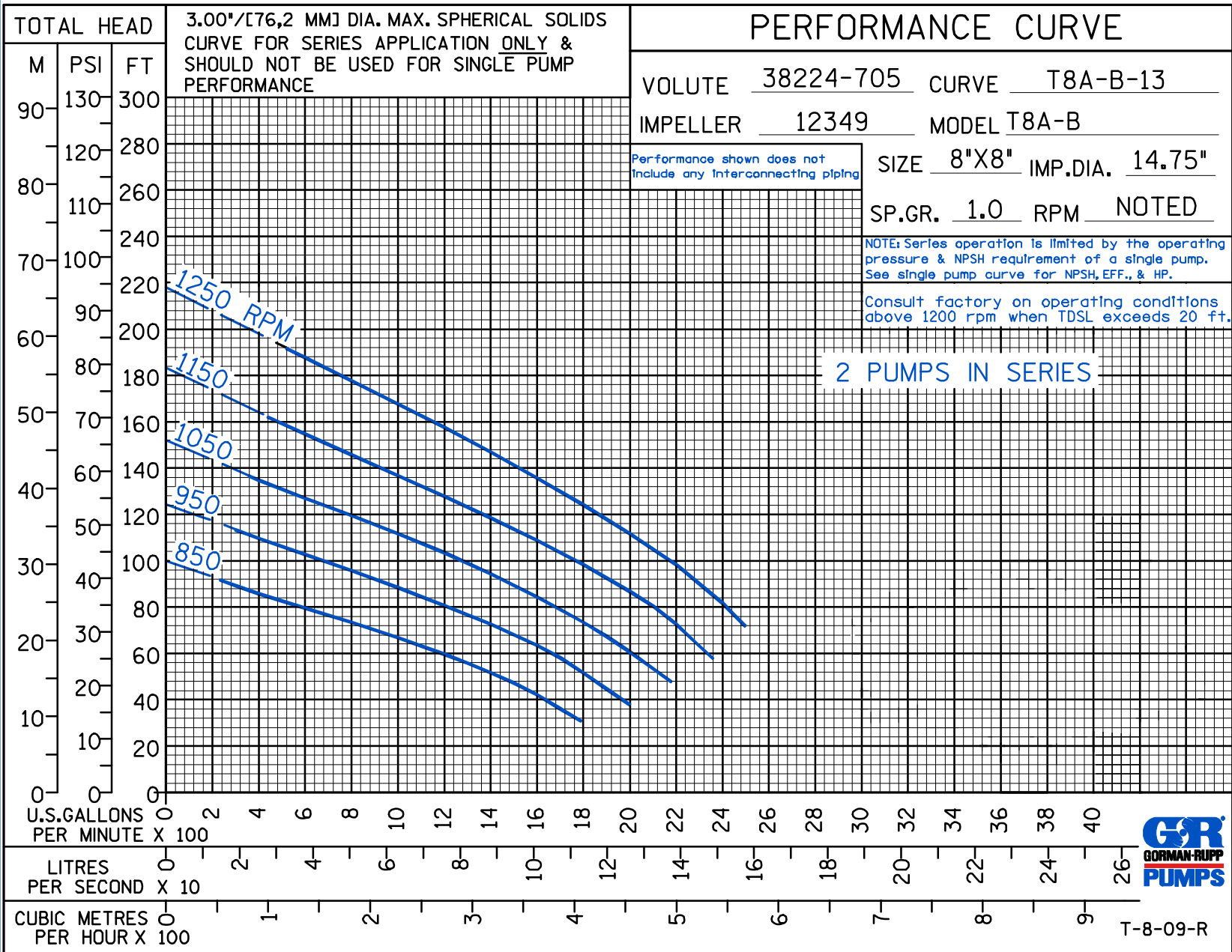

T-8-09-R



**THE GORMAN-RUPP COMPANY • MANSFIELD, OHIO**  
 GORMAN-RUPP OF CANADA LIMITED • ST. THOMAS, ONTARIO, CANADA

www.grpumps.com  
 Specifications Subject to Change Without Notice

Printed in U.S.A.