

CDS

# Self Priming Centrifugal Pump

**Super  
T SERIES**

VARIOUS PATENTS APPLY

**Model T4B61S-B****Size 4" x 4"****PUMP SPECIFICATIONS****Size:** 4" x 4" (101 mm x 101 mm) NPT - Female.**Casing:** Gray Iron 30.

Maximum Operating Pressure 97 psi (669 kPa).\*

**Semi-Open Type, Five Vane Impeller:** Stainless Steel 316.

Handles 1 1/2" (38,1 mm) Diameter Spherical Solids.

**Impeller Shaft:** Stainless Steel 17-4 PH.**Replaceable Wear Plate:** Stainless Steel 316.**Removable Adjustable Cover Plate:** Gray Iron 30; 42 lbs. (19 kg).**Flap Valve:** Neoprene<sup>™</sup>/Nylon and Steel Reinforcing.**Seal Plate:** Stainless Steel 316.**Bearing Housing:** Gray Iron 30.**Radial Bearing:** Open Single Row Ball.**Thrust Bearing:** Open Double Row Ball.**Bearing and Seal Cavity Lubrication:** SAE 30 Non-Detergent Oil.**Flanges:** 125# Gray Iron 30.**Gaskets:** Buna-N, Compressed Synthetic Fibers, Vegetable Fiber, PTFE, Cork, and Rubber.**O-Rings:** Buna-N.**Internal Wetted Hardware:** Stainless Steel 316.**External Hardware:** Standard Plated Steel.**Pressure Relief Valve:** Stainless Steel 316.**Bearing and Seal Cavity Oil Level Sight Gauges.****Optional Equipment:** Metal Bellows Seal. Automatic Air Release Valve.

Stainless Steel CD4MCu Impeller, Seal Plate and Wear Plate.

120V/240V Casing Heater. High Pump Temperature Shutdown Kit.

Gray Iron 30 Suction and Discharge Spool Flanges:

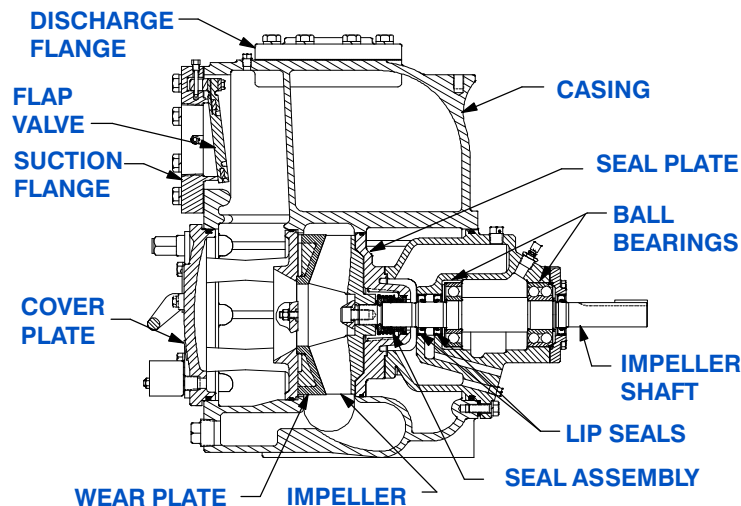
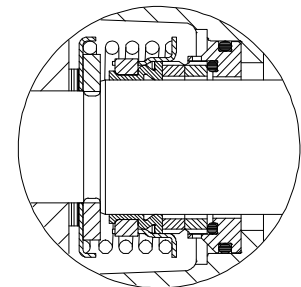
4" ASA (**Specify Model T4B61S-B /F**).100 mm DIN 2527 (PN 16) (**Specify Model T4B61S-B /FM**).*\*Consult Factory for Applications Exceeding Maximum Pressure and/or Temperature Indicated.***Shown with Optional Suction & Discharge Spool Flanges (Available in ASA or DIN Standard Sizes).****SEAL SPECIFICATIONS**Mechanical, Oil-Lubricated, Double Floating, Self-Aligning. Silicon Carbide Rotating and Stationary Faces. Stainless Steel 316 Stationary Seat. Fluorocarbon Elastomers (DuPont Viton<sup>®</sup> or Equivalent). Stainless Steel 18-8 Cage and Spring. Maximum Temperature of Liquid Pumped, 160°F (71°C).\***SEAL DETAIL****THE GORMAN-RUPP COMPANY • MANSFIELD, OHIO**

GORMAN-RUPP OF CANADA LIMITED • ST. THOMAS, ONTARIO, CANADA

www.grpumps.com

Specifications Subject to Change Without Notice

Printed in U.S.A.

**Specification Data**

SECTION 55, PAGE 2170

**APPROXIMATE DIMENSIONS and WEIGHTS**

**NET WEIGHT: 586 LBS. (266 KG.)**  
**SHIPPING WEIGHT: 625 LBS. (283 KG.)**  
**EXPORT CRATE: 22.7 CU. FT. (0,64 CU. M.)**  
**\*ADD 15 LBS. (6,8 KG.) W/EACH SPOOL FLANGE**

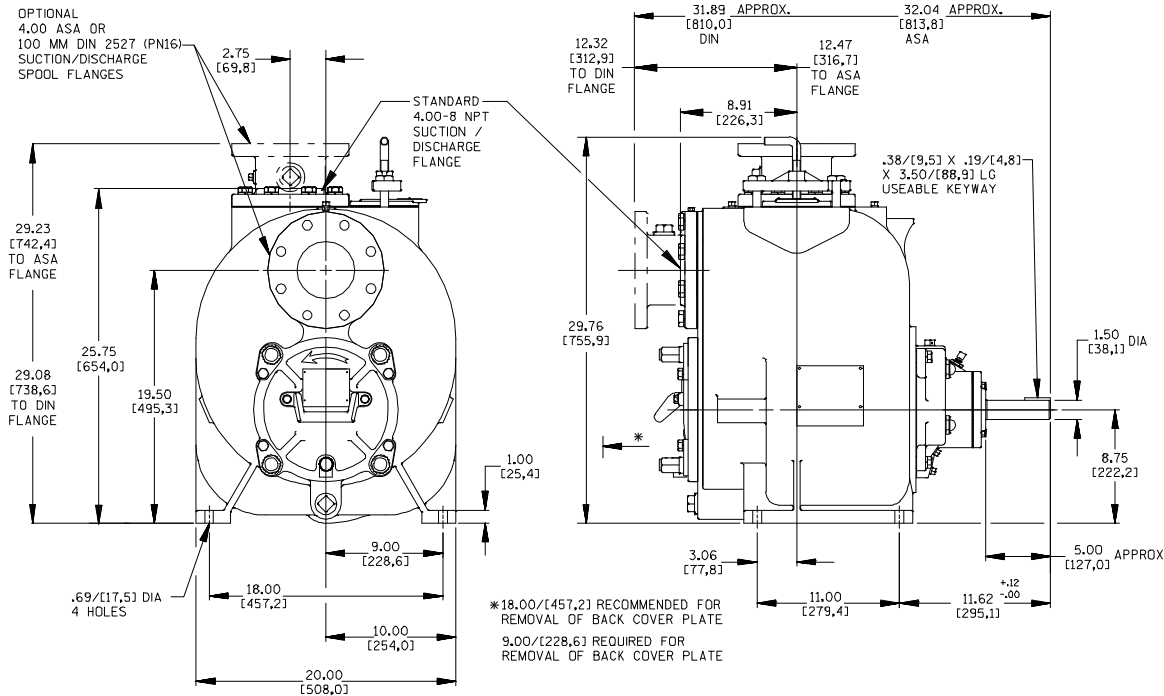

NOTE: OPTIONAL ASA OR DIN STANDARD SUCITON & DISCHARGE SPOOL FLANGES AVAILABLE.

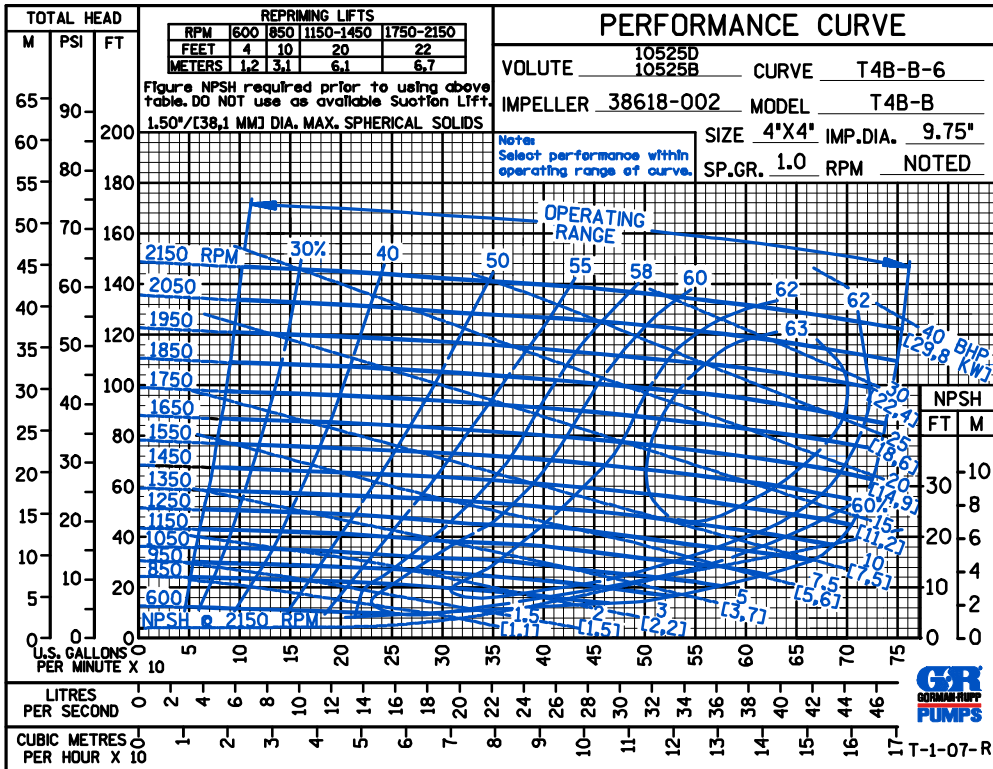

THE GORMAN-RUPP COMPANY • MANSFIELD, OHIO

GORMAN-RUPP OF CANADA LIMITED • ST. THOMAS, ONTARIO, CANADA

Specifications Subject to Change Without Notice

Printed in U.S.A.



THE GORMAN-RUPP COMPANY • MANSFIELD, OHIO

GORMAN-RUPP OF CANADA LIMITED • ST. THOMAS, ONTARIO, CANADA

www.grpumps.com

Specifications Subject to Change Without Notice

Printed in U.S.A.

© Copyright by the Gorman-Rupp Company 2008

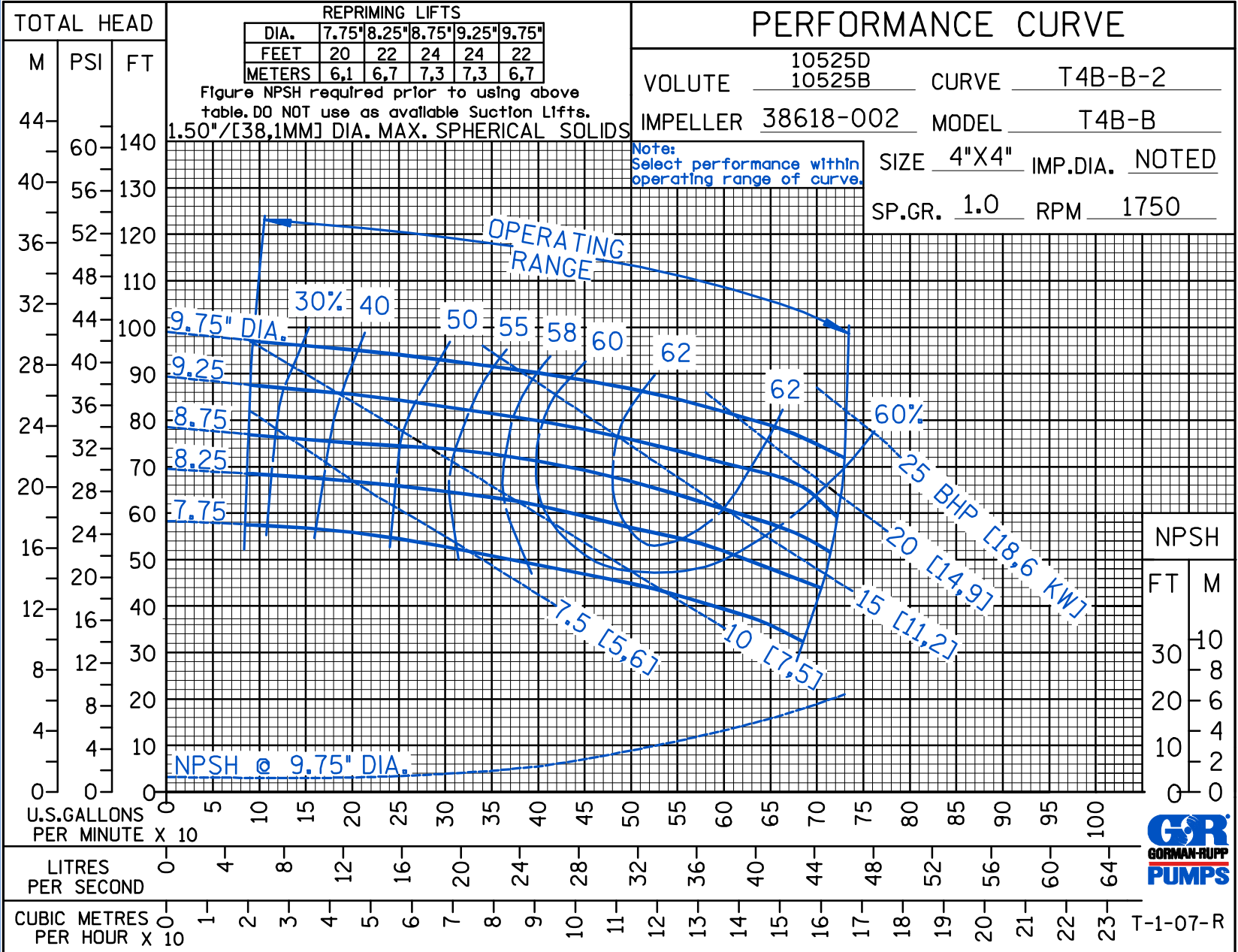

CDSW

Curve Data

Sec. 55

PAGE 2185.1  
JULY 2008



**THE GORMAN-RUPP COMPANY • MANSFIELD, OHIO**  
 GORMAN-RUPP OF CANADA LIMITED • ST. THOMAS, ONTARIO, CANADA  
 www.grpumps.com  
 Specifications Subject to Change Without Notice

© Copyright by the Gorman-Rupp Company 2008

Printed in U.S.A.

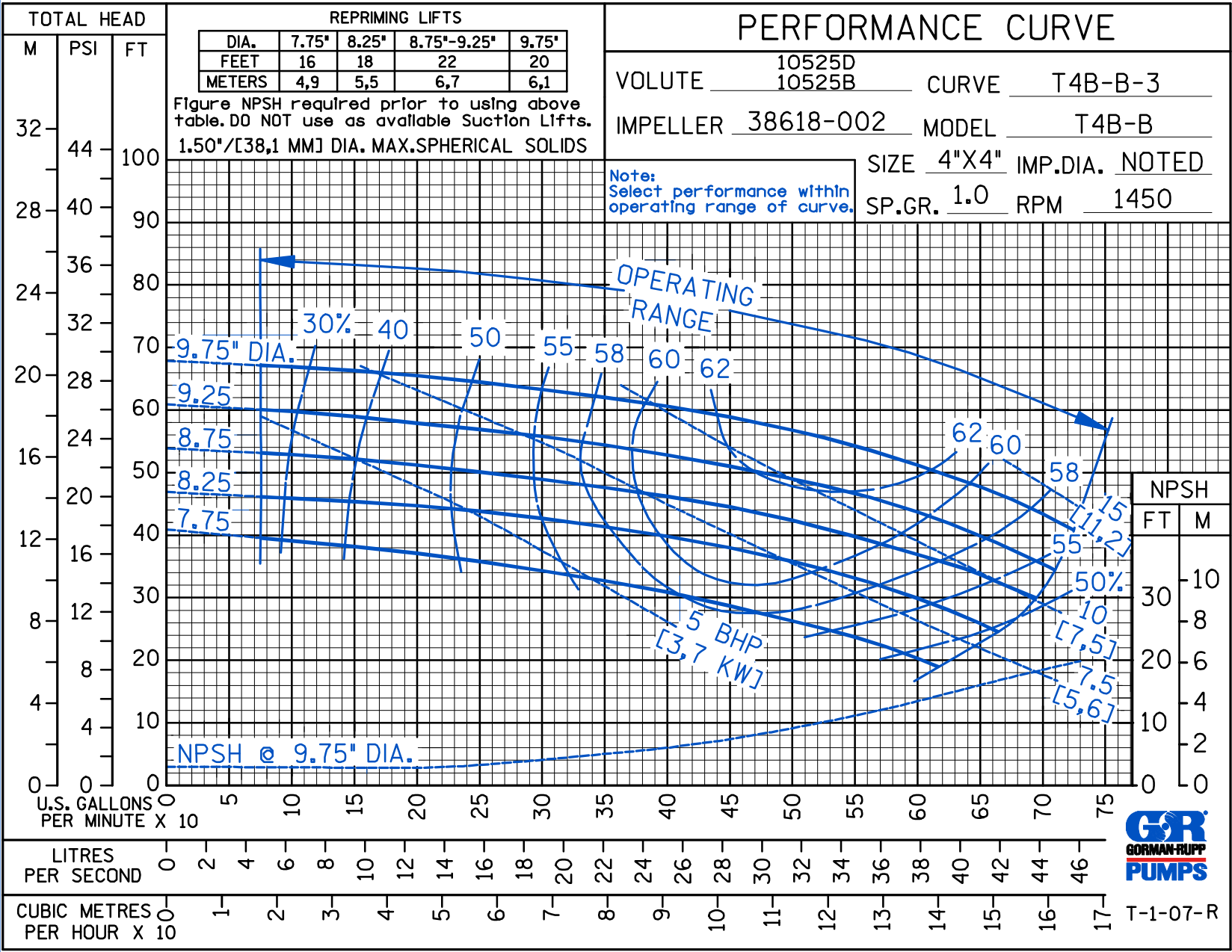

CDSW

Curve Data

Sec. 55

PAGE 2185.2  
 JULY 2008



T-1-07-R



THE GORMAN-RUPP COMPANY • MANSFIELD, OHIO  
 GORMAN-RUPP OF CANADA LIMITED • ST. THOMAS, ONTARIO, CANADA  
 www.grpumps.com

Specifications Subject to Change Without Notice

Printed in U.S.A.

© Copyright by the Gorman-Rupp Company 2008

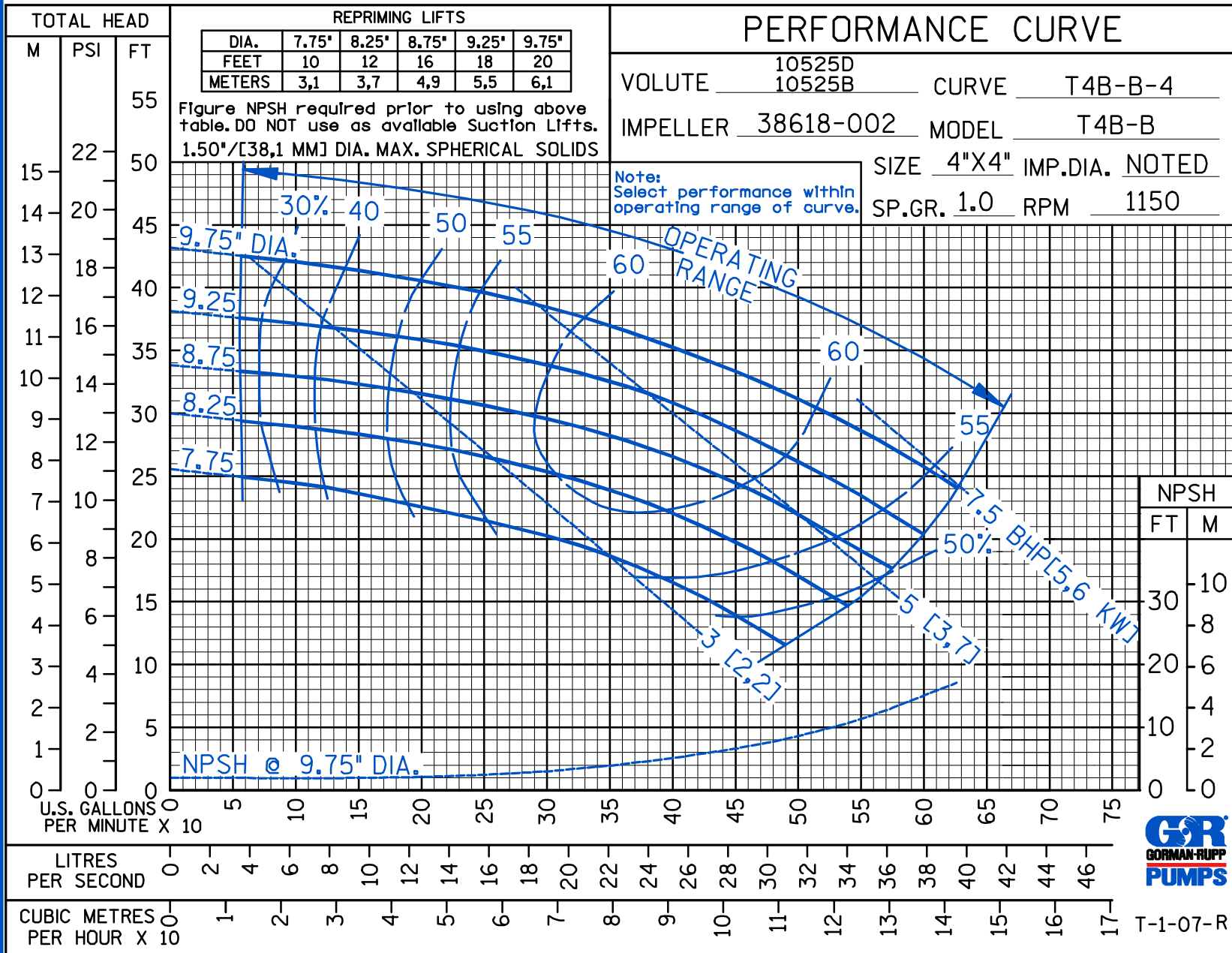

CDSW

Curve Data

Sec. 55

PAGE 2185.3  
 JULY 2008



**THE GORMAN-RUPP COMPANY • MANSFIELD, OHIO**  
 GORMAN-RUPP OF CANADA LIMITED • ST. THOMAS, ONTARIO, CANADA  
 www.grpumps.com

Specifications Subject to Change Without Notice

Printed in U.S.A.

© Copyright by the Gorman-Rupp Company 2008

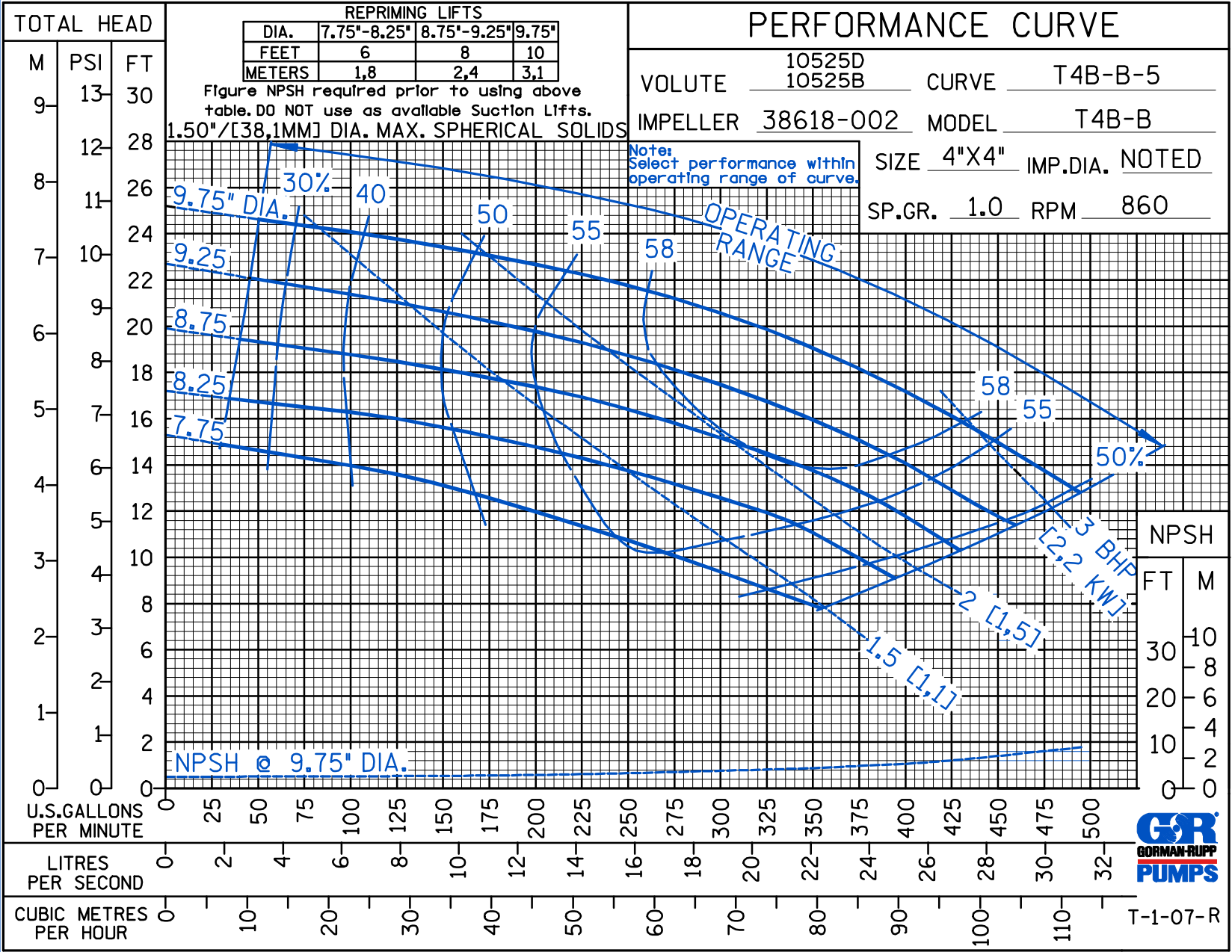

CDSW

Curve Data

Sec. 55

PAGE 2185.4  
JULY 2008



T-1-07-R



THE GORMAN-RUPP COMPANY • MANSFIELD, OHIO

GORMAN-RUPP OF CANADA LIMITED • ST. THOMAS, ONTARIO, CANADA

www.grpumps.com

Specifications Subject to Change Without Notice

Printed in U.S.A.

© Copyright by the Gorman-Rupp Company 2008

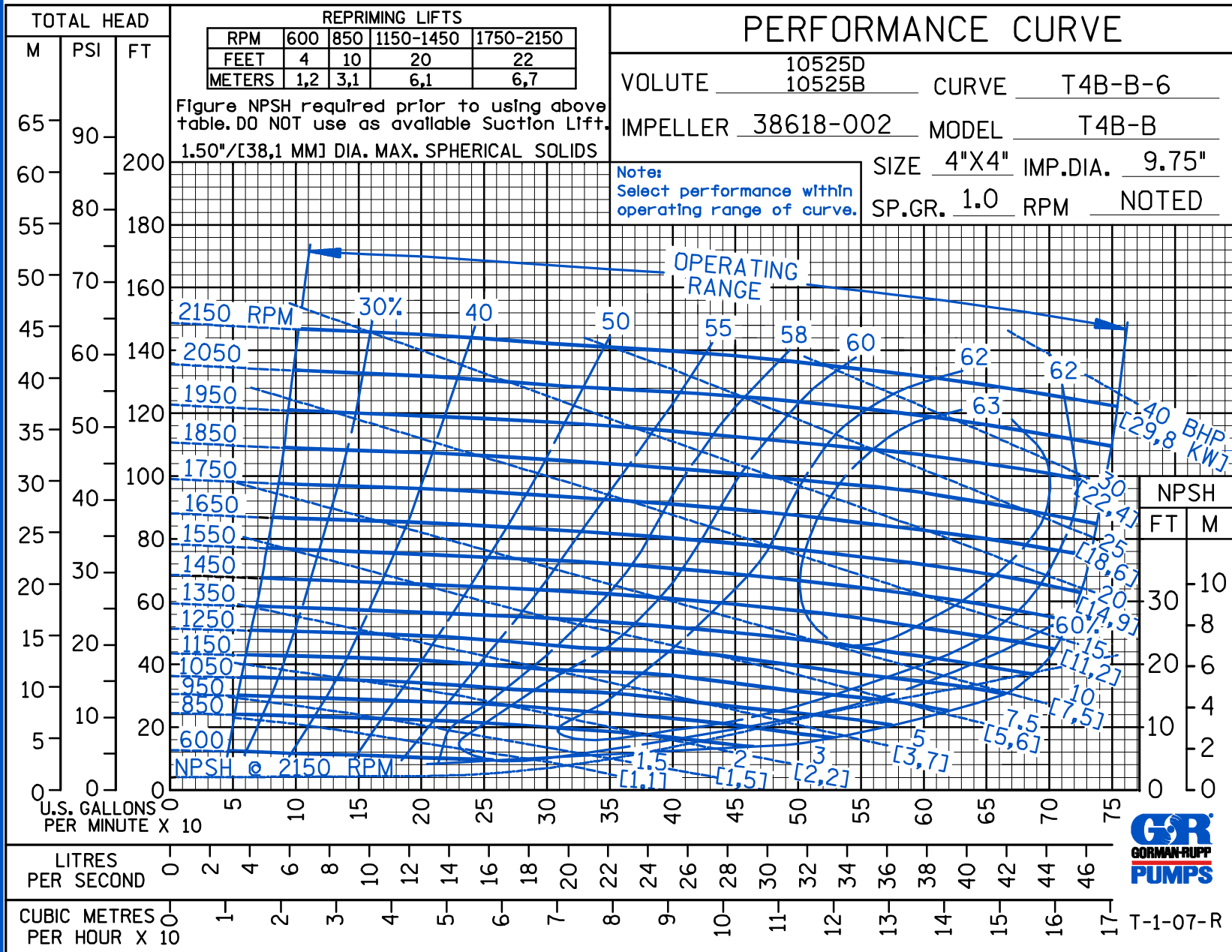

Curve Data

Sec. 55

PAGE 2185.5  
JULY 2008

CDSW



**THE GORMAN-RUPP COMPANY • MANSFIELD, OHIO**  
 GORMAN-RUPP OF CANADA LIMITED • ST. THOMAS, ONTARIO, CANADA  
 www.grpumps.com

© Copyright by the Gorman-Rupp Company 2008

Specifications Subject to Change Without Notice

Printed in U.S.A.

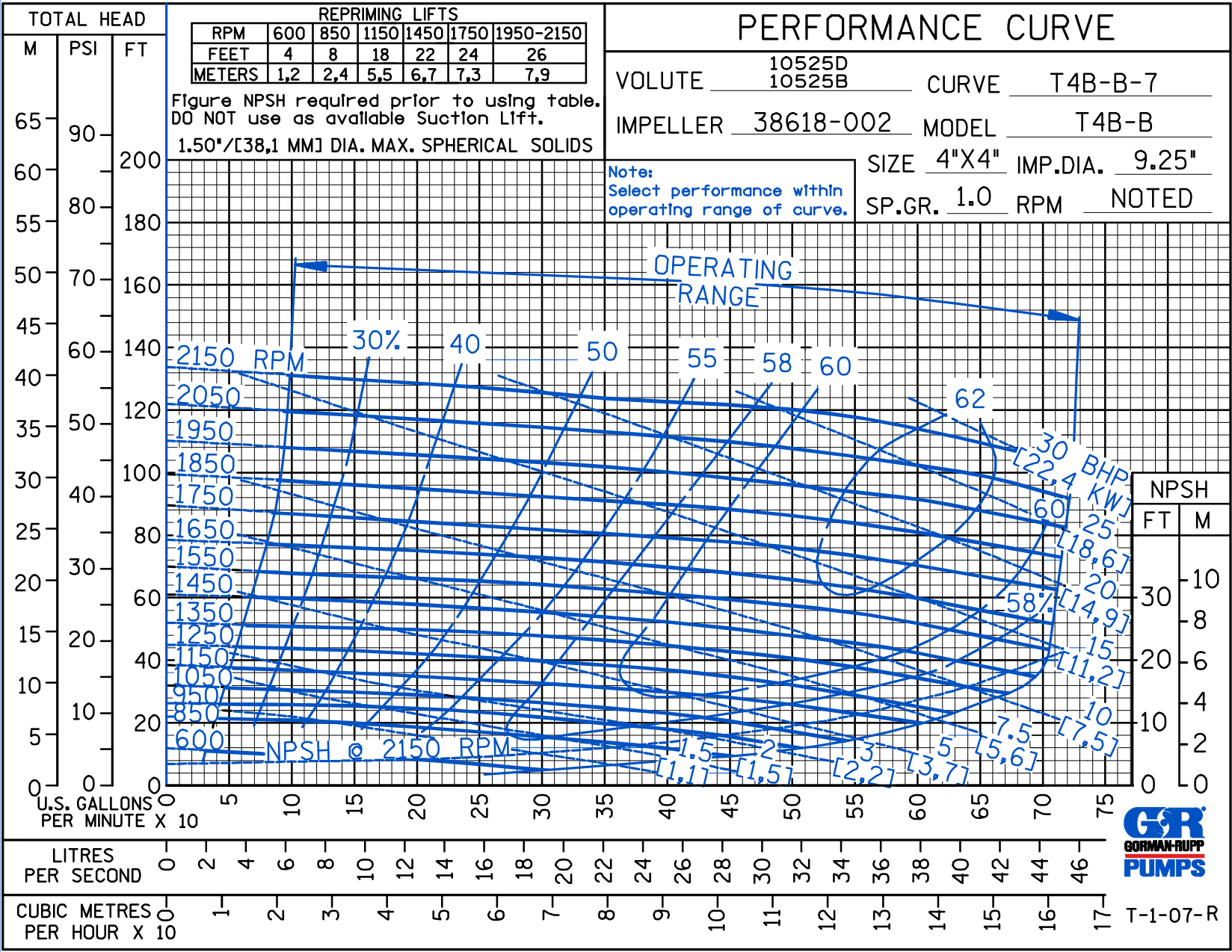

CDSW

Curve Data

Sec. 55

PAGE 2185.6  
JULY 2008





THE GORMAN-RUPP COMPANY • MANSFIELD, OHIO

GORMAN-RUPP OF CANADA LIMITED • ST. THOMAS, ONTARIO, CANADA

www.grpumps.com

Specifications Subject to Change Without Notice

Printed in U.S.A.

© Copyright by the Gorman-Rupp Company 2008

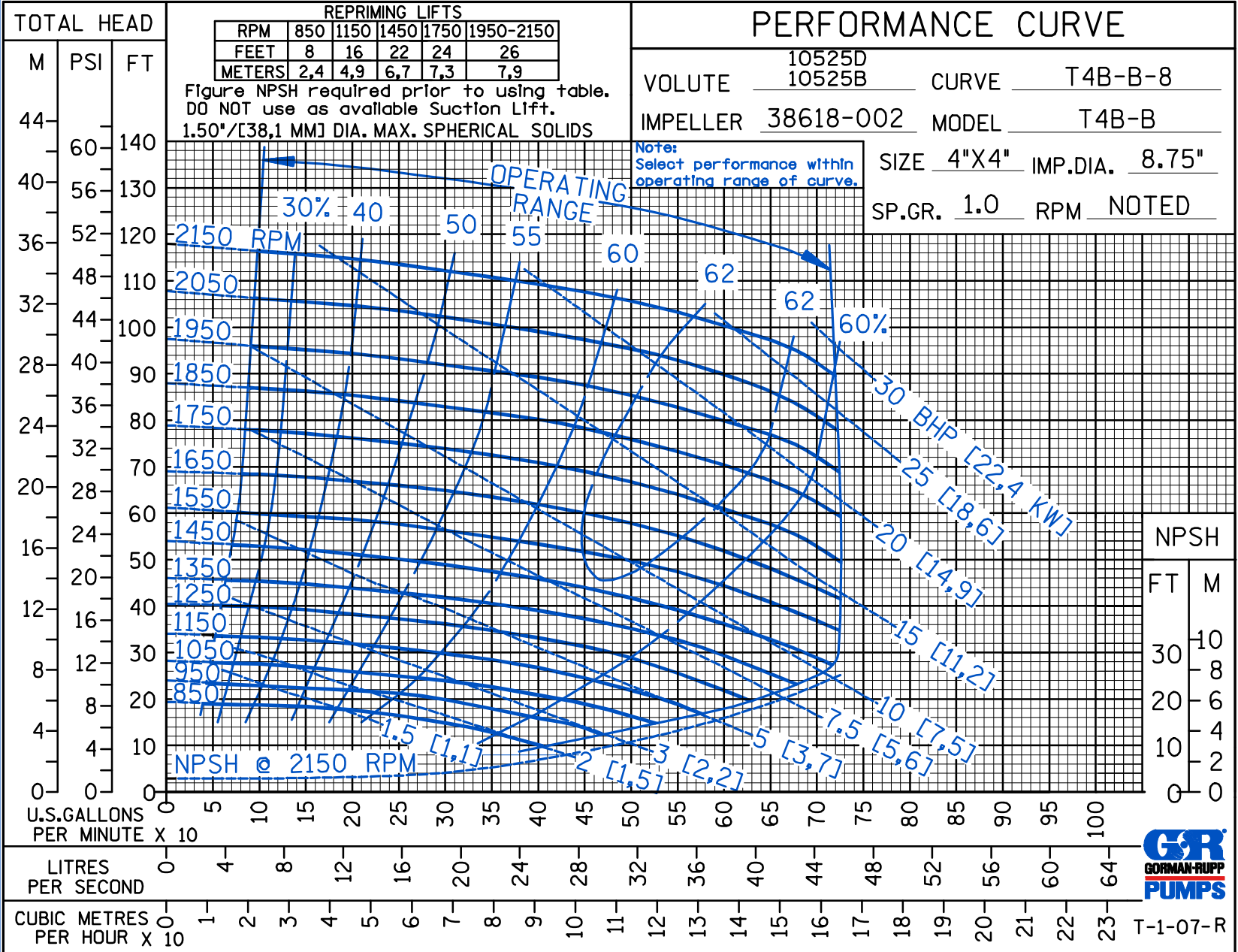

CDSW

Curve Data

Sec. 55

PAGE 2185.7  
JULY 2008



**THE GORMAN-RUPP COMPANY • MANSFIELD, OHIO**  
 GORMAN-RUPP OF CANADA LIMITED • ST. THOMAS, ONTARIO, CANADA  
 www.grpumps.com

© Copyright by the Gorman-Rupp Company 2008

Printed in U.S.A.

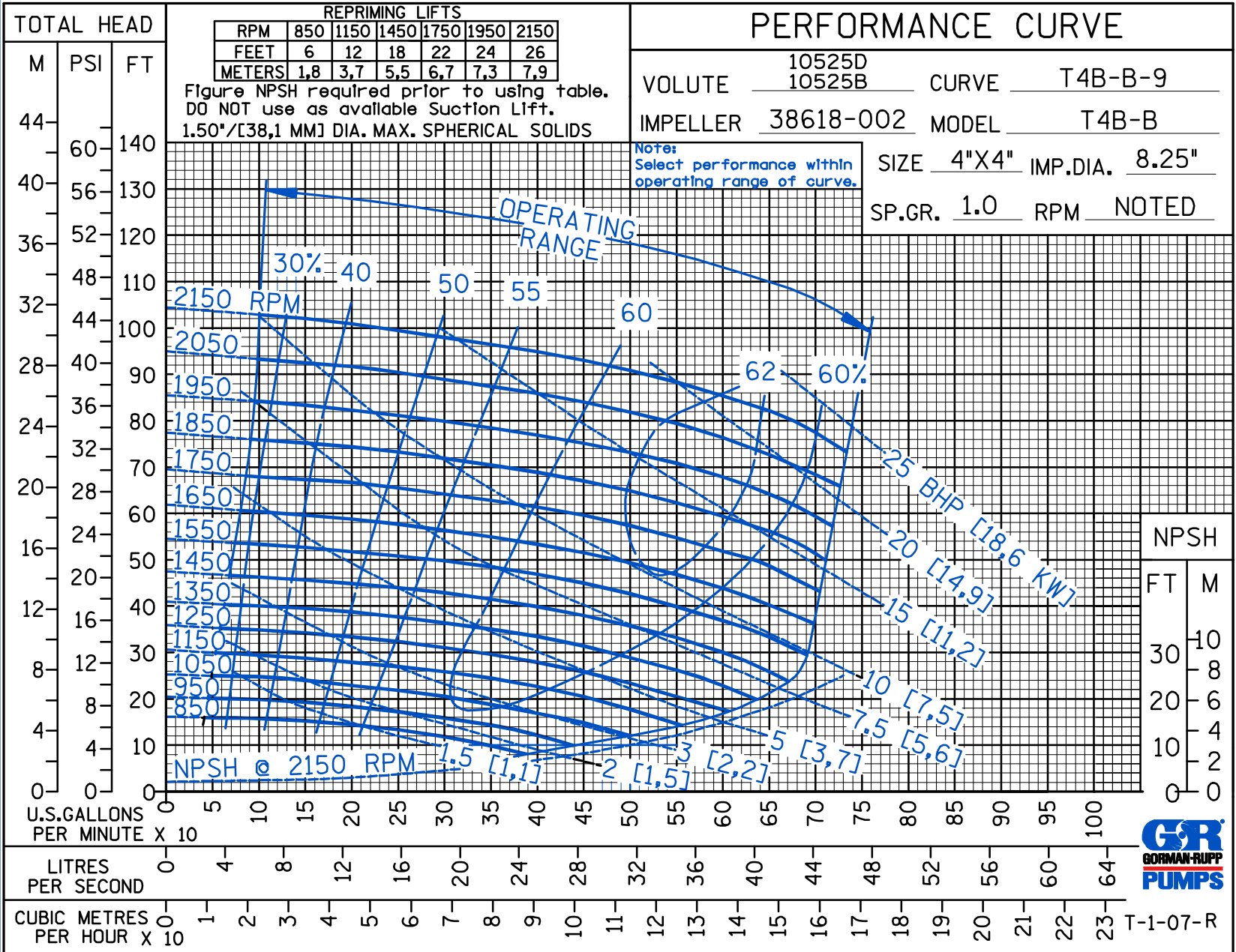

CDSW

Curve Data

Sec. 55

PAGE 2185.8  
JULY 2008



THE GORMAN-RUPP COMPANY • MANSFIELD, OHIO

GORMAN-RUPP OF CANADA LIMITED • ST. THOMAS, ONTARIO, CANADA

www.grpmumps.com

Specifications Subject to Change Without Notice

Printed in U.S.A.

© Copyright by the Gorman-Rupp Company 2008

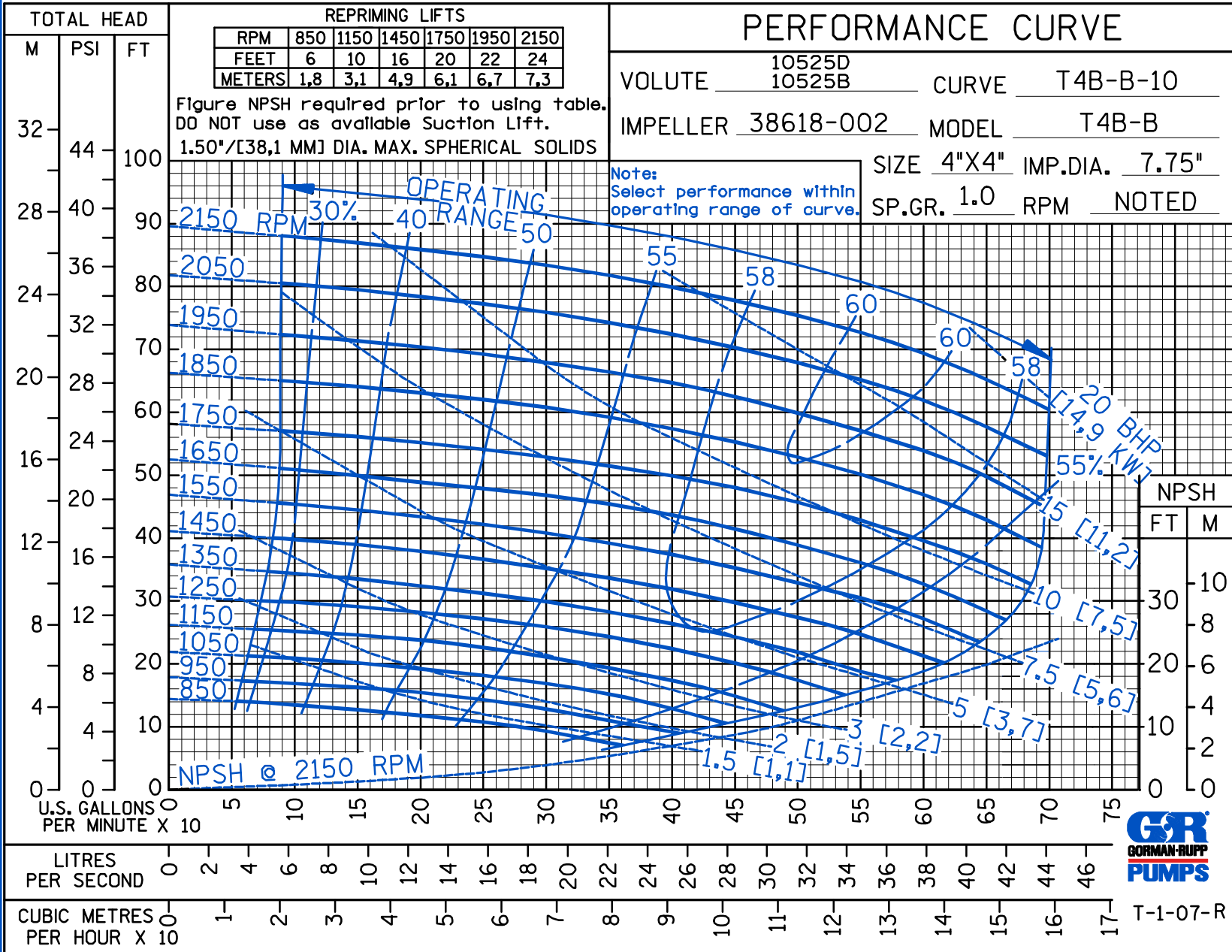

CDSW

Curve Data

Sec. 55

PAGE 2185.9  
JULY 2008



T-1-07-R



**THE GORMAN-RUPP COMPANY • MANSFIELD, OHIO**  
 GORMAN-RUPP OF CANADA LIMITED • ST. THOMAS, ONTARIO, CANADA  
 www.grpumps.com

© Copyright by the Gorman-Rupp Company 2008

Specifications Subject to Change Without Notice

Printed in U.S.A.

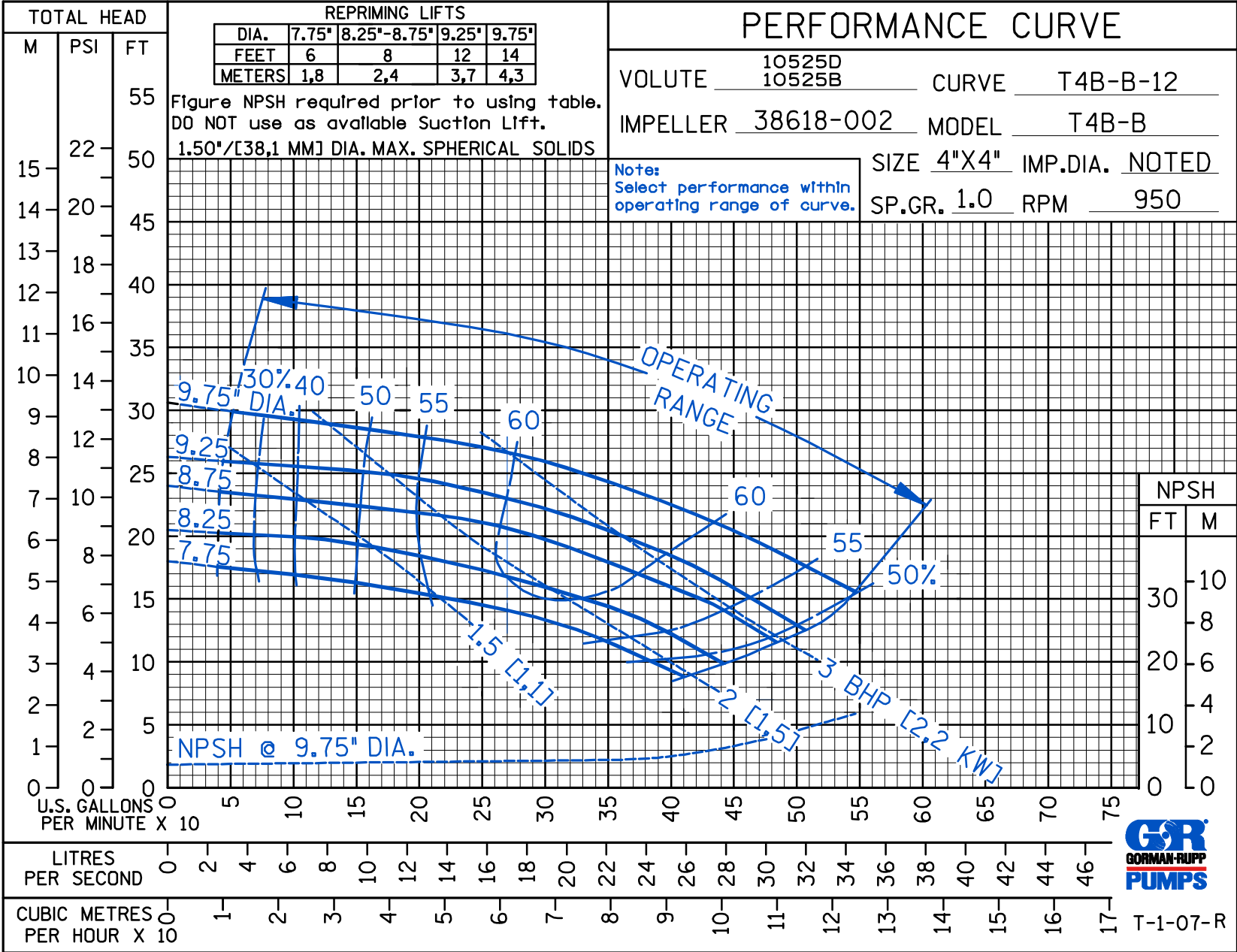

Curve Data

Sec. 55

PAGE 2185.10  
 JULY 2008

D S W

### PERFORMANCE CURVE

VOLUTE 10525D  
10525B CURVE T4B-B-13  
IMPELLER 38618-002 MODEL T4B-B  
SIZE 4"X4" IMP.DIA. 9.75"  
SP.GR. 1.0 RPM NOTED

1.50"/[38,1 MM] DIA. MAX. SPHERICAL SOLIDS  
CURVE FOR PARALLEL APPLICATION ONLY &  
SHOULD NOT BE USED FOR SINGLE PUMP  
PERFORMANCE

NOTE: See single pump curve for  
horsepower, efficiency, & NPSH

2 PUMPS IN PARALLEL

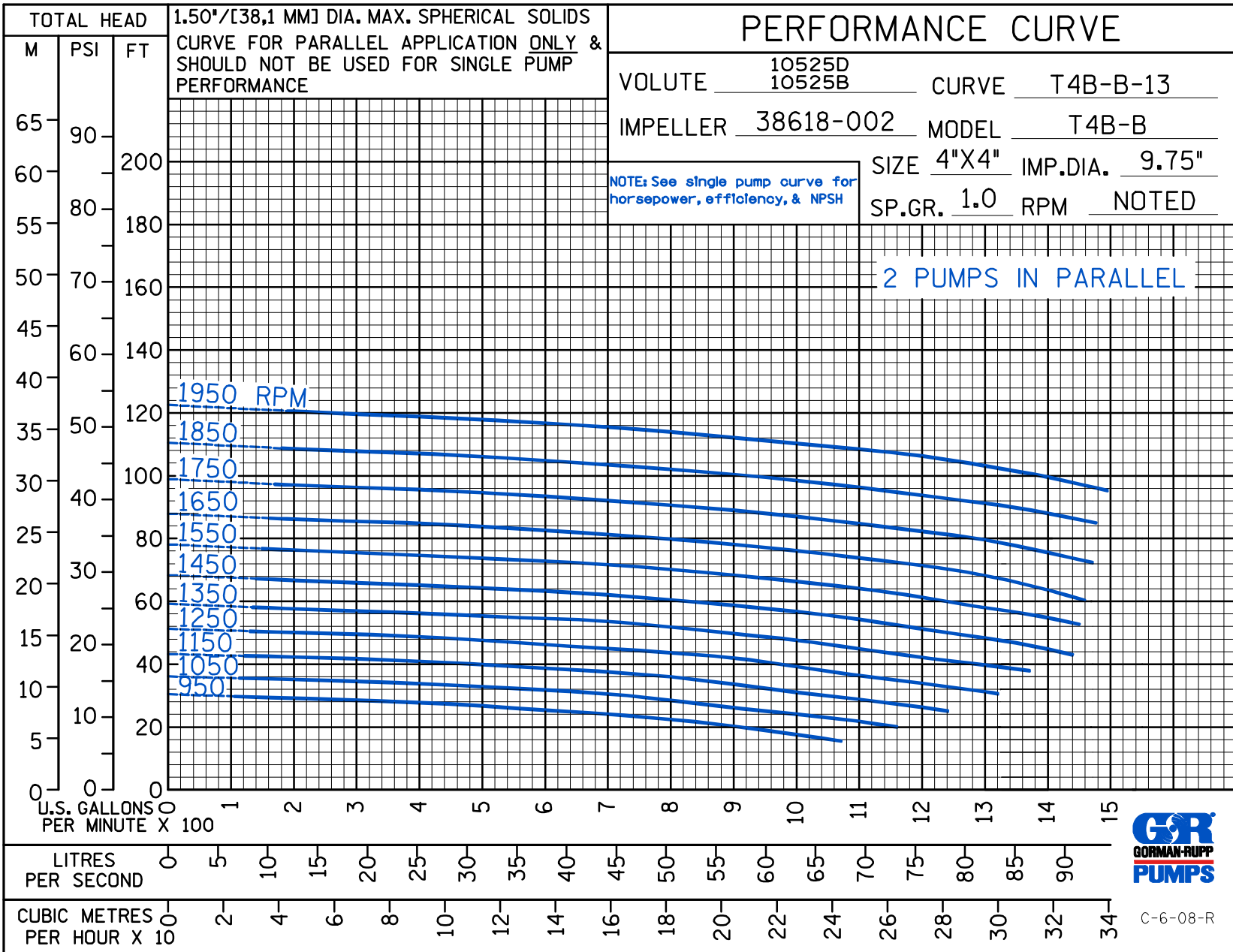

C-6-08-R



THE GORMAN-RUPP COMPANY • MANSFIELD, OHIO

GORMAN-RUPP OF CANADA LIMITED • ST. THOMAS, ONTARIO, CANADA

www.grpumps.com

Specifications Subject to Change Without Notice

Printed in U.S.A.

D S W

# PERFORMANCE CURVE

VOLUTE 10525D CURVE T4B-B-14  
10525B

IMPELLER 38618-002 MODEL T4B-B

Performance shown does not include any interconnecting piping

SIZE 4"X4" IMP.DIA. 9.75"

SP.GR. 1.0 RPM NOTED

NOTE: Series operation is limited by the operating pressure & NPSH requirement of a single pump. See single pump curve for NPSH, EFF., & HP.

2 PUMPS IN SERIES

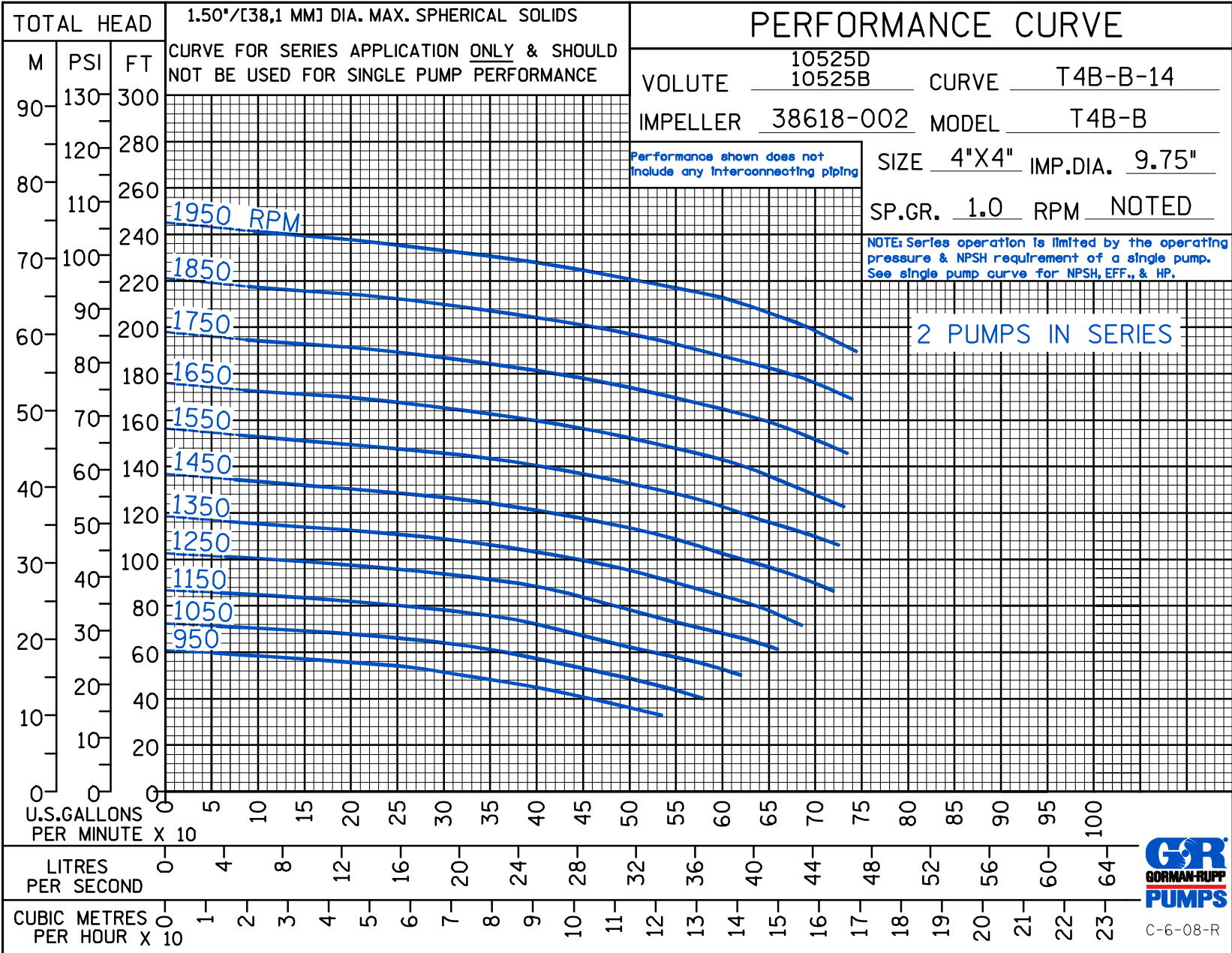

C-6-08-R



**THE GORMAN-RUPP COMPANY • MANSFIELD, OHIO**  
 GORMAN-RUPP OF CANADA LIMITED • ST. THOMAS, ONTARIO, CANADA  
 www.grpumps.com

Specifications Subject to Change Without Notice

Printed in U.S.A.