

Basic Pump

DS

Self Priming Centrifugal Pump

Super
TSERIES

VARIOUS PATENTS APPLY

Model T3A3S-B

Size 3" x 3"



PUMP SPECIFICATIONS

Size: 3" x 3" (76 mm x 76 mm) NPT - Female.**Casing:** Gray Iron 30.

Maximum Operating Pressure 86 psi (593 kPa).*

Semi-Open Type, Two Vane Impeller: Ductile Iron 65-45-12.

Handles 2 1/2" (63,5 mm) Diameter Spherical Solids.

Impeller Shaft: Alloy Steel 4150.**Shaft Sleeve:** Alloy Steel 4130.**Replaceable Wear Plate:** Carbon Steel 1015.**Removable Adjustable Cover Plate:** Gray Iron 30; 35 lbs. (16 kg)**Seal Plate:** Gray Iron 30.**Flap Valve:** Neoprene ^{w/}Nylon and Steel Reinforcing.**Bearing Housing:** Gray Iron 30.**Radial and Thrust Bearings:** Open Single Row Ball.**Bearing and Seal Cavity Lubrication:** SAE 30 Non-Detergent Oil.**Flanges:** 125# Gray Iron 30.**Gaskets:** Buna-N ^{w/}Compressed Synthetic Fibers, Vegetable Fiber, PTFE, Cork and Rubber.**O-Rings:** Buna-N.**Hardware:** Standard Plated Steel.**Brass Pressure Relief Valve.****Bearing and Seal Cavity Oil Level Sight Gauges.****Optional Equipment:** Automatic Air Release Valve. Metal

Bellows Seal. 120V/240V Casing Heater. High Pump

Temperature Shutdown Kit. G-R Hard Iron Casing.

Self-Cleaning Wear Plate.

Gray Iron 30 Suction and Discharge Spool Flanges:

3" ASA (**Specify Model T3A3S-B /F**).80 mm DIN 2527 (PN 16) (**Specify Model T3A3S-B /FM**).

*Consult Factory for Applications Exceeding Maximum Pressure and/or Temperature Indicated.



Shown with Optional Suction and Discharge Spool Flanges (Available in ASA or DIN Standard Sizes).

SEAL SPECIFICATIONS

Cartridge Type, Mechanical, Oil-Lubricated, Double Floating, Self-Aligning. Tungsten Titanium Carbide Rotating and Stationary Faces. Stainless Steel 316 Stationary Seat. Fluorocarbon Elastomers (DuPont Viton[®] or Equivalent). Stainless Steel 18-8 Cage and Spring. Maximum Temperature of Liquid Pumped, 160°F (71°C).*

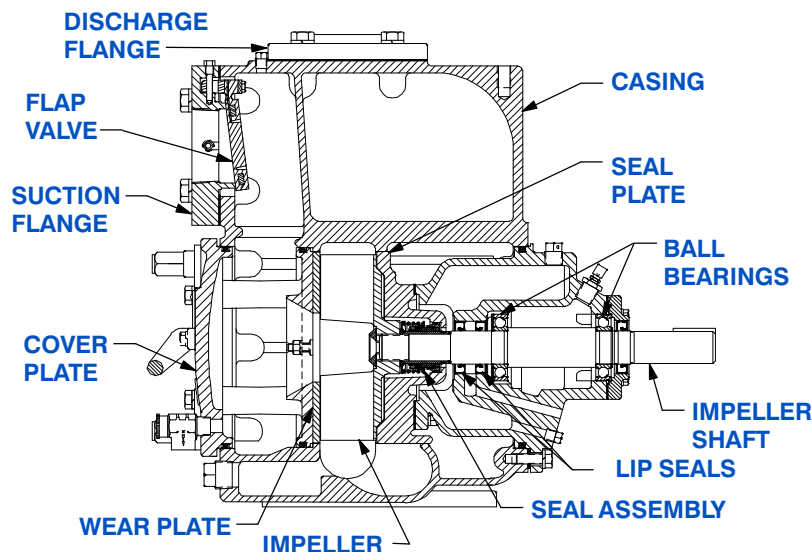

SEAL DETAIL

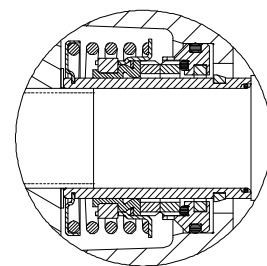

THE GORMAN-RUPP COMPANY • MANSFIELD, OHIO

GORMAN-RUPP OF CANADA LIMITED • ST. THOMAS, ONTARIO, CANADA

www.grpumps.com

Specifications Subject to Change Without Notice

Printed in U.S.A.

Specification Data

SECTION 55, PAGE 2000

APPROXIMATE DIMENSIONS and WEIGHTS

NET WEIGHT: 404 LBS. (183 KG.)*
SHIPPING WEIGHT: 452 LBS. (205 KG.)*
EXPORT CRATE: 19.3 CU. FT. (0,55 CU. M.)
***ADD 10 LBS. (4,5 KG.) W/EACH SPOOL FLANGE**

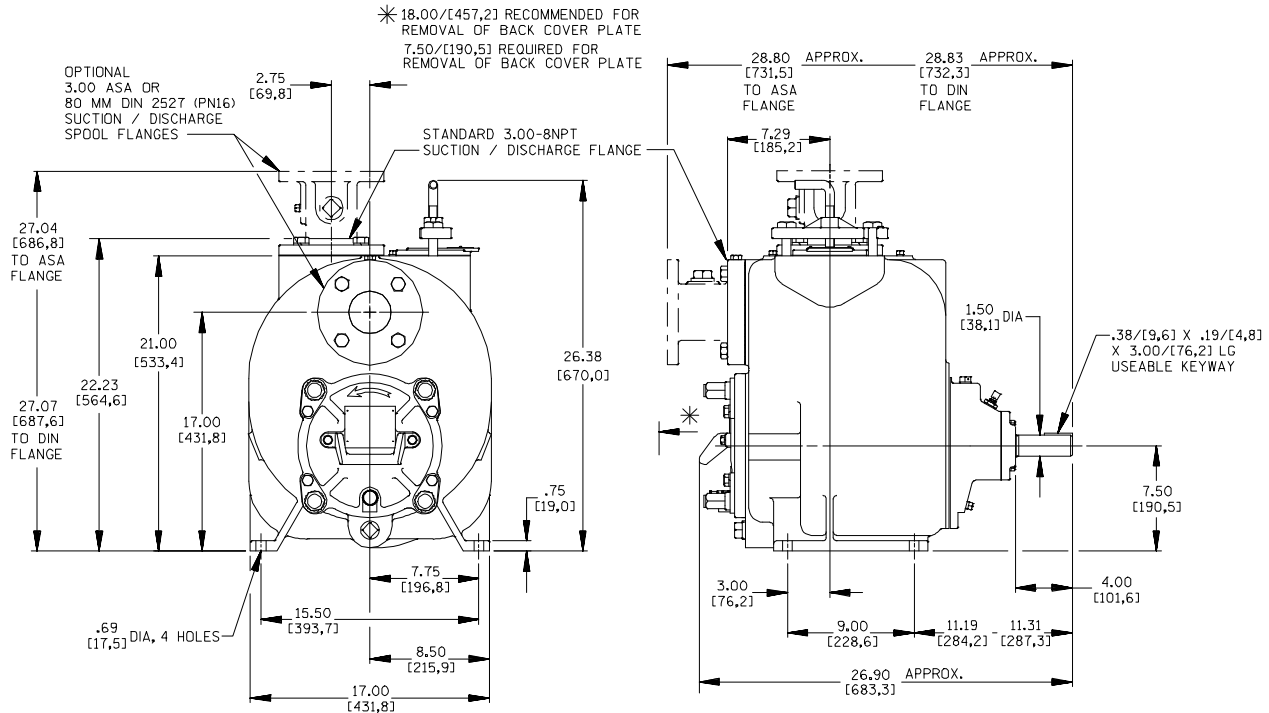

OPTIONAL ASA OR DIN STANDARD SUCTION & DISCHARGE SPOOL FLANGES AVAILABLE

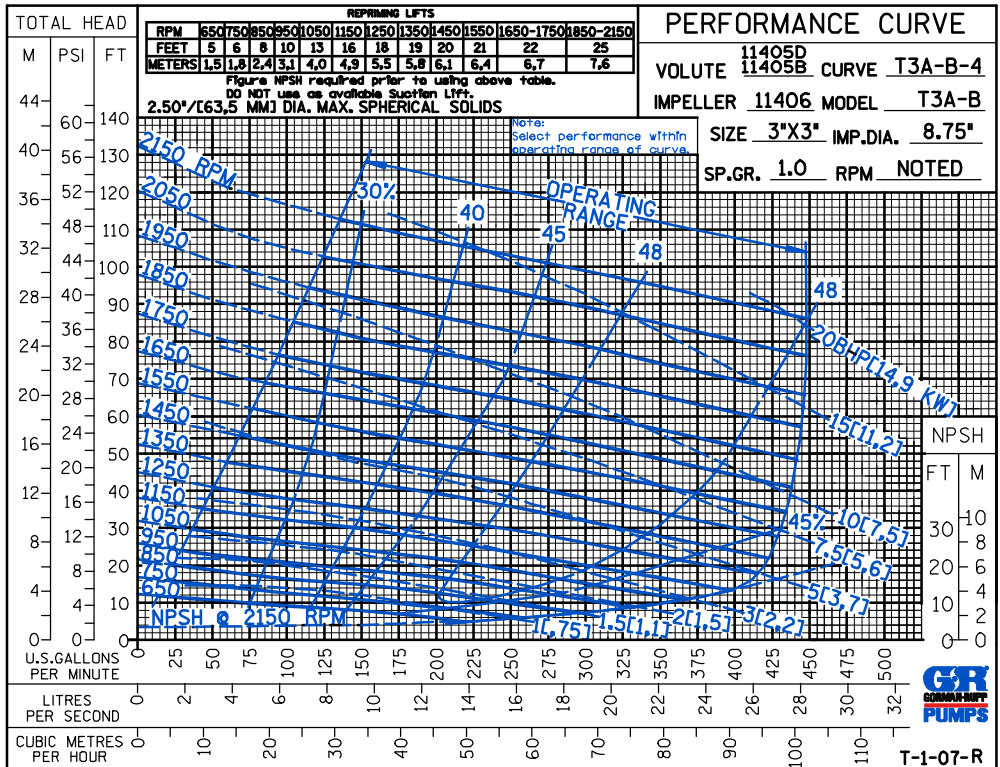

T3AS-B



THE GORMAN-RUPP COMPANY • MANSFIELD, OHIO

GORMAN-RUPP OF CANADA LIMITED • ST. THOMAS, ONTARIO, CANADA

Specifications Subject to Change Without Notice

Printed in U.S.A.



THE GORMAN-RUPP COMPANY • MANSFIELD, OHIO
 GORMAN-RUPP OF CANADA LIMITED • ST. THOMAS, ONTARIO, CANADA
 www.grpumps.com

Specifications Subject to Change Without Notice

Printed in U.S.A.

© Copyright by the Gorman-Rupp Company 2008

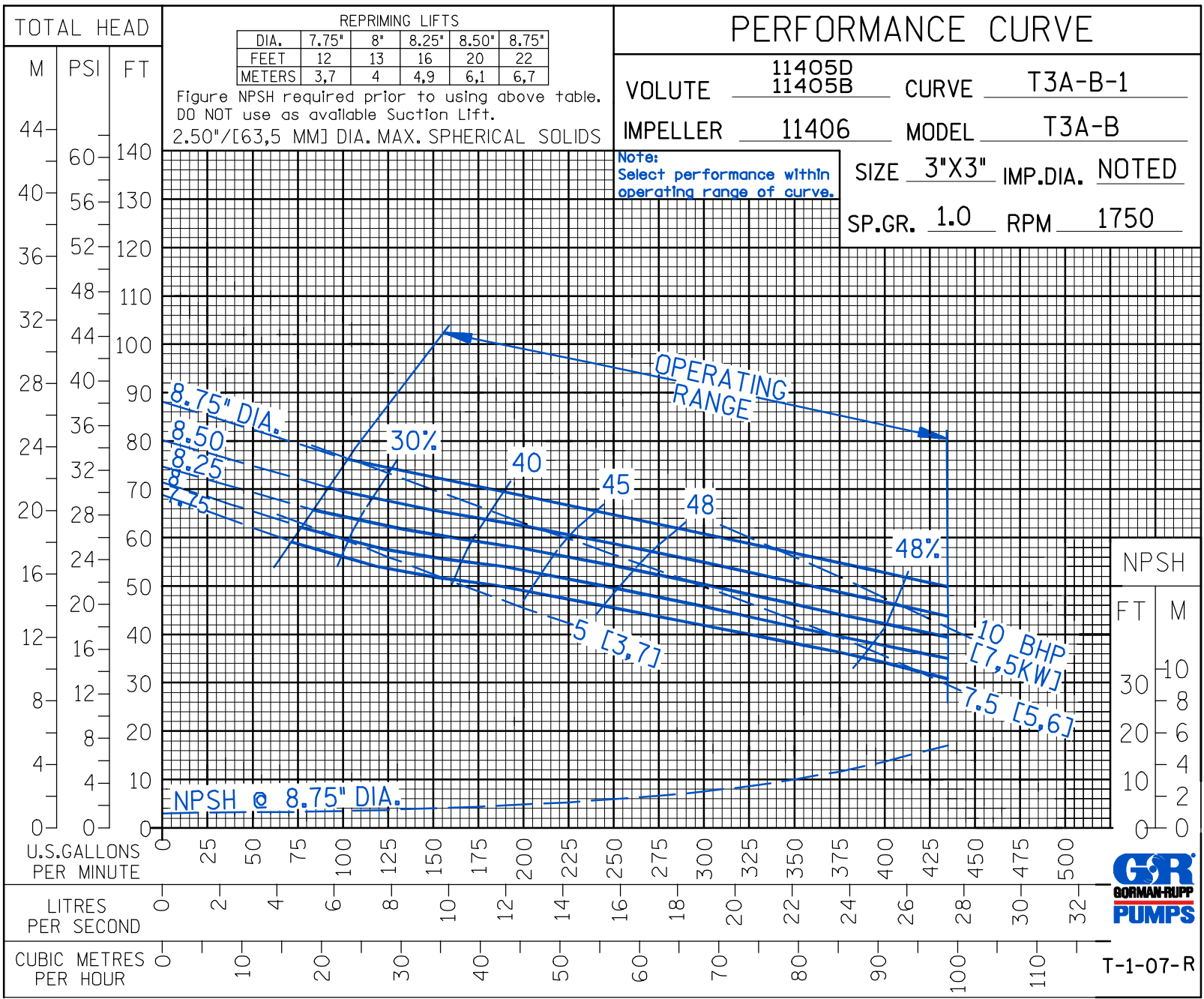

Curve Data
CDSW

Sec. 55
PAGE 2051.1
JULY 2008



T-1-07-R

CDSW

PERFORMANCE CURVE

VOLUTE 11405D
11405B CURVE T3A-B-2
IMPELLER 11406 MODEL T3A-B
SIZE 3"X3" IMP.DIA. NOTED
SP.GR. 1.0 RPM 1150

Note:
Select performance within
operating range of curve.

REPRIMING LIFTS					
DIA.	7.75"	8"	8.25"	8.50"	8.75"
FEET	8	8	9	12	16
METERS	2,4	2,4	2,7	3,7	4,9

Figure NPSH required prior to using above table.
DO NOT use as available Suction Lift.
2.50"/[63,5 MM] DIA. MAX. SPHERICAL SOLIDS

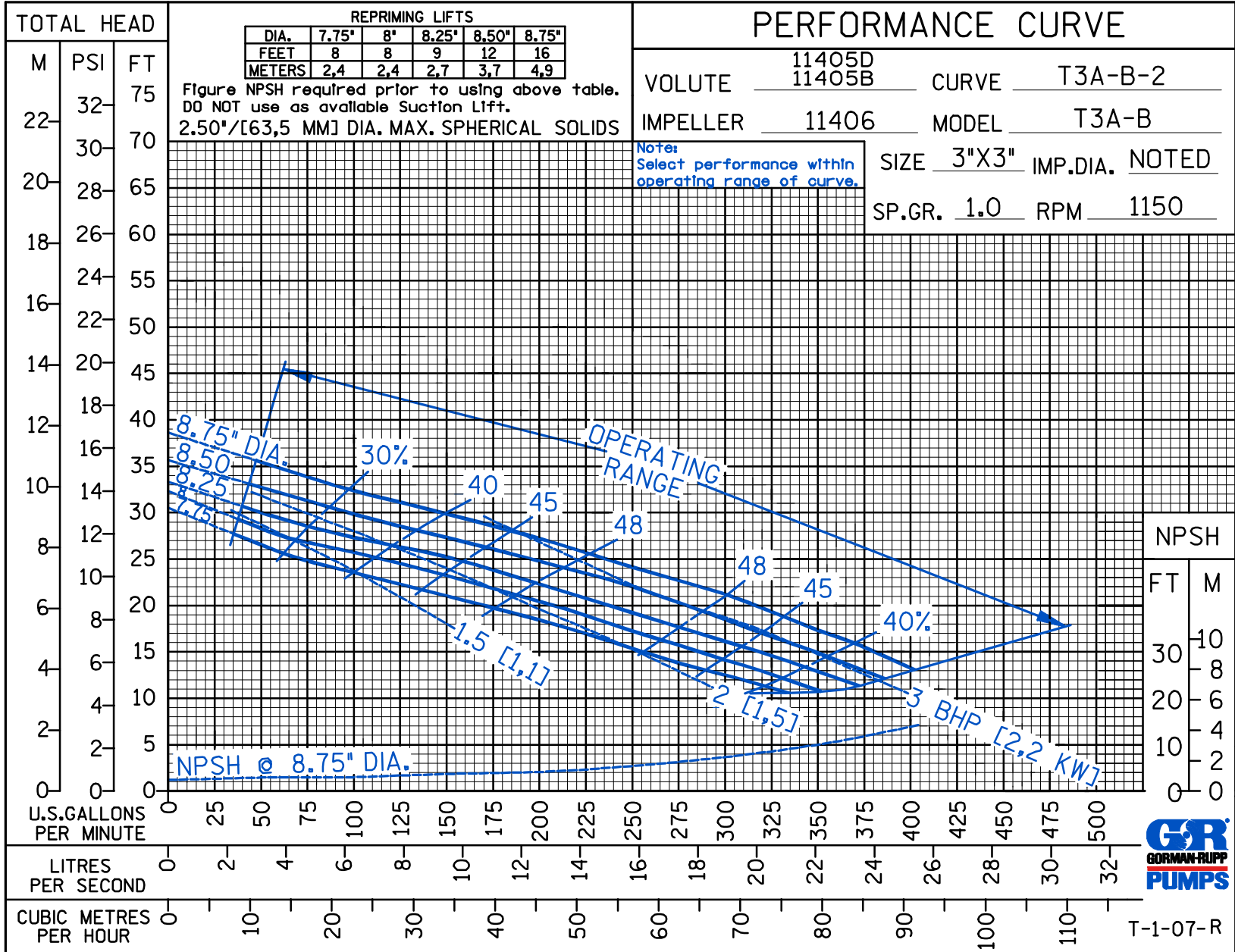

T-1-07-R



THE GORMAN-RUPP COMPANY • MANSFIELD, OHIO
GORMAN-RUPP OF CANADA LIMITED • ST. THOMAS, ONTARIO, CANADA

www.grpumps.com
Specifications Subject to Change Without Notice

Printed in U.S.A.



THE GORMAN-RUPP COMPANY • MANSFIELD, OHIO

GORMAN-RUPP OF CANADA LIMITED • ST. THOMAS, ONTARIO, CANADA

www.grpumps.com

Specifications Subject to Change Without Notice

Printed in U.S.A.

© Copyright by the Gorman-Rupp Company 2008

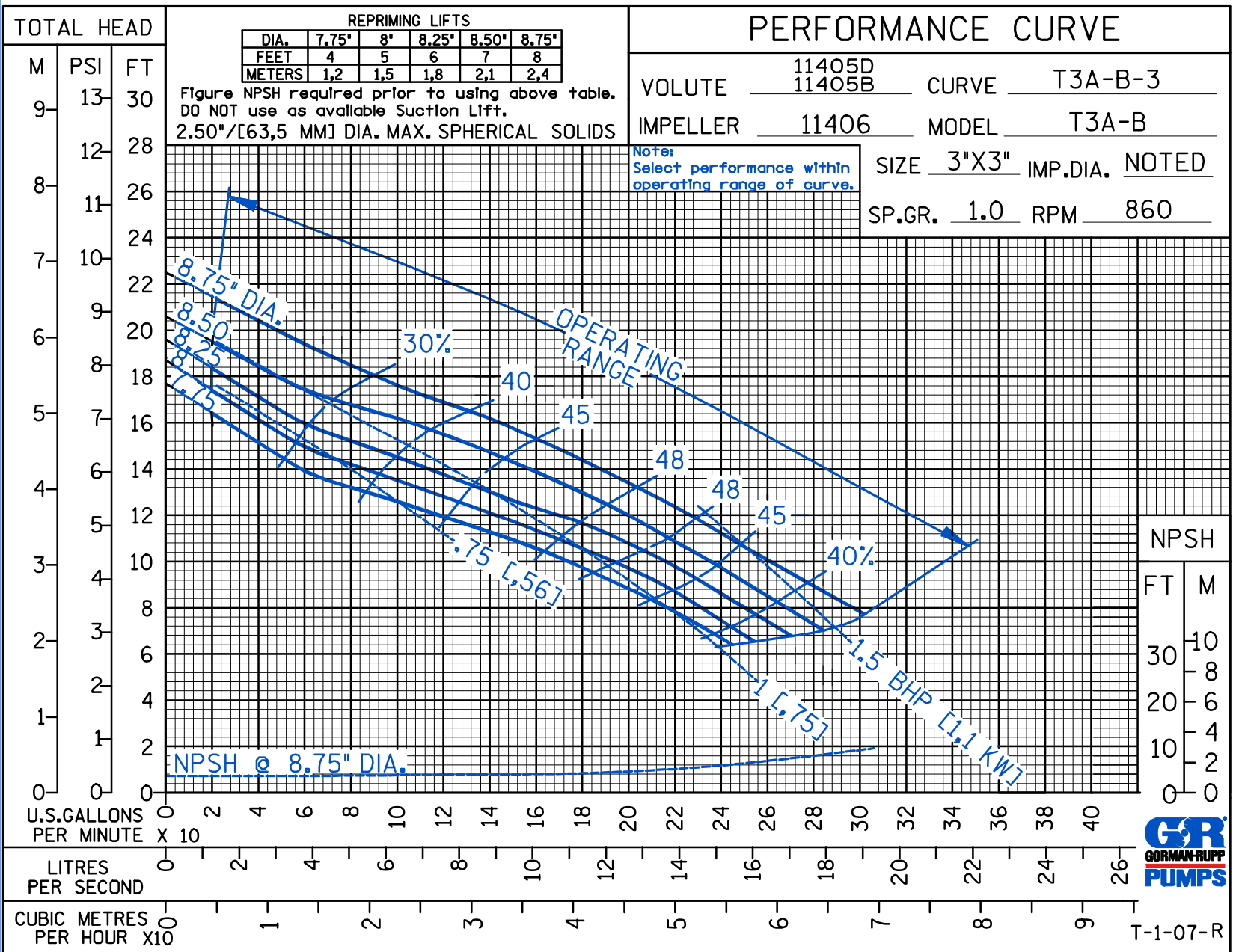

Curve Data

Sec. 55

PAGE 2051.3
JULY 2008



THE GORMAN-RUPP COMPANY • MANSFIELD, OHIO
 GORMAN-RUPP OF CANADA LIMITED • ST. THOMAS, ONTARIO, CANADA
 www.grpumps.com

© Copyright by the Gorman-Rupp Company 2008

Specifications Subject to Change Without Notice

Printed in U.S.A.

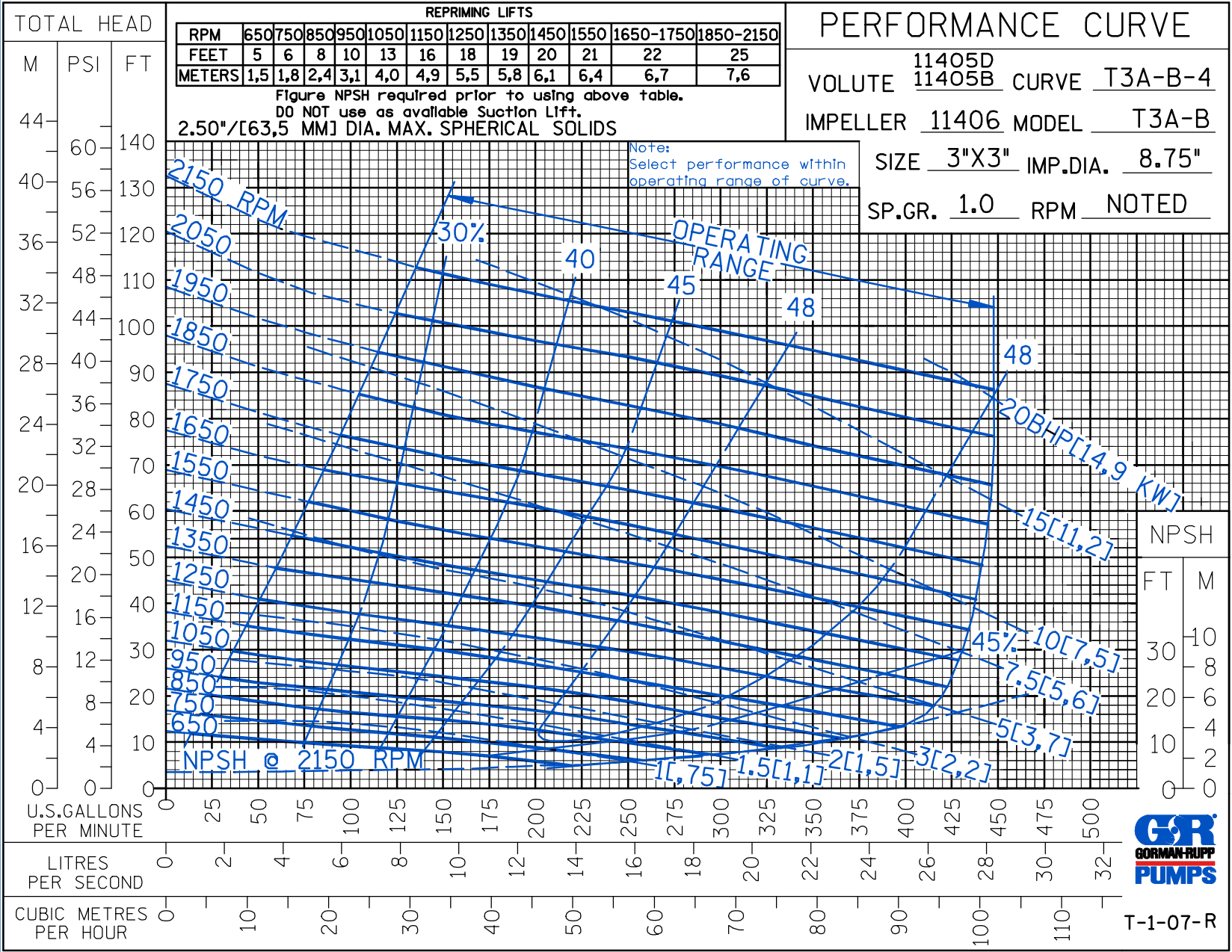

CDSW

Curve Data

Sec. 55

PAGE 2051.4
 JULY 2008



T-1-07-R



THE GORMAN-RUPP COMPANY • MANSFIELD, OHIO

GORMAN-RUPP OF CANADA LIMITED • ST. THOMAS, ONTARIO, CANADA

www.gorpumps.com

Specifications Subject to Change Without Notice

Printed in U.S.A.

© Copyright by the Gorman-Rupp Company 2008

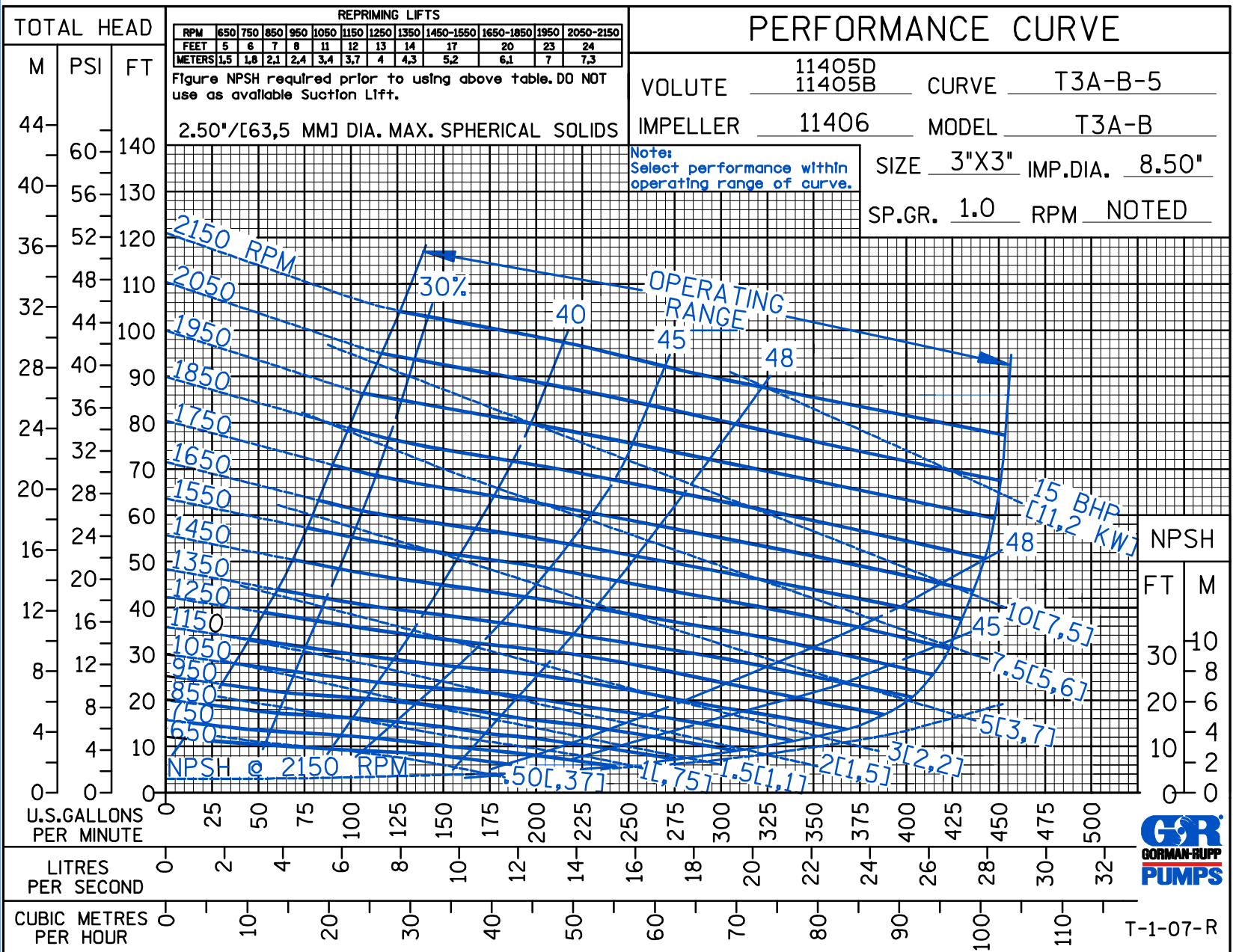

CDSW

Curve Data

Sec. 55

PAGE 2051.5
JULY 2008



THE GORMAN-RUPP COMPANY • MANSFIELD, OHIO

GORMAN-RUPP OF CANADA LIMITED • ST. THOMAS, ONTARIO, CANADA

www.grpumps.com

Specifications Subject to Change Without Notice

Printed in U.S.A.

© Copyright by the Gorman-Rupp Company 2008

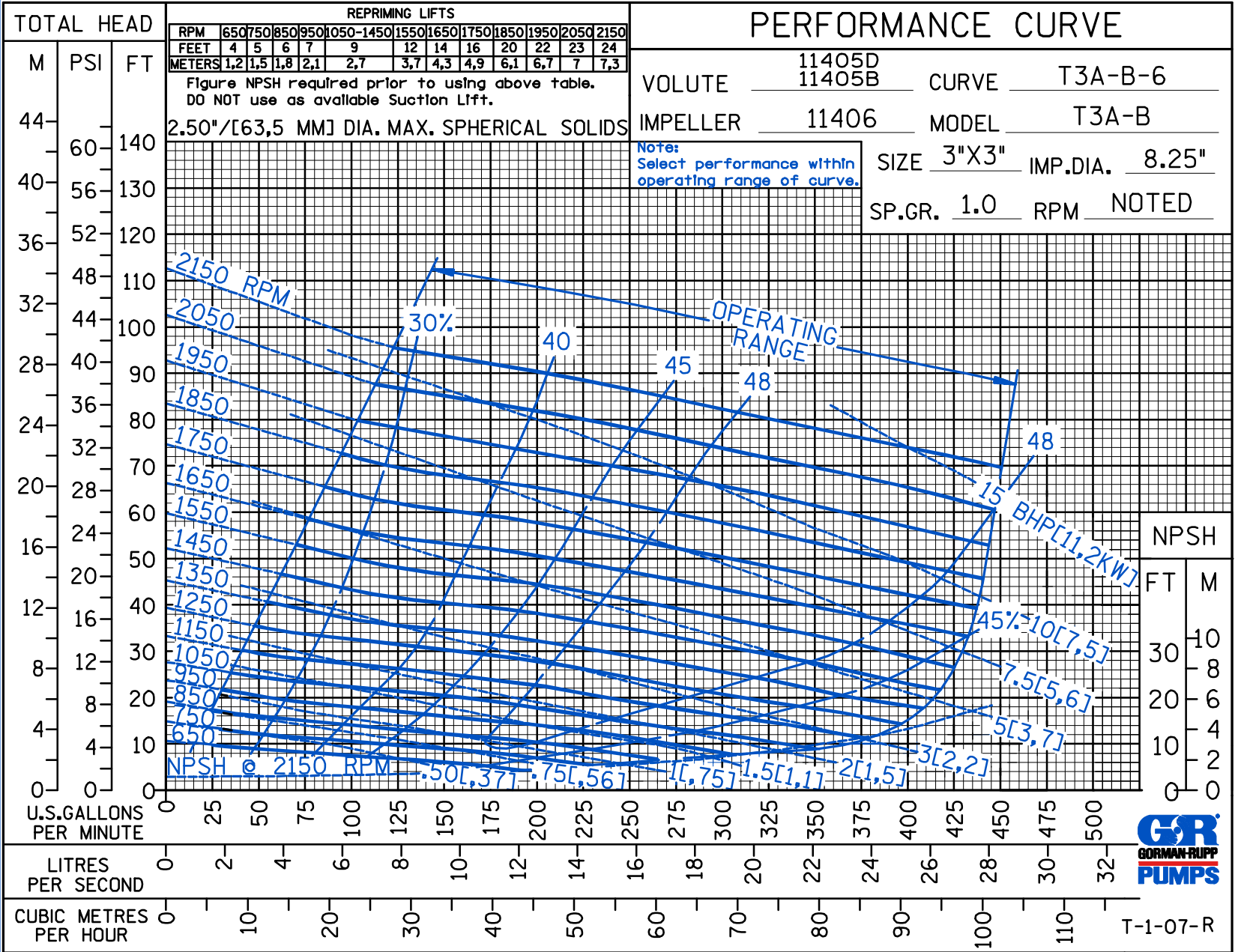



THE GORMAN-RUPP COMPANY • MANSFIELD, OHIO

GORMAN-RUPP OF CANADA LIMITED • ST. THOMAS, ONTARIO, CANADA

www.grpumps.com

Specifications Subject to Change Without Notice

Printed in U.S.A.

© Copyright by the Gorman-Rupp Company 2008

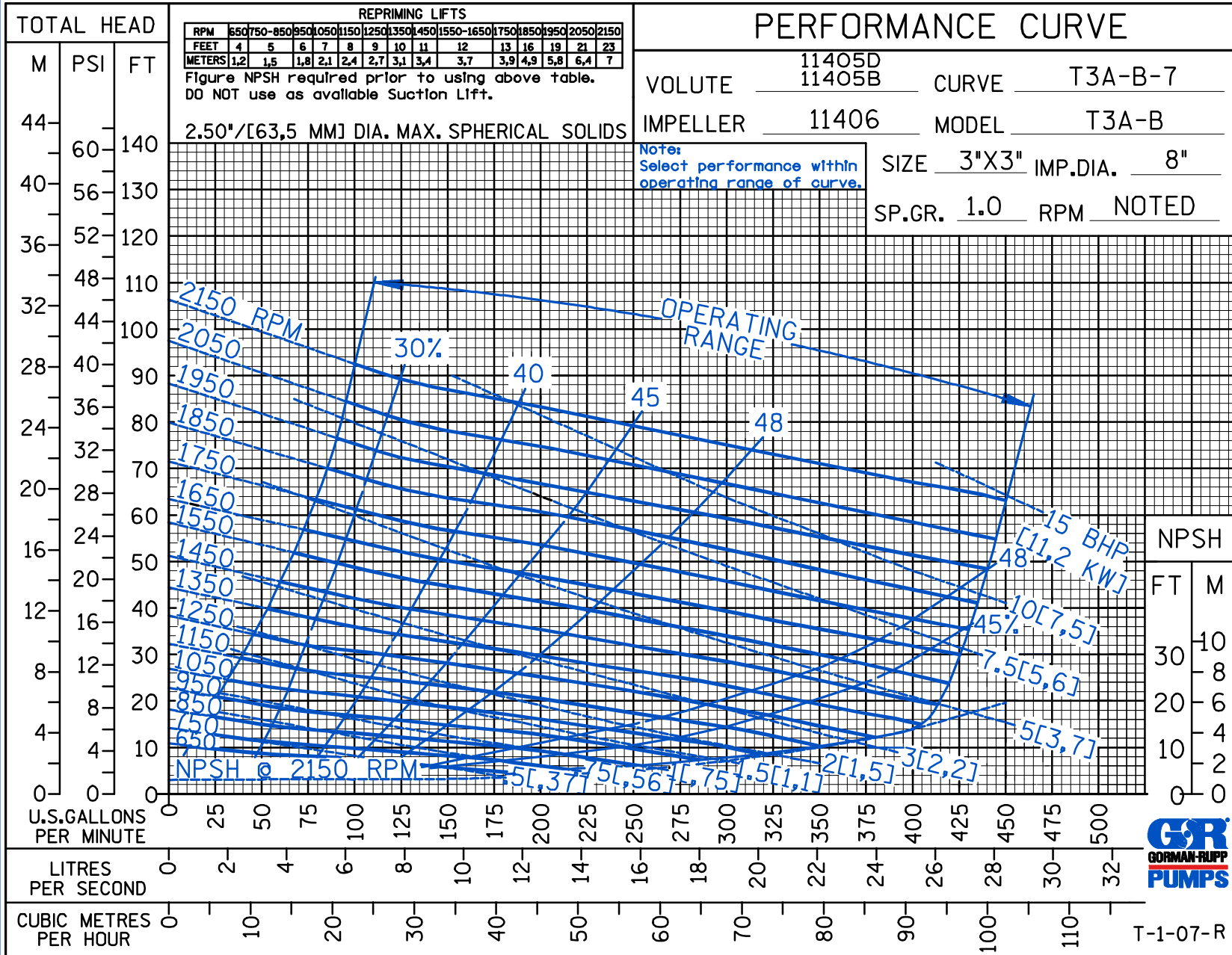

Curve Data

Sec. 55

PAGE 2051.7
JULY 2008

CDSW



T-1-07-R



THE GORMAN-RUPP COMPANY • MANSFIELD, OHIO
 GORMAN-RUPP OF CANADA LIMITED • ST. THOMAS, ONTARIO, CANADA
 www.grpumps.com

© Copyright by the Gorman-Rupp Company 2008

Specifications Subject to Change Without Notice

Printed in U.S.A.

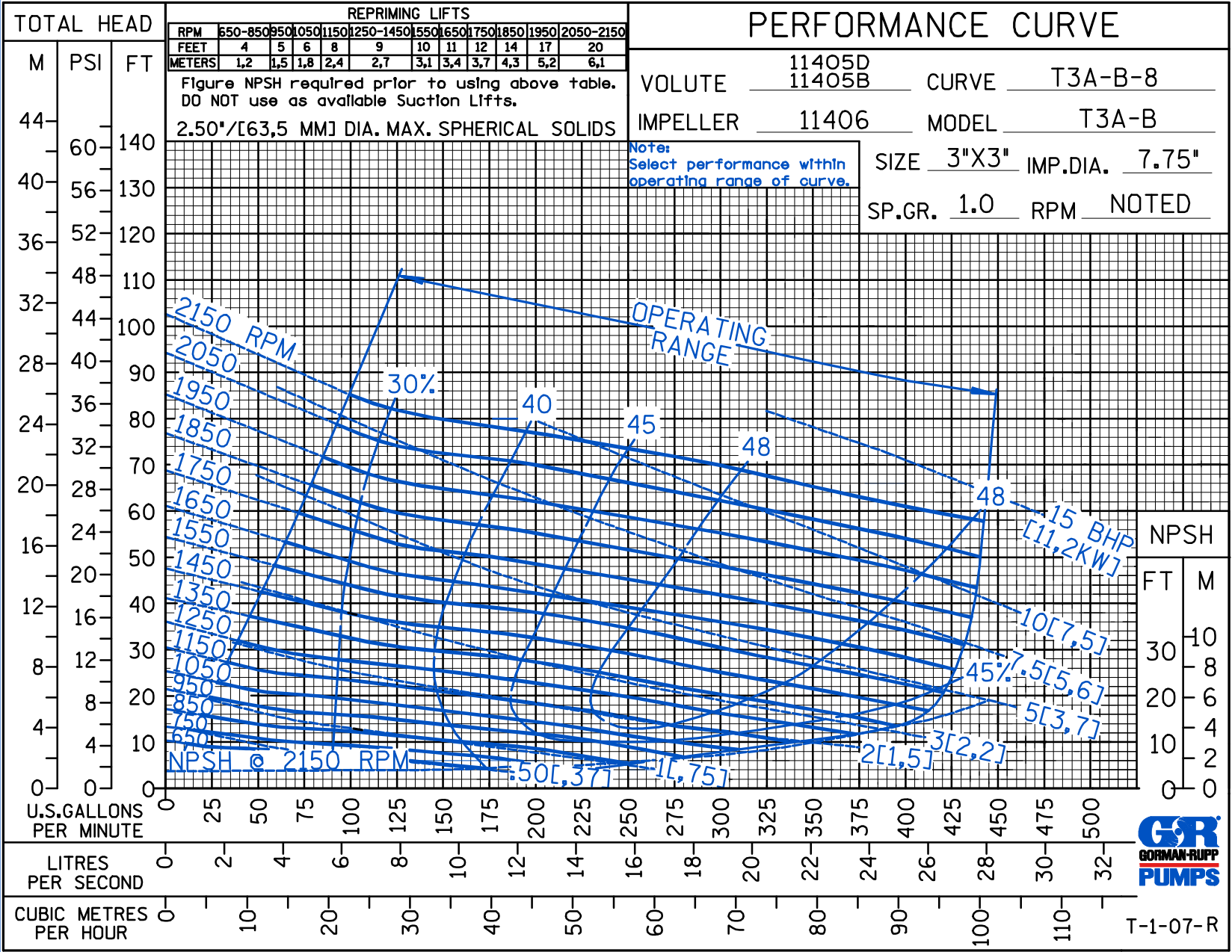

CDSW

Curve Data

Sec. 55

PAGE 2051.8
 JULY 2008

CDSW

NPSH
FT M
30 10
20 8
10 6
0 4
0 2
0 0

PERFORMANCE CURVE

VOLUTE 11405D
11405B

CURVE T3A-B-9

IMPELLER 11406 MODEL T3A-B

SIZE 3"X3" IMP.DIA. NOTED

SP.GR. 1.0 RPM 1450

REPRIMING LIFTS					
DIA.	7.75'	8'	8.25'	8.50'	8.75'
FEET	9	11	9	17	20
METERS	2,7	3,4	2,7	5,2	6,1

Figure NPSH required prior to using above table.
DO NOT use as available Suction Lift.
2.50'/[63,5 MM] DIA. MAX. SPHERICAL SOLIDS

Note:
Select performance within
operating range of curve

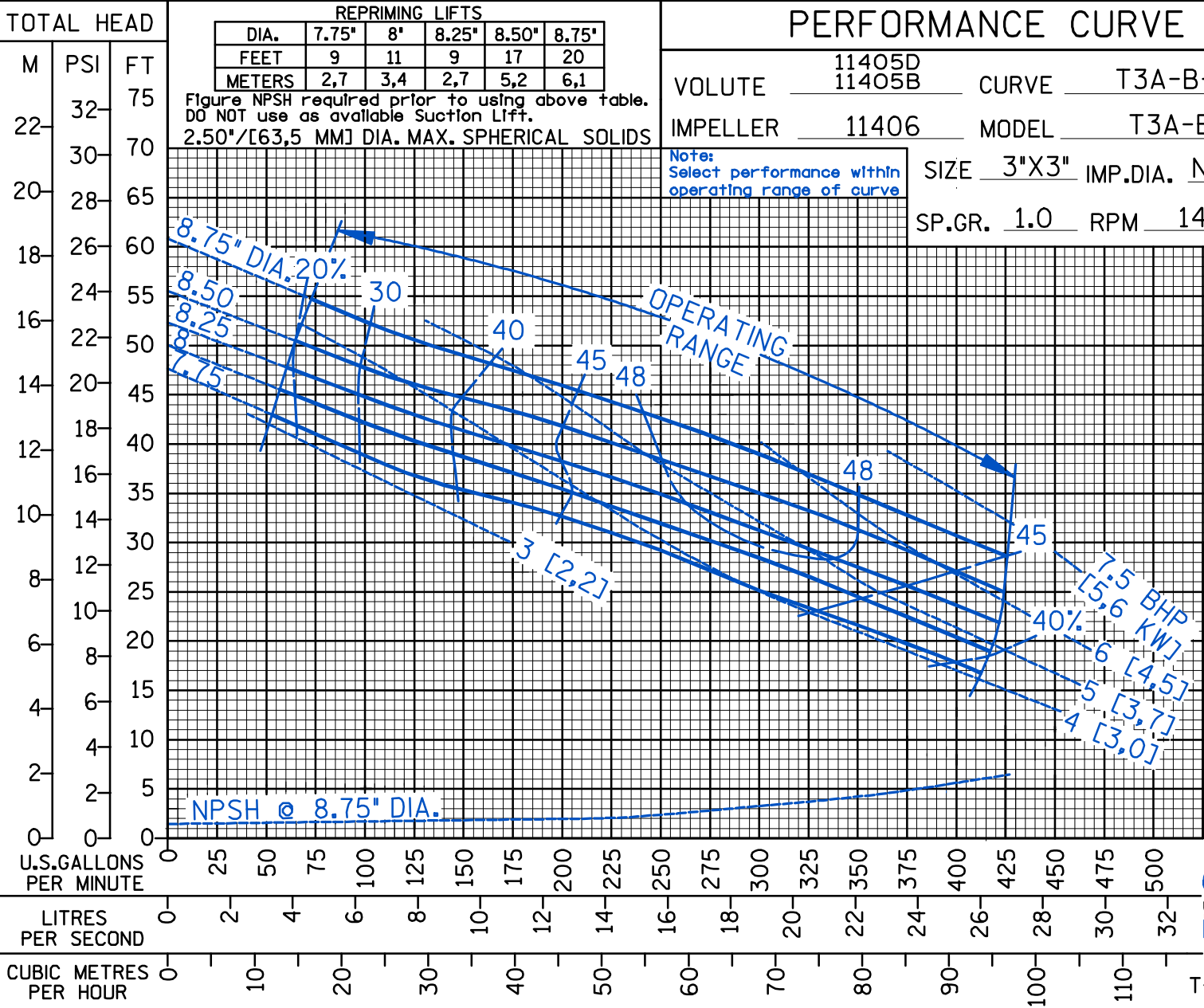

T-1-07-R



THE GORMAN-RUPP COMPANY • MANSFIELD, OHIO

GORMAN-RUPP OF CANADA LIMITED • ST. THOMAS, ONTARIO, CANADA

www.grpmumps.com

Specifications Subject to Change Without Notice

Printed in U.S.A.



THE GORMAN-RUPP COMPANY • MANSFIELD, OHIO
 GORMAN-RUPP OF CANADA LIMITED • ST. THOMAS, ONTARIO, CANADA
 www.grpumps.com
 Specifications Subject to Change Without Notice

© Copyright by the Gorman-Rupp Company 2008

Printed in U.S.A.

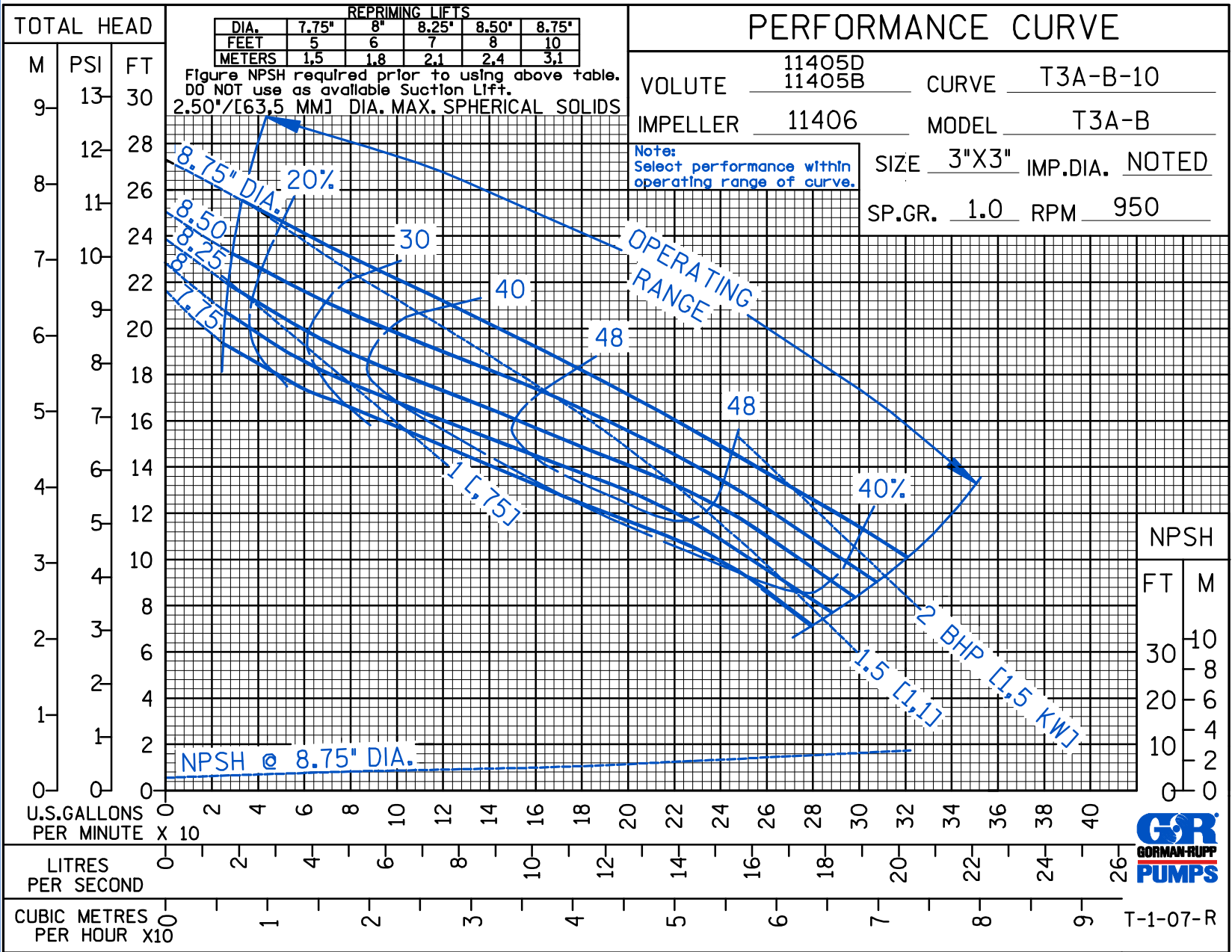

CDSW

Curve Data

Sec. 55

PAGE 2051.10
 JULY 2008

D S W

PERFORMANCE CURVE

VOLUTE	11405D 11405B	CURVE	T3A-B-11
IMPELLER	11406	MODEL	T3A-B
NOTE: See single pump curve for horsepower, efficiency, & NPSH		SIZE	3"X3" IMP.DIA. 8.75"
		SP.GR.	1.0 RPM NOTED

2.50"/[63,5 MM] DIA. MAX. SPHERICAL SOLIDS CURVE FOR PARALLEL APPLICATION ONLY & SHOULD NOT BE USED FOR SINGLE PUMP PERFORMANCE

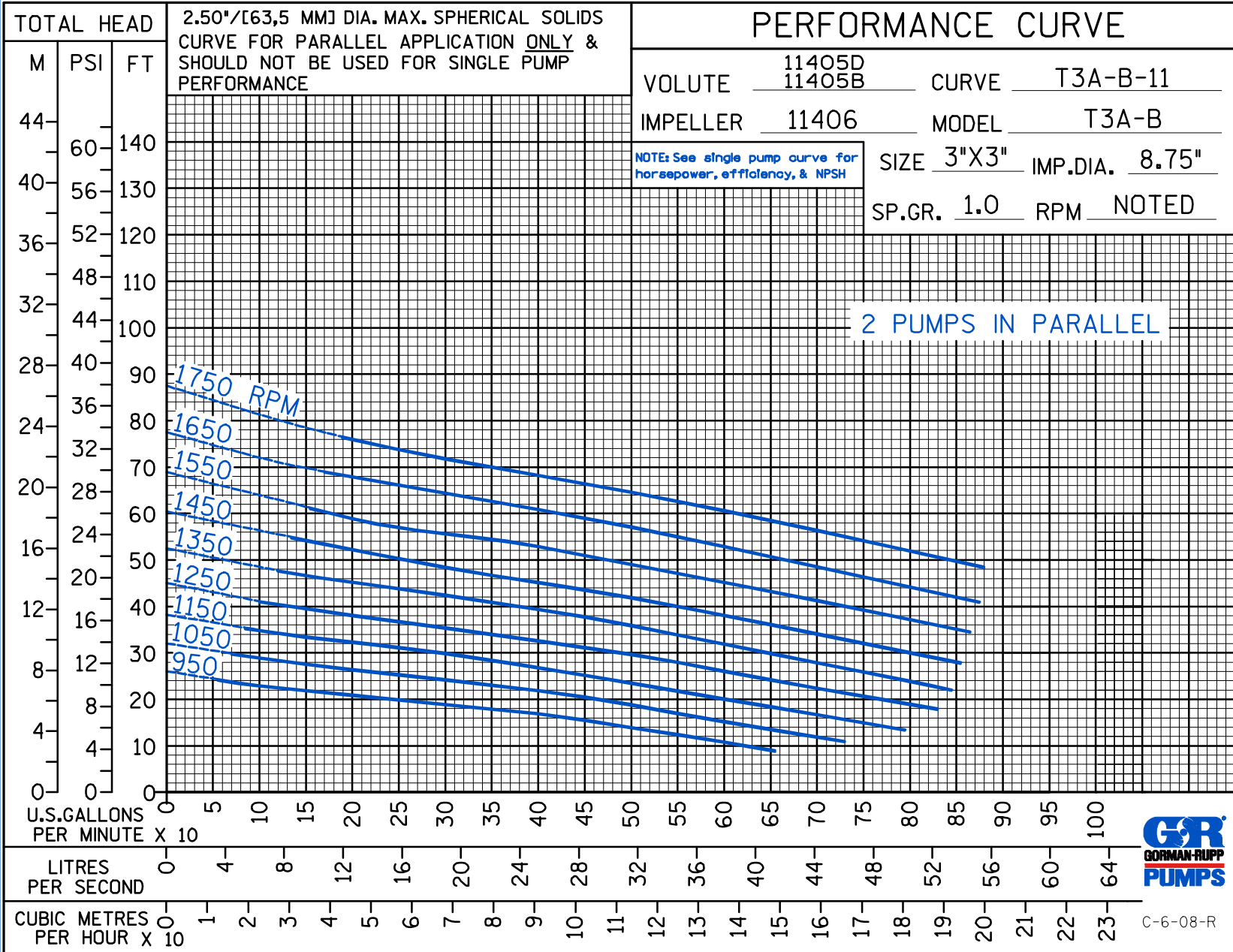

THE GORMAN-RUPP COMPANY • MANSFIELD, OHIO

GORMAN-RUPP OF CANADA LIMITED • ST. THOMAS, ONTARIO, CANADA

www.grpumps.com

Specifications Subject to Change Without Notice

Printed in U.S.A.



C-6-08-R

D S W

PERFORMANCE CURVE

VOLUTE 11405D CURVE T3A-B-12
11405B
 IMPELLER 11406 MODEL T3A-B
 SIZE 3"X3" IMP.DIA. 8.75"
 SP.GR. 1.0 RPM NOTED

Performance shown does not include any interconnecting piping

NOTE: Series operation is limited by the operating pressure & NPSH requirement of a single pump. See single pump curve for NPSH, EFF., & HP.

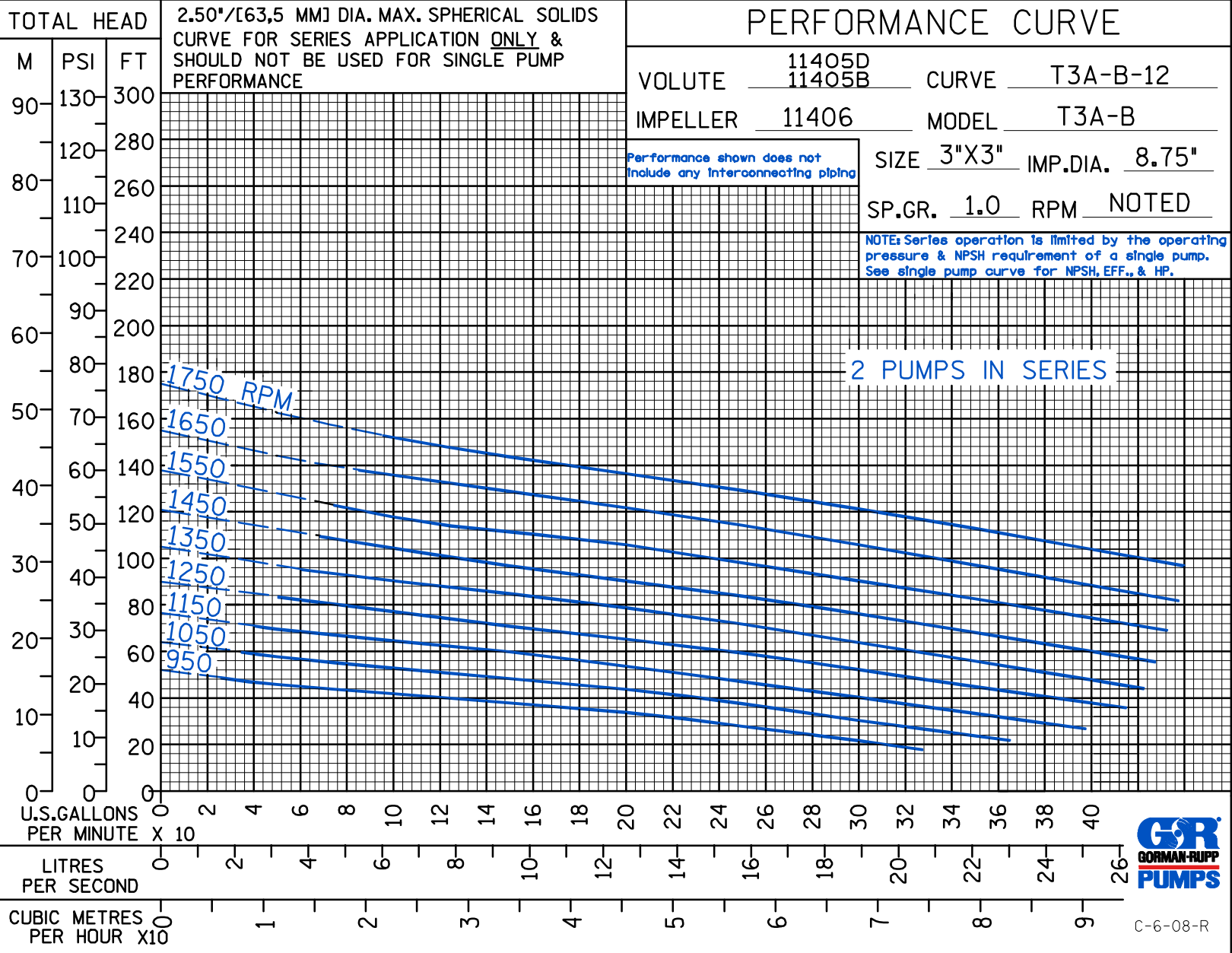

C-6-08-R



THE GORMAN-RUPP COMPANY • MANSFIELD, OHIO
 GORMAN-RUPP OF CANADA LIMITED • ST. THOMAS, ONTARIO, CANADA

www.grpumps.com
 Specifications Subject to Change Without Notice

Printed in U.S.A.