

c

# Self Priming Centrifugal Pump

**Super  
T SERIES**

VARIOUS PATENTS APPLY

## Model T4A60S-B

### Size 4" x 4"



#### PUMP SPECIFICATIONS

**Size:** 4" x 4" (101 mm x 101 mm) NPT - Female.

**Casing:** Gray Iron 30.

Maximum Operating Pressure 86 psi (593 kPa).\*

**Semi-Open Type, Two Vane Impeller:** Ductile Iron 65-45-12.

Handles 3" (76.2 mm) Diameter Spherical Solids.

**Impeller Shaft:** Alloy Steel 4150.

**Shaft Sleeve:** Alloy Steel 4130.

**Replaceable Wear Plate:** Carbon Steel 1015.

**Removable Adjustable Cover Plate:** Gray Iron 30; 41 lbs. (18 kg).

**Flap Valve:** Neoprene <sup>w</sup>/Nylon and Steel Reinforcing.

**Seal Plate:** Gray Iron 30.

**Bearing Housing:** Gray Iron 30.

**Radial Bearing:** Open Single Row Ball.

**Thrust Bearing:** Open Double Row Ball.

**Bearing and Seal Cavity Lubrication:** SAE 30 Non-Detergent Oil.

**Flanges:** 125# Gray Iron 30.

**Gaskets:** Buna-N, <sup>w</sup>/Compressed Synthetic Fibers, Vegetable Fiber, PTFE, Cork, and Rubber.

**O-Rings:** Buna-N.

**Hardware:** Standard Plated Steel.

**Brass Pressure Relief Valve.**

**Bearing and Seal Cavity Oil Level Sight Gauges.**

**Optional Equipment:** Metal Bellows Seal. Automatic Air Release Valve. G-R Hard Iron Impeller, Seal Plate, and Wear Plate. 120V/240V Casing Heater. High Pump Temperature Shutdown Kit. GR Hard Iron Casing. Self-Cleaning Wear Plate.

Gray Iron 30 Suction and Discharge Spool Flanges:

4" ASA (**Specify Model T4A60S-B /F**).

100 mm DIN 2527 (PN 16) (**Specify Model T4A60S-B /FM**).

*\*Consult Factory for Applications Exceeding Maximum Pressure and/or Temperature Indicated.*

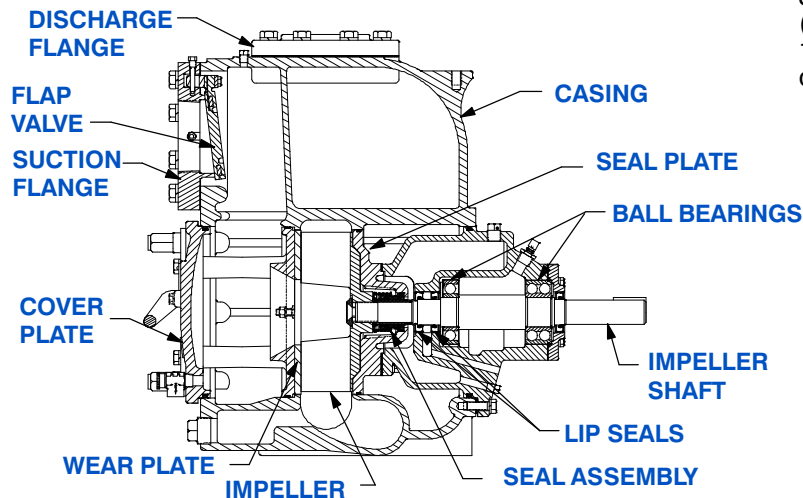

**Shown with Optional Suction & Discharge Spool Flanges (Available in ASA or DIN Standard Sizes).**

#### SEAL SPECIFICATIONS

Cartridge Type, Mechanical, Oil-Lubricated, Double Floating, Self-Aligning. Silicon Carbide Rotating and Stationary Faces. Stainless Steel 316 Stationary Seat. Fluorocarbon Elastomers (DuPont Viton<sup>®</sup> or Equivalent). Stainless Steel 18-8 Cage and Spring. Maximum Temperature of Liquid Pumped, 160°F (71°C).\*

#### SEAL DETAIL

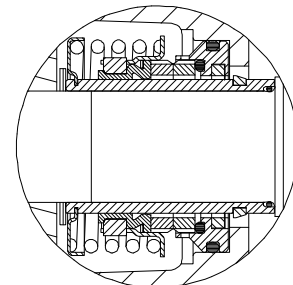

THE GORMAN-RUPP COMPANY • MANSFIELD, OHIO

GORMAN-RUPP OF CANADA LIMITED • ST. THOMAS, ONTARIO, CANADA

www.grpumps.com

Specifications Subject to Change Without Notice

Printed in U.S.A.

**Specification Data**

SECTION 55, PAGE 2110

**APPROXIMATE DIMENSIONS and WEIGHTS**

**NET WEIGHT: 575 LBS. (261 KG.)\***  
**SHIPPING WEIGHT: 614 LBS. (279 KG.)\***  
**EXPORT CRATE: 22.7 CU. FT. (0,64 CU. M.)**  
**\*ADD 15 LBS. (6,8 KG.) W/EACH SPOOL FLANGE**

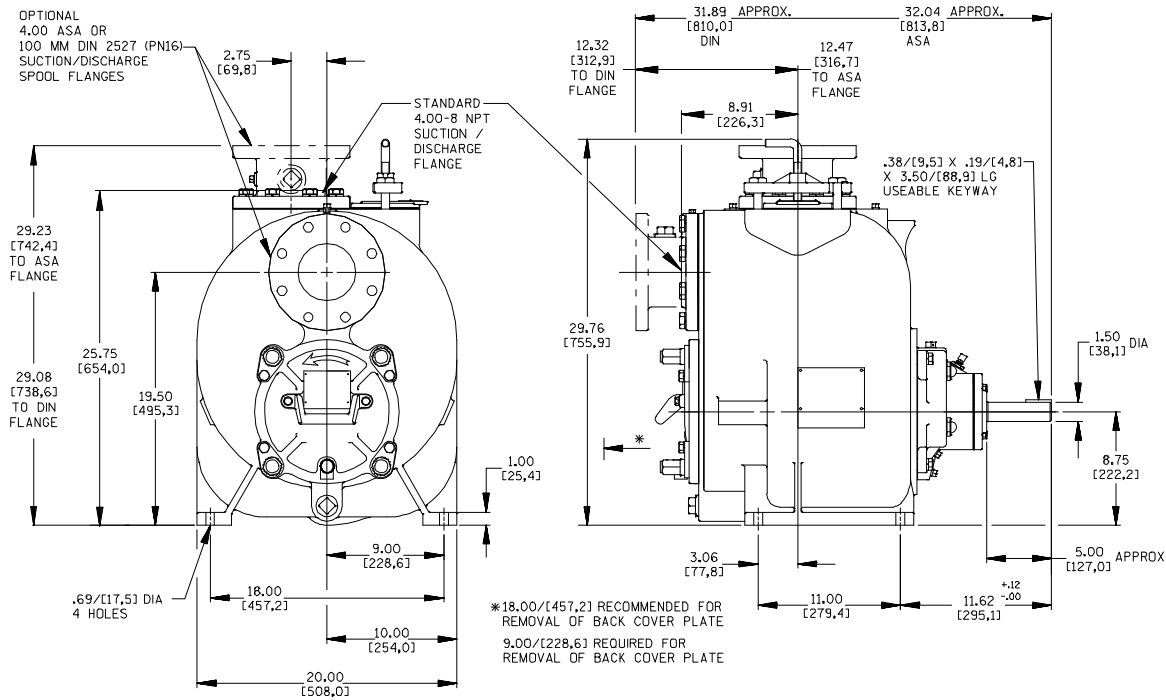

NOTE: OPTIONAL ASA OR DIN STANDARD SUCITON & DISCHARGE SPOOL FLANGES AVAILABLE.

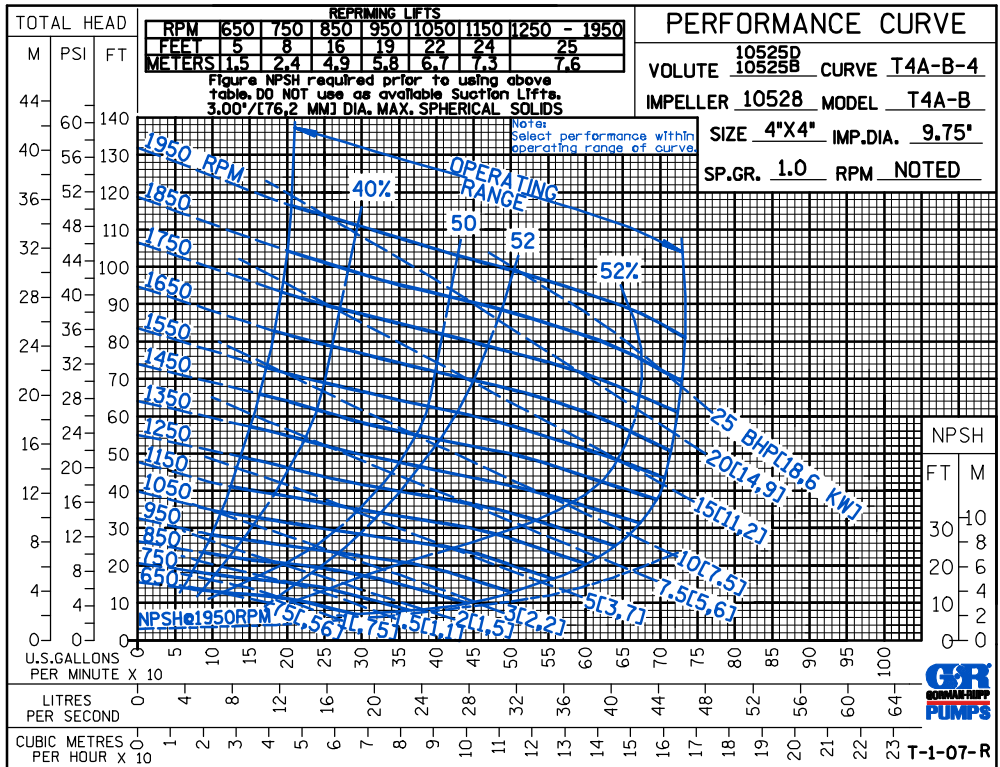

**THE GORMAN-RUPP COMPANY • MANSFIELD, OHIO**

GORMAN-RUPP OF CANADA LIMITED • ST. THOMAS, ONTARIO, CANADA

Specifications Subject to Change Without Notice

Printed in U.S.A.



THE GORMAN-RUPP COMPANY • MANSFIELD, OHIO

GORMAN-RUPP OF CANADA LIMITED • ST. THOMAS, ONTARIO, CANADA

www.grpumps.com

Specifications Subject to Change Without Notice

Printed in U.S.A.

© Copyright by the Gorman-Rupp Company 2008

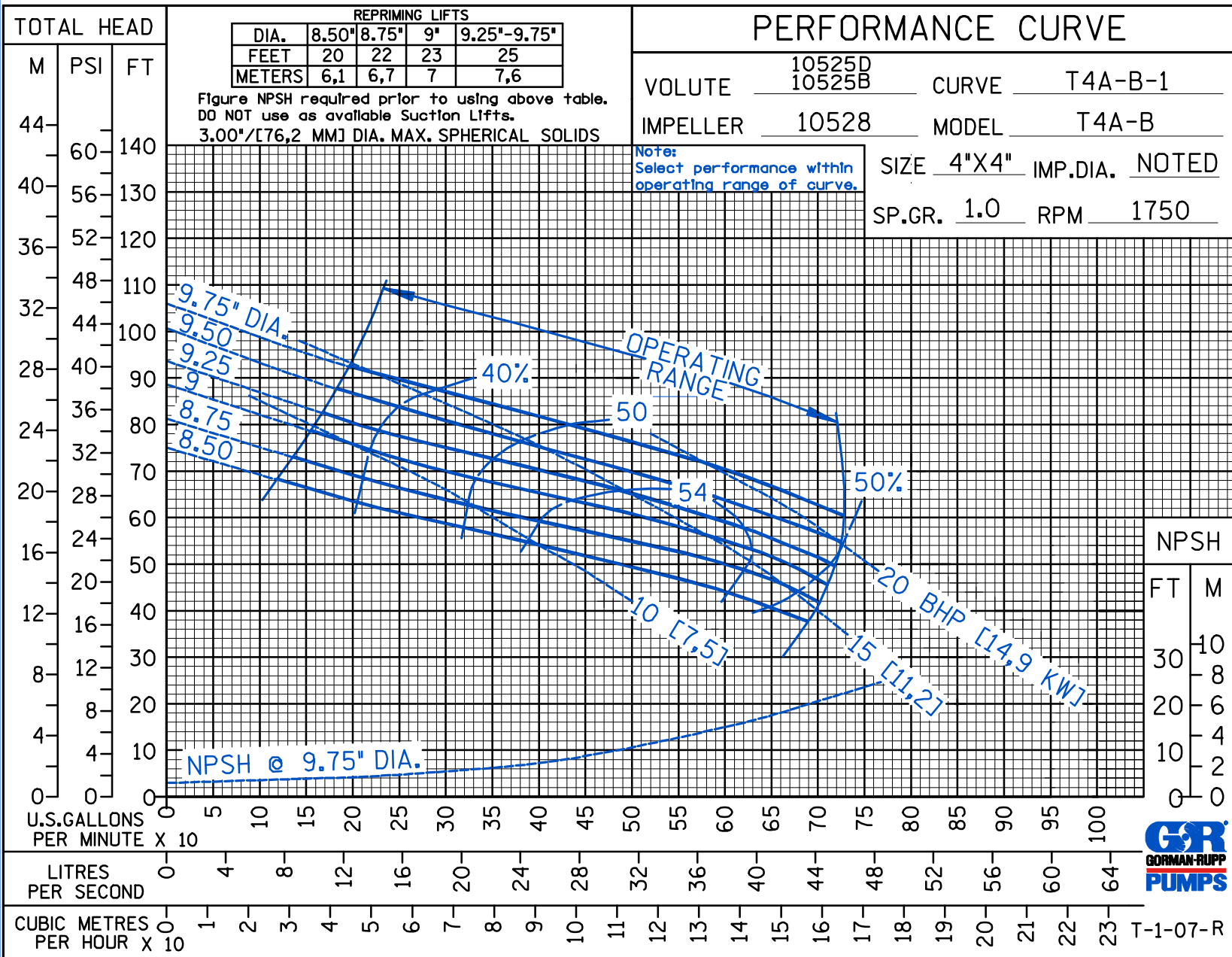

CDSW

Curve Data

Sec. 55

PAGE 2145.1  
JULY 2008



T-1-07-R

CDSW

# PERFORMANCE CURVE

VOLUTE 10525D  
10525B      CURVE T4A-B-2

IMPELLER 10528      MODEL T4A-B

SIZE 4"X4" IMP.DIA. NOTED

SP.GR. 1.0 RPM 1150

REPRIMING LIFTS						
DIA.	8.50"	8.75"	9"	9.25"	9.50"	9.75"
FEET	9	10	13	16	22	24
METERS	2,7	3,1	4	4,9	6,7	7,3

Figure NPSH required prior to using above table. DO NOT use as available Suction Lifts.

3.00"/[76,2 MM] DIA. MAX. SPHERICAL SOLIDS

Note:  
Select performance within operating range of curve.

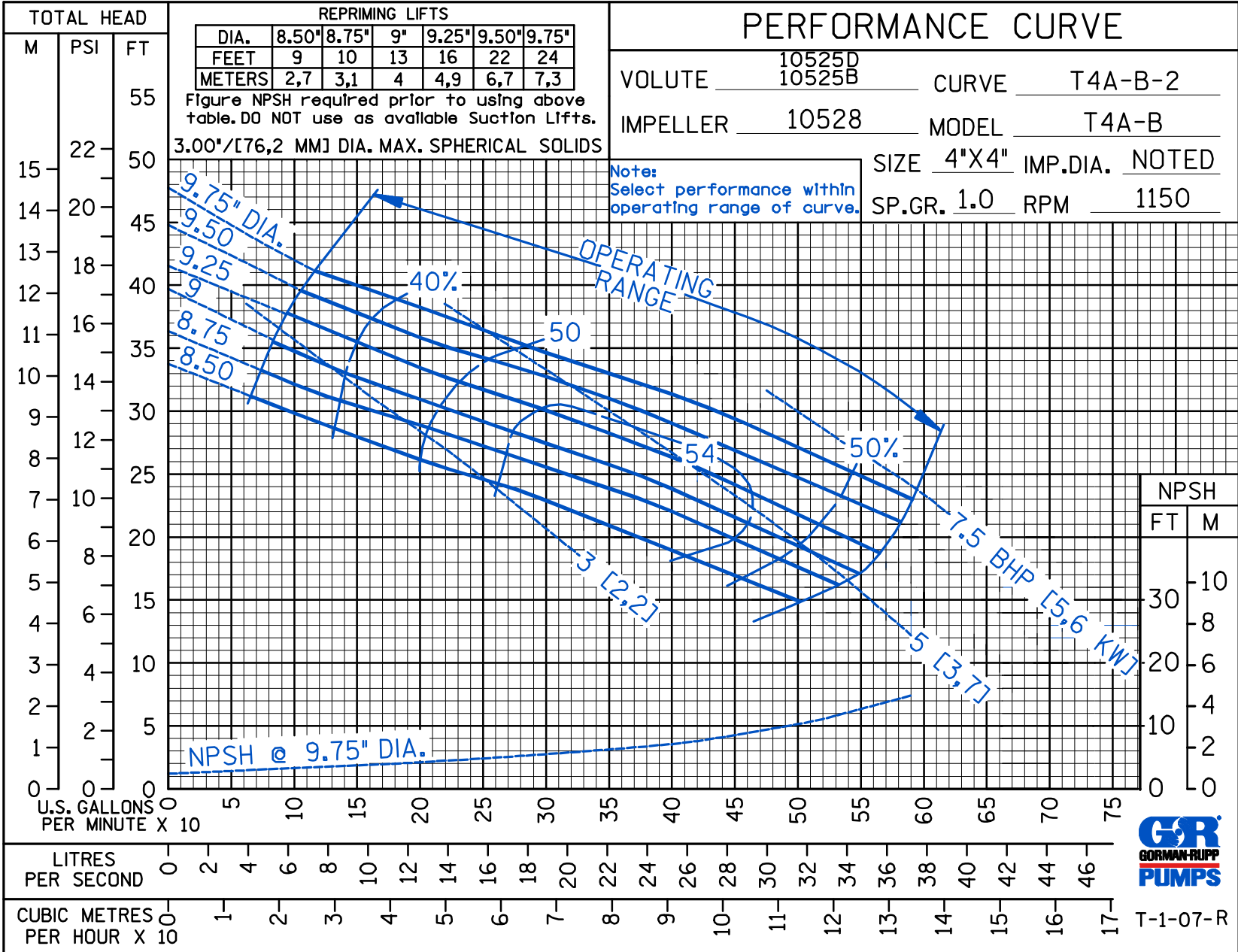

NPSH	
FT	M
30	10
20	6
10	3
0	0



T-1-07-R



THE GORMAN-RUPP COMPANY • MANSFIELD, OHIO  
GORMAN-RUPP OF CANADA LIMITED • ST. THOMAS, ONTARIO, CANADA

www.grpumps.com  
Specifications Subject to Change Without Notice

Printed in U.S.A.



THE GORMAN-RUPP COMPANY • MANSFIELD, OHIO

GORMAN-RUPP OF CANADA LIMITED • ST. THOMAS, ONTARIO, CANADA

www.grpmumps.com

Specifications Subject to Change Without Notice

Printed in U.S.A.

© Copyright by the Gorman-Rupp Company 2008

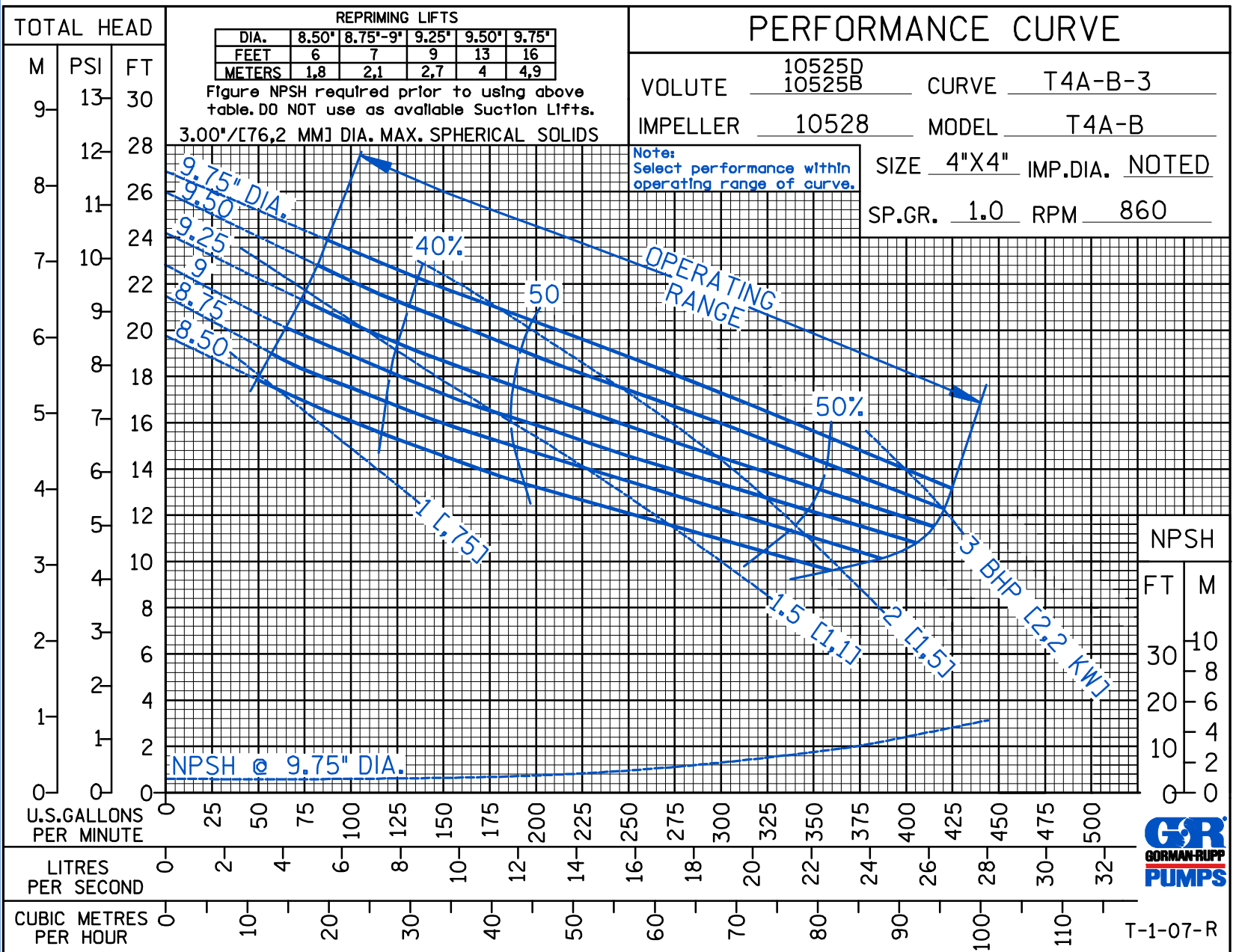

CDSW

Curve Data

Sec. 55

PAGE 2145.3  
JULY 2008



**THE GORMAN-RUPP COMPANY • MANSFIELD, OHIO**  
 GORMAN-RUPP OF CANADA LIMITED • ST. THOMAS, ONTARIO, CANADA  
 www.grpumps.com  
 Specifications Subject to Change Without Notice

© Copyright by the Gorman-Rupp Company 2008

Printed in U.S.A.

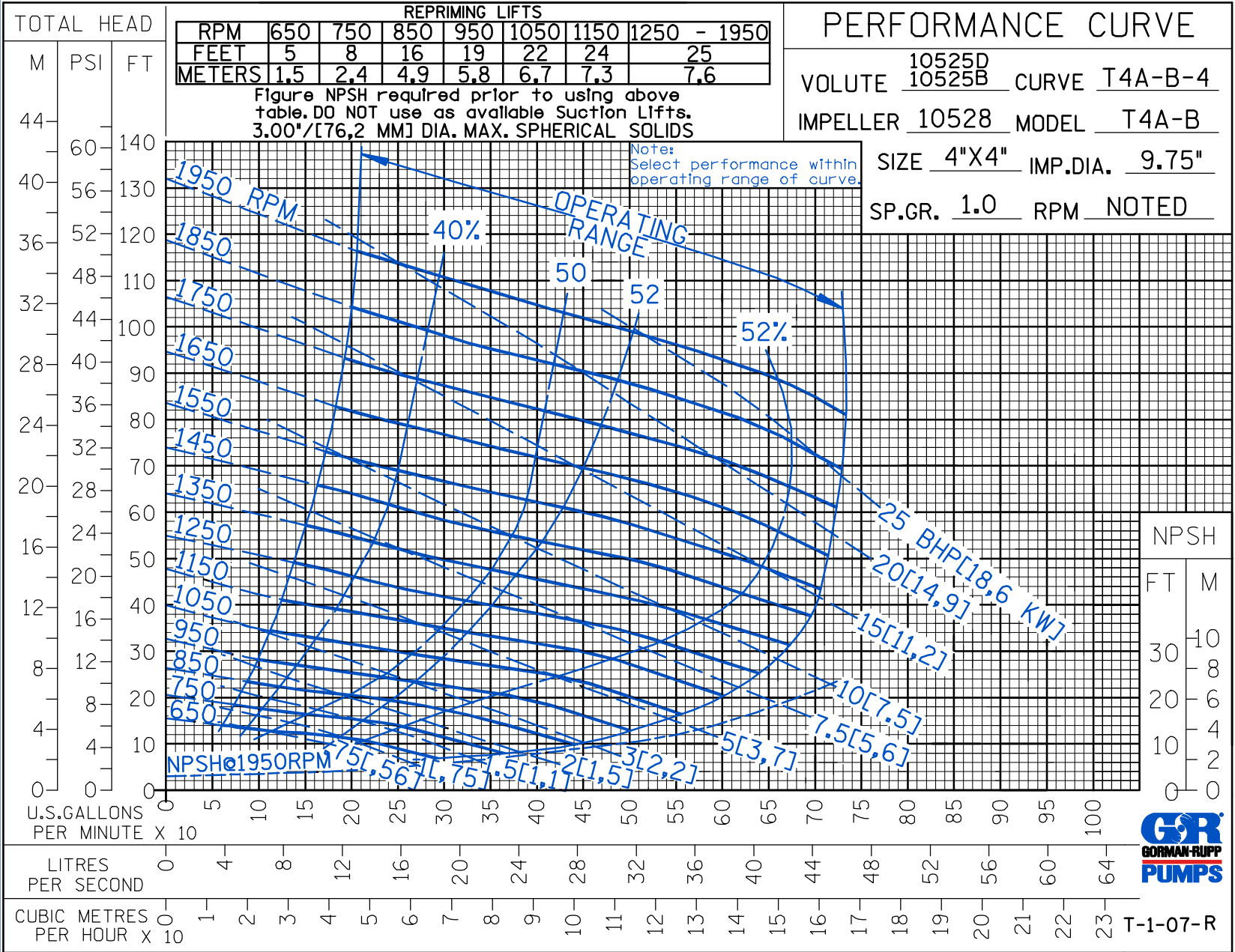

CDSW

Curve Data

Sec. 55

PAGE 2145.4  
 JULY 2008



THE GORMAN-RUPP COMPANY • MANSFIELD, OHIO

GORMAN-RUPP OF CANADA LIMITED • ST. THOMAS, ONTARIO, CANADA

www.grpumps.com

Specifications Subject to Change Without Notice

Printed in U.S.A.

© Copyright by the Gorman-Rupp Company 2008

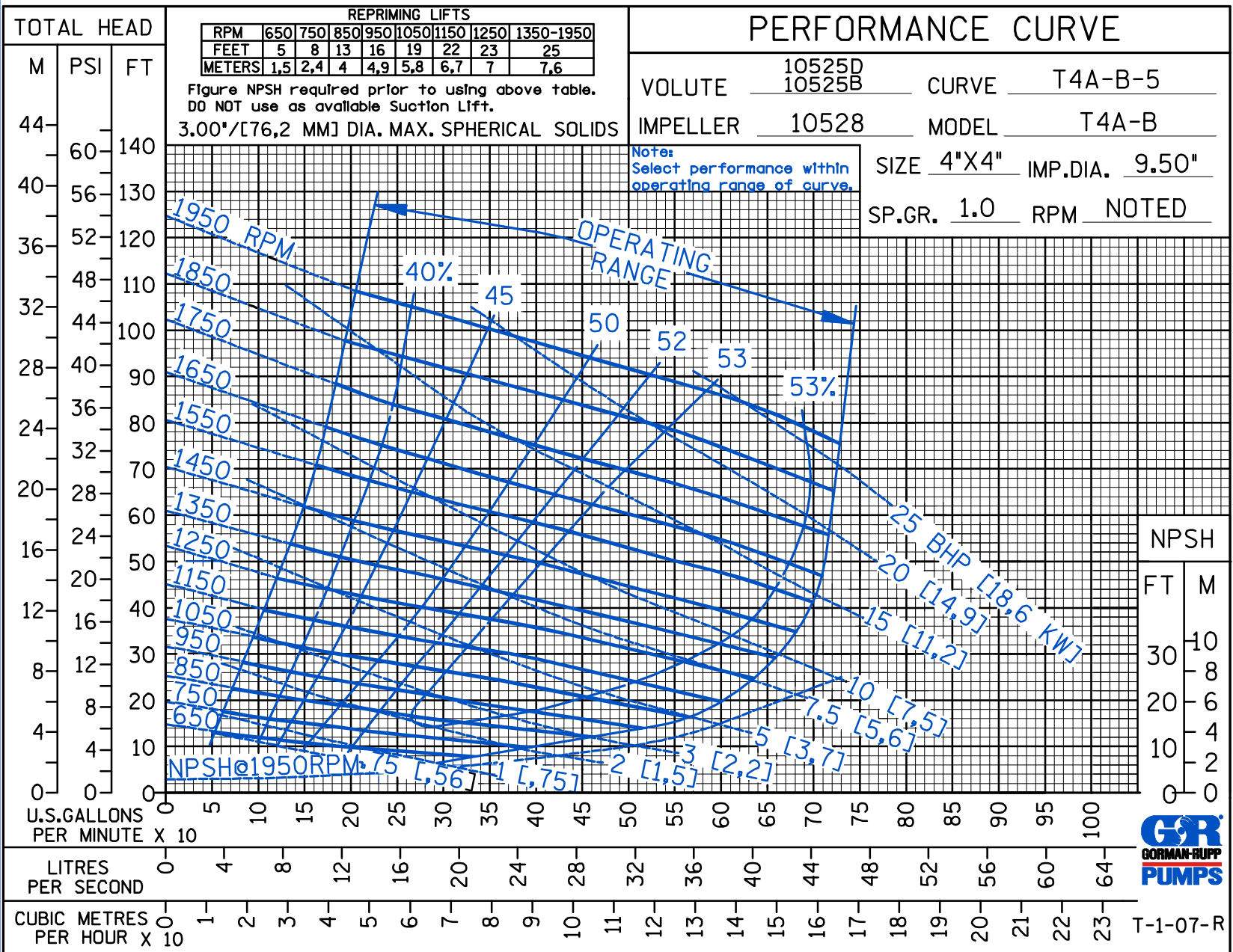

Curve Data

Sec. 55

PAGE 2145.5  
JULY 2008

CDSW



T-1-07-R



**THE GORMAN-RUPP COMPANY • MANSFIELD, OHIO**  
 GORMAN-RUPP OF CANADA LIMITED • ST. THOMAS, ONTARIO, CANADA  
 www.grpumps.com

© Copyright by the Gorman-Rupp Company 2008

Specifications Subject to Change Without Notice

Printed in U.S.A.

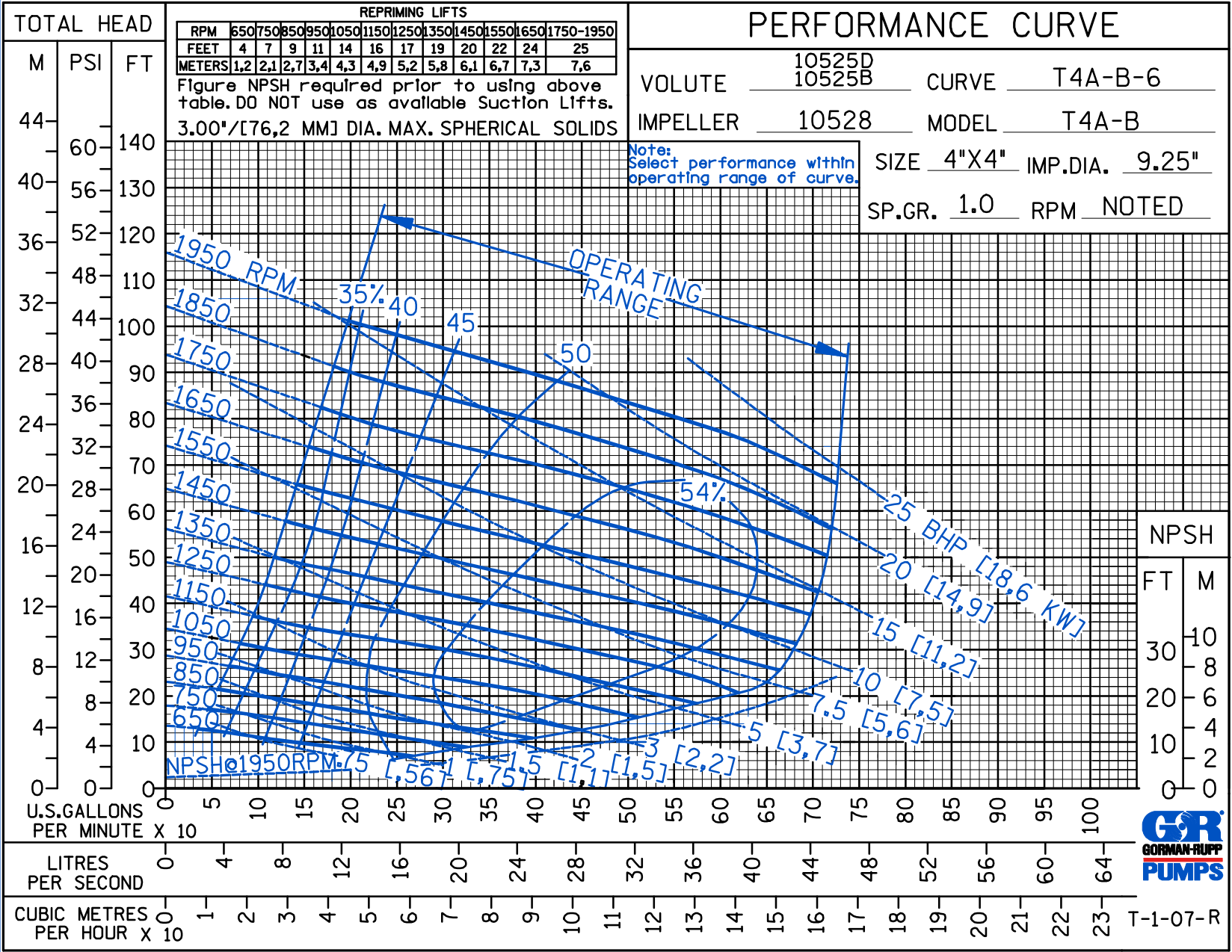

CDSW

Curve Data

Sec. 55

PAGE 2145.6  
 JULY 2008







THE GORMAN-RUPP COMPANY • MANSFIELD, OHIO

GORMAN-RUPP OF CANADA LIMITED • ST. THOMAS, ONTARIO, CANADA

www.grpumps.com

Specifications Subject to Change Without Notice

Printed in U.S.A.

© Copyright by the Gorman-Rupp Company 2008

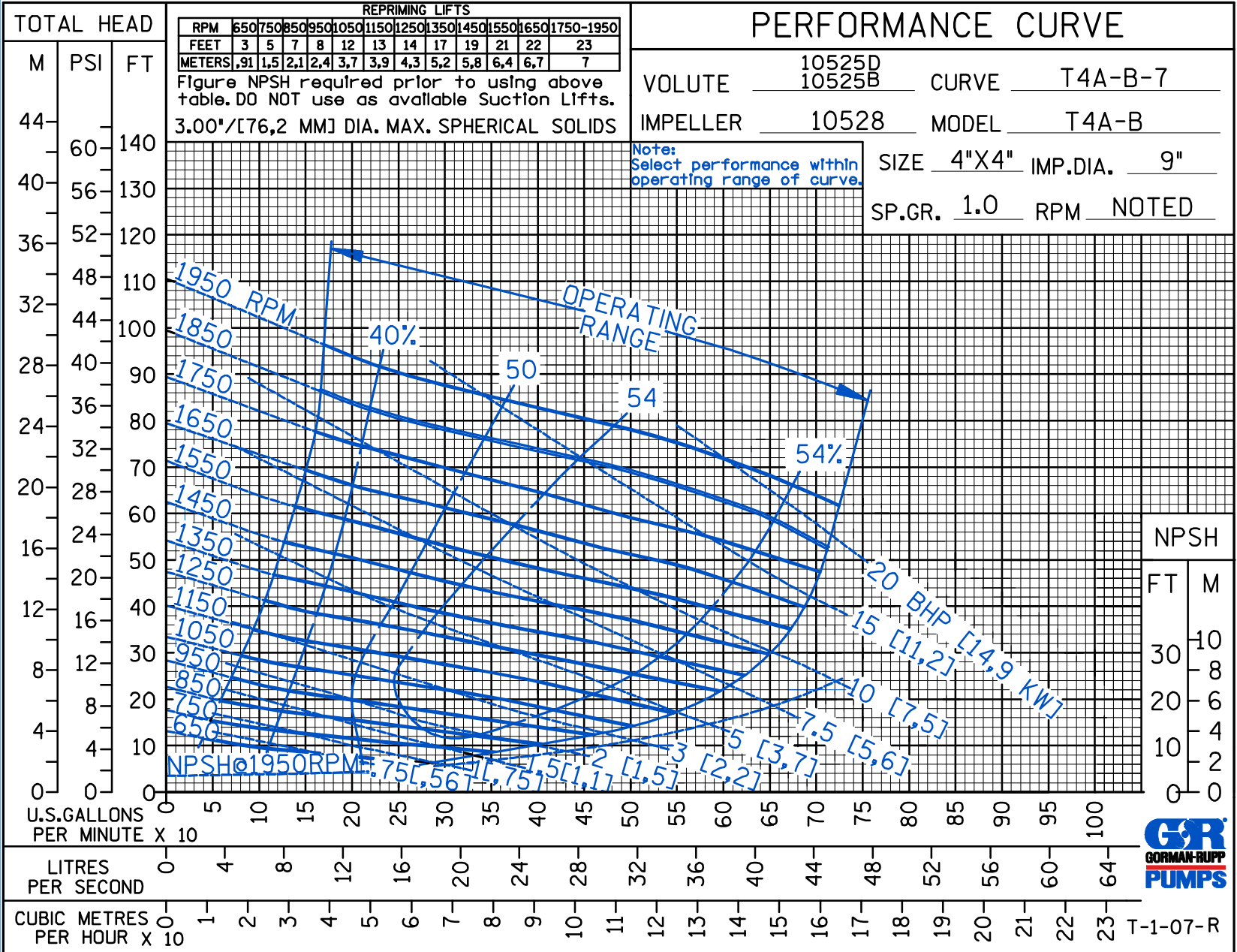

CDSW

Curve Data

Sec. 55

PAGE 2145.7  
JULY 2008



**THE GORMAN-RUPP COMPANY • MANSFIELD, OHIO**  
 GORMAN-RUPP OF CANADA LIMITED • ST. THOMAS, ONTARIO, CANADA  
 www.grpumps.com

© Copyright by the Gorman-Rupp Company 2008

Specifications Subject to Change Without Notice

Printed in U.S.A.

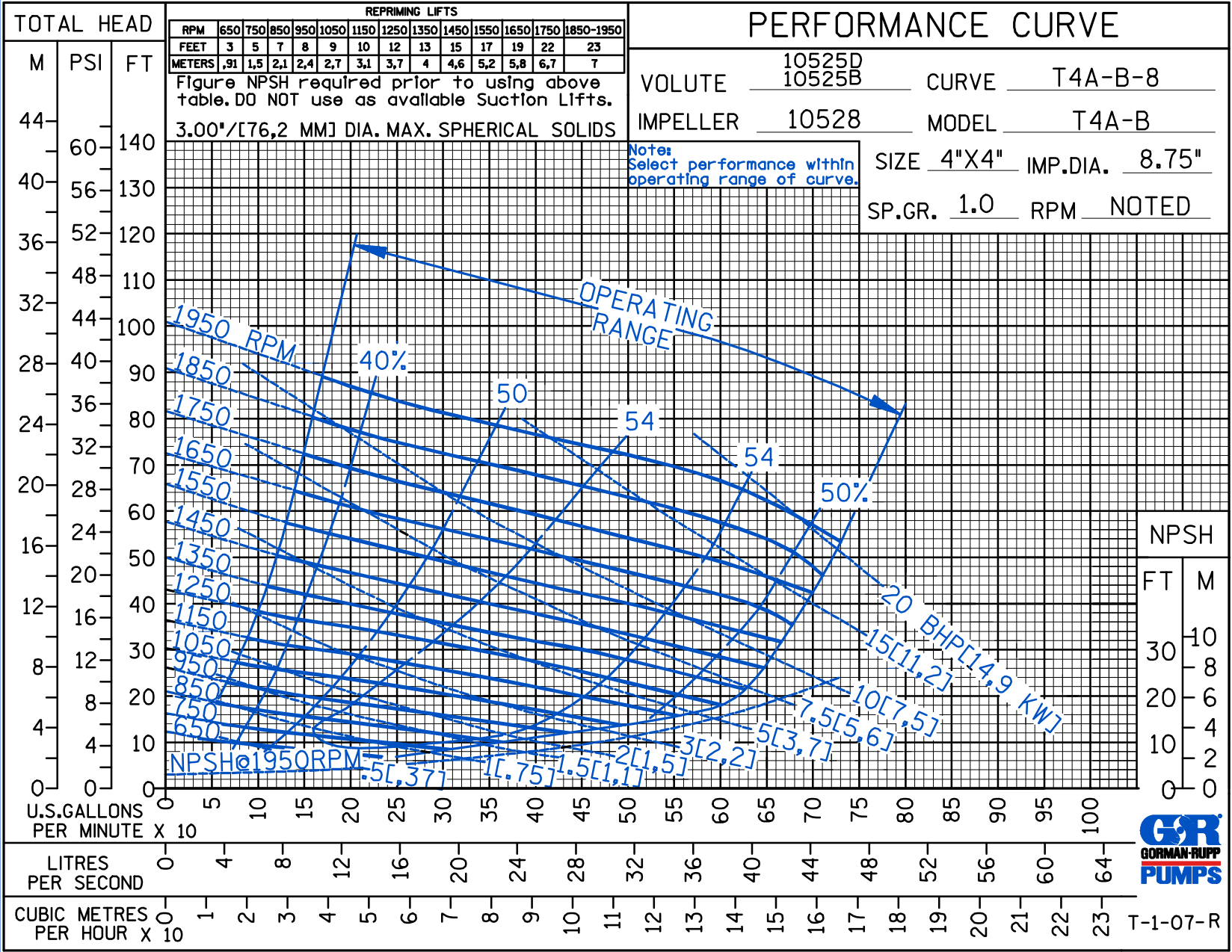

CDSW

Curve Data

Sec. 55

PAGE 2145.8  
 JULY 2008



THE GORMAN-RUPP COMPANY • MANSFIELD, OHIO

GORMAN-RUPP OF CANADA LIMITED • ST. THOMAS, ONTARIO, CANADA

www.grpumps.com

Specifications Subject to Change Without Notice

Printed in U.S.A.

© Copyright by the Gorman-Rupp Company 2008

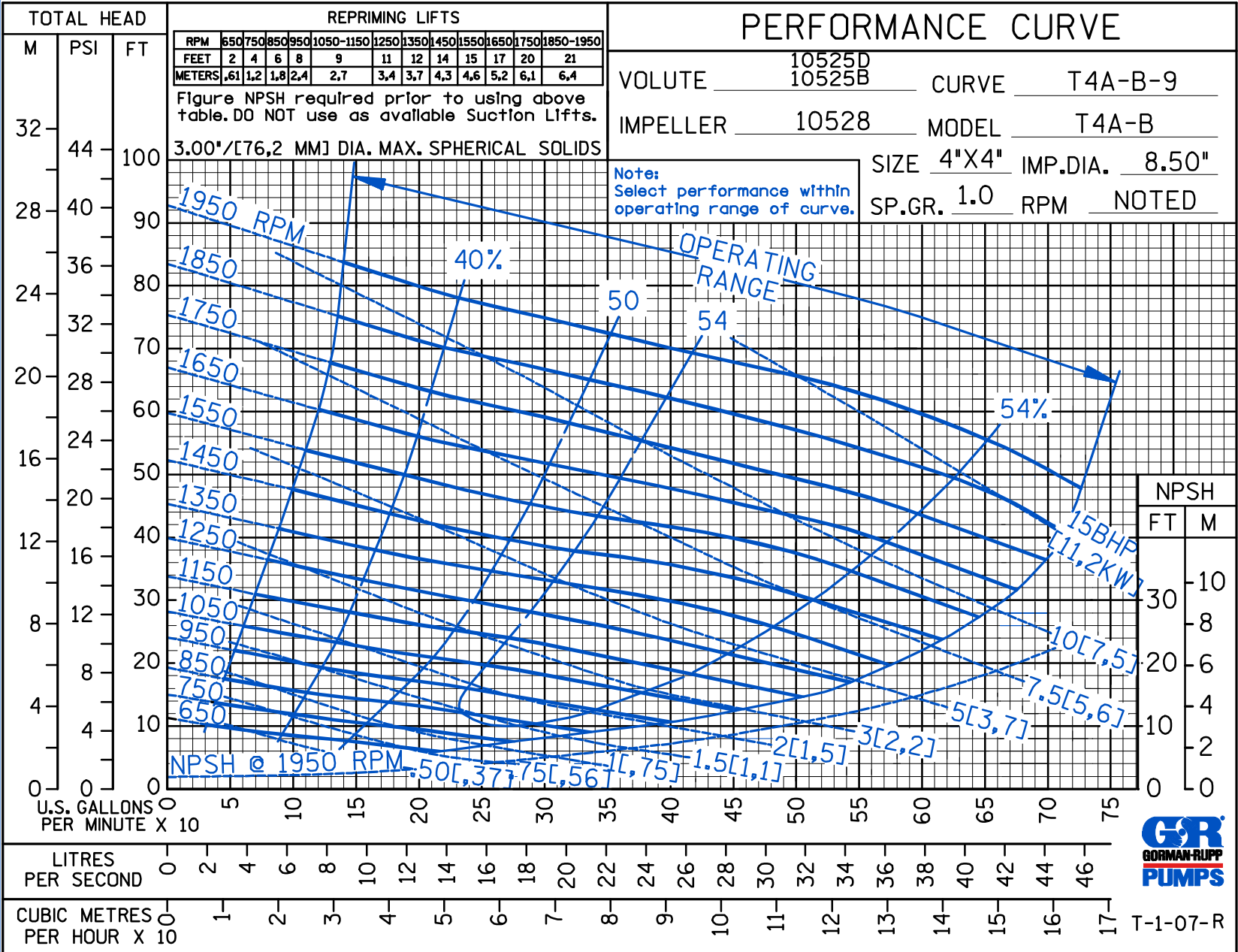

CDSW

Curve Data

Sec. 55

PAGE 2145.9  
JULY 2008



**THE GORMAN-RUPP COMPANY • MANSFIELD, OHIO**  
 GORMAN-RUPP OF CANADA LIMITED • ST. THOMAS, ONTARIO, CANADA  
 www.grpumps.com

© Copyright by the Gorman-Rupp Company 2008

Specifications Subject to Change Without Notice

Printed in U.S.A.

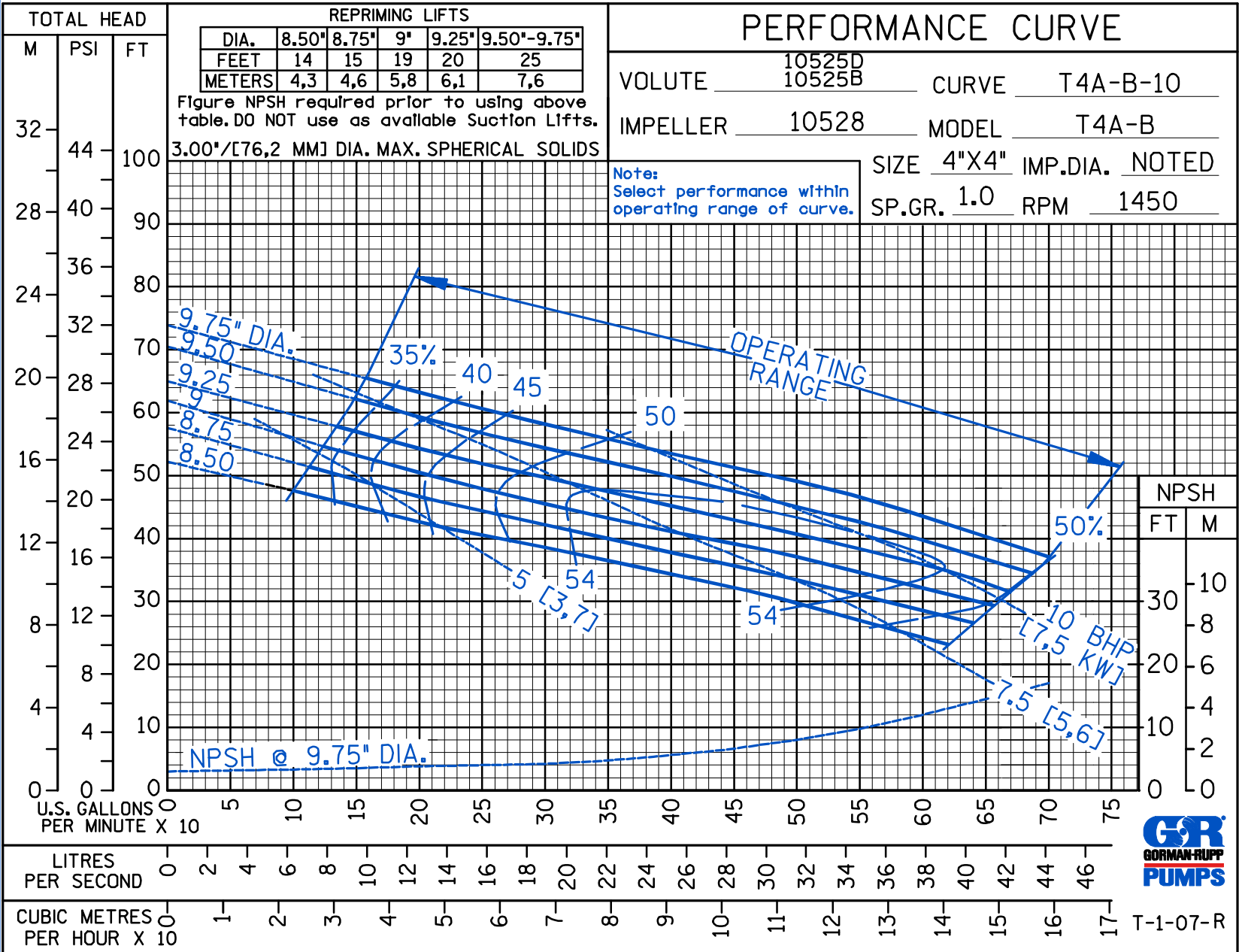

CDSW

Curve Data

Sec. 55

PAGE 2145.10  
JULY 2008



THE GORMAN-RUPP COMPANY • MANSFIELD, OHIO

GORMAN-RUPP OF CANADA LIMITED • ST. THOMAS, ONTARIO, CANADA

www.grpmumps.com

Specifications Subject to Change Without Notice

Printed in U.S.A.

© Copyright by the Gorman-Rupp Company 2008

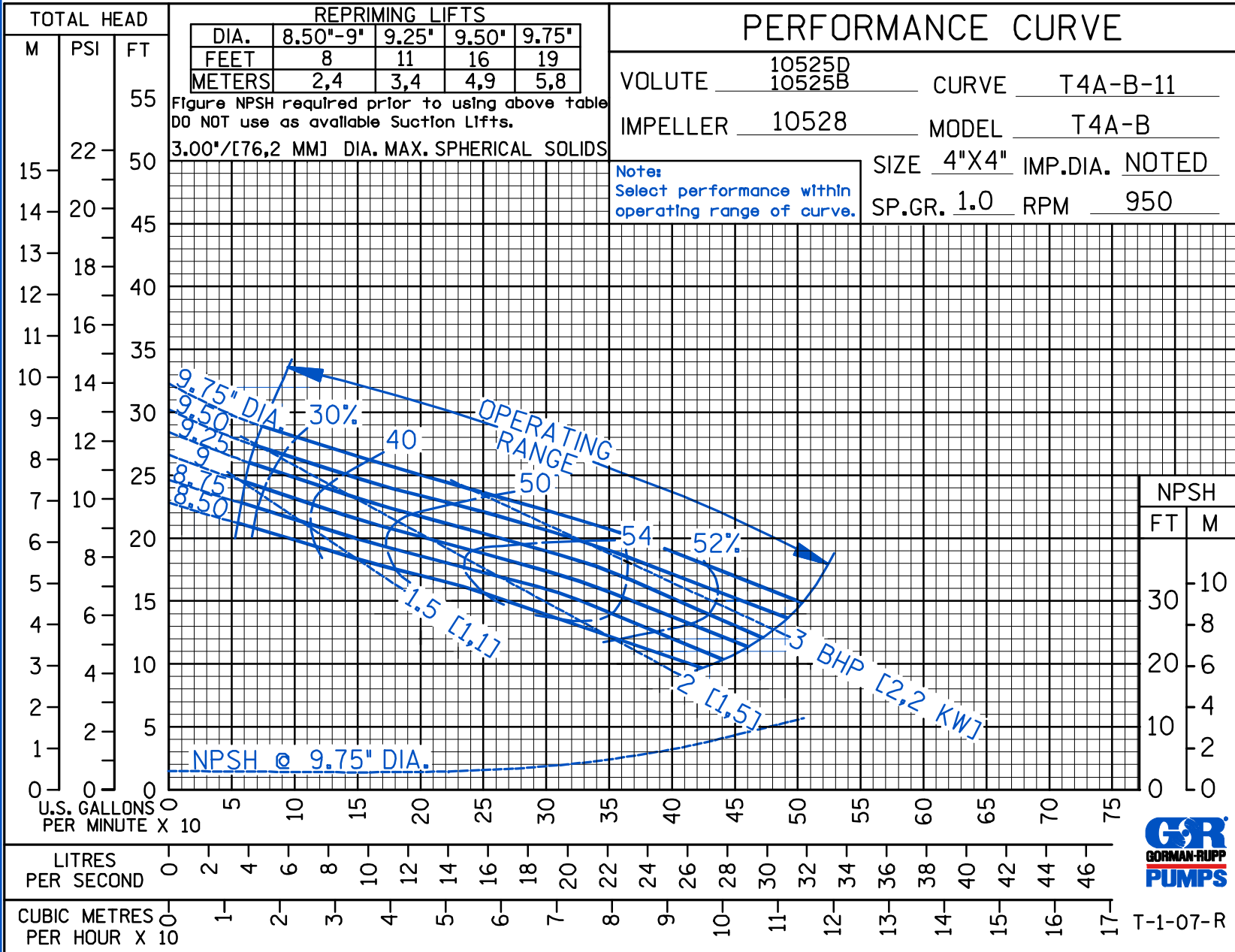

Curve Data

CDSW

Sec. 55

PAGE 2145.11  
JULY 2008

D S W

### PERFORMANCE CURVE

VOLUTE	10525D 10525B	CURVE	T4A-B-12
IMPELLER	10528	MODEL	T4A-B
		SIZE	4"X4" IMP.DIA. 9.75"
		SP.GR.	1.0 RPM NOTED

NOTE: See single pump curve for horsepower, efficiency, & NPSH

2 PUMPS IN PARALLEL

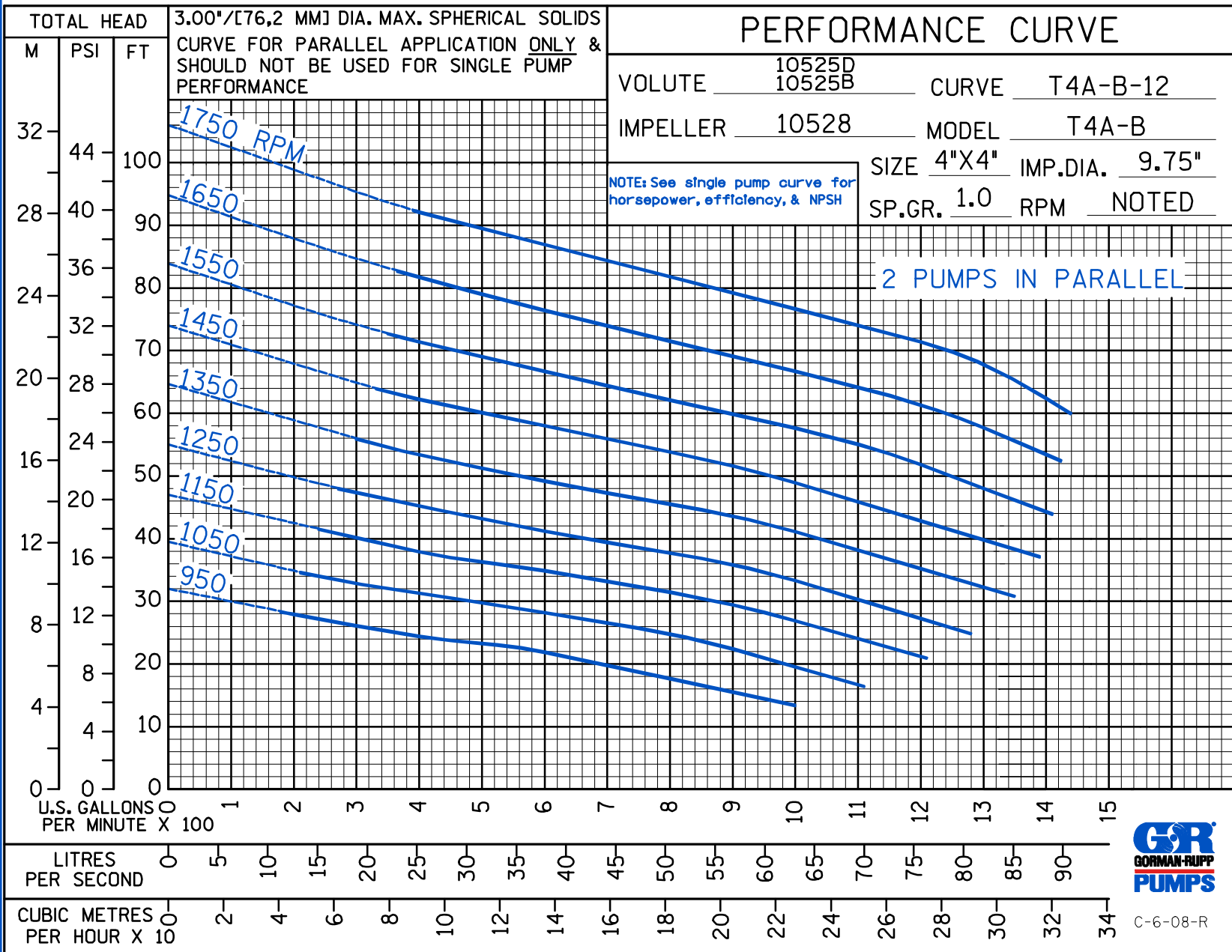

C-6-08-R



THE GORMAN-RUPP COMPANY • MANSFIELD, OHIO  
GORMAN-RUPP OF CANADA LIMITED • ST. THOMAS, ONTARIO, CANADA

www.grpumps.com  
Specifications Subject to Change Without Notice

Printed in U.S.A.



THE GORMAN-RUPP COMPANY • MANSFIELD, OHIO

GORMAN-RUPP OF CANADA LIMITED • ST. THOMAS, ONTARIO, CANADA

www.grpmumps.com

Specifications Subject to Change Without Notice

Printed in U.S.A.

© Copyright by the Gorman-Rupp Company 2008

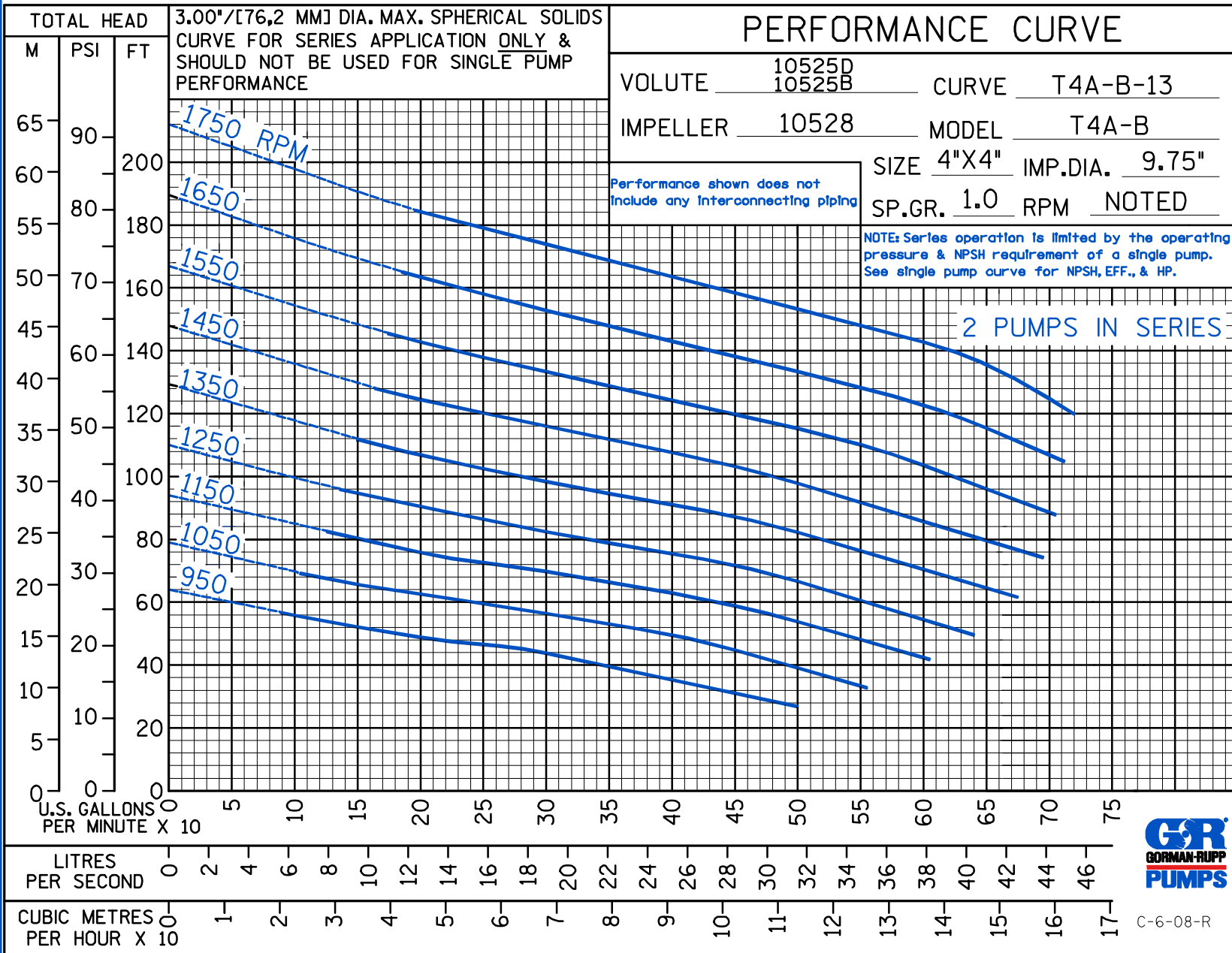

D S W

Curve Data

Sec. 55

PAGE 2145.13  
JULY 2008



C-6-08-R