

CM

Self-priming
50/60 Hz



1. Introduction	3
Product presentation	3
Applications	3
2. Features and benefits	4
3. Type key	5
4. Product range	6
5. Performance range	7
CM, 50 Hz	7
CM, 60 Hz	7
6. Operating conditions	8
Ambient temperature	8
Permissible liquid temperature and maximum operating pressure	8
Sound pressure	8
7. Installation of pump	9
8. Construction	11
Pump	11
9. Approvals and markings	12
Approvals	12
Markings	12
10. Selection and sizing	13
Selection of pumps	13
11. How to read the curve charts	15
Guidelines for performance curves	15
12. Performance curves, CM, 50 Hz	16
CM 1	16
CM 3	18
CM 5	20
13. Performance curves, CM, 60 Hz	24
CM 1	24
CM 3	26
CM 5	28
14. Dimensions	30
15. Weights and shipping volume	31
16. Motor data	32
Mains-operated motors, 50 Hz	32
Mains-operated motors, 60 Hz	32
17. Further product information	33
WebCAPS	33
WinCAPS	34
GO CAPS	35

1. Introduction

This data booklet is a supplement to the CM, CME data booklet. It describes all the features and characteristics specific to the CM self-priming model. For more detailed and further information about CM pumps, please follow the link below to open the relevant data booklet:



TM05 8814 2713

Product presentation



TM05 1127 2211

Fig. 1 Grundfos CM self-priming pump

The Grundfos CM self-priming pump is a horizontal, multistage, end-suction centrifugal pump.

CM self-priming pumps are fitted with mains-operated motors and have mechanical shaft seals.

As standard, the CM self-priming pump is available in stainless steel (EN 1.4301/AISI 304).

The CM self-priming pump is available in various sizes and numbers of stages to provide the flow and pressure required.

The pumps offer many advantages, some of which are listed below and described in detail in *Features and benefits* on page 4:

- compact design
- worldwide usage
- high reliability
- service-friendly
- wide performance range
- low noise
- customised solutions.

Applications



The CM self-priming pumps are designed for a wide variety of applications, ranging from small domestic installations to small industrial systems such as:

- water treatment
- domestic pressure boosting
- water supply for agriculture
- transfer and pressure boosting in rain water applications.

The CM self-priming pump can function as a main pump in a system or as a priming pump for other pumps that require a positive inlet pressure.

2. Features and benefits

CM self-priming pumps and CM pumps in general present the following features and benefits:

Compact design

Pump and motor are integrated in a compact and user-friendly design. The pump is fitted to a low-profile base plate, making it ideal for installation in systems where compactness is important.

Modular construction/customised solutions

The modular construction of the CM self-priming pumps makes it easy to create many different variants based on standard factory parts. This means that it is possible to create pump variants that are customised for the application in question.

Worldwide usage

With different voltage and frequency combinations, the CM self-priming product ranges cover markets worldwide.

High reliability

New state-of-the-art shaft seal design and materials offering these benefits:

- high wear resistance and long operating life
- improved sticking and dry-running capabilities.

The pumps are less sensitive to impurities in the pumped liquid than similar pumps of the canned-rotor type.

Easy installation and commissioning

A Quick Guide supplied with the CM pump enables easy installation and commissioning.

Detailed multilingual installation and operating instructions are supplied with each pump.

Service-friendly

- Service was in mind during the development.
- No special service tools are required.
- Spare parts are in stock for quick delivery.
- Service parts are available as kits, single parts or bulks.
- Service instructions and video make it simple to disassemble and assemble the pump.
- Service kit instructions are available where estimated necessary.

Self-priming

The CM self-priming pumps can create a suction lift of up to 8 metres in less than 5 minutes when the pump is installed and commissioned correctly.

Low sound pressure level

The CM self-priming pumps offer very silent operation.

High-performance hydraulics

Pump efficiency is maximised by the optimised hydraulics and carefully crafted production technology.

Electrocoated cast-iron parts

Electrocoated cast-iron parts optimise corrosion resistance.

Customised solutions

It is possible to create many different variants of the CM self-priming pumps:

- motor adaptation
- pump body modifications.

Grundfos motor

Grundfos motors are remarkably silent and highly efficient.

Grundfos motors are available with integrated frequency converter designed for speed-controlled operation.

Data and literature about the CM self-priming pumps

All literature and technical data related to CM self-priming pumps are available on line in Grundfos WebCAPS.

3. Type key

Example	CM	3	-6	O	-R	-I	-E	-A	V	B	E	C	-A	-A	-N	
Type range CM: Centrifugal Modular																Sensor N: No sensor
Rated flow rate Rated flow rate at 50 Hz [m ³ /h] Number of impellers																Mains plug A: Prepared for cable glands
Pump version O: Self-priming version (max. suction lift, 8 metres) S: Self-priming version (max. suction lift, 4 metres)																Motor information A: Standard motor (IP55)
Pipe connection R: Whitworth thread, Rp (ISO 7/1)																Supply voltage A: 1 x 220 V, 60 Hz C: 1 x 220-240 V, 50 Hz
Materials in contact with pump media I: Sleeve EN 1.4301/AISI 304 Pump shaft EN 1.4301/AISI 304 Impellers/chambers EN 1.4301/AISI 304																Material of secondary seal E: EPDM (ethylene propylene)
Rubber parts in pump (excluding neck ring and shaft) E: EPDM (ethylene propylene)																Material of stationary seal face B: Carbon, resin-impregnated Q: Silicon carbide (SiC)
																Material of rotating seal face Q: Silicon carbide (SiC) V: Aluminium oxide (Al ₂ O ₃)
																Shaft seal A: O-ring seal with fixed driver

Note: Other supply voltage, shaft seals combinations and pipe connections are available on request; Stainless steel EN 1.4401 / AISI 316 is also available on request.

5. Performance range

CM, 50 Hz

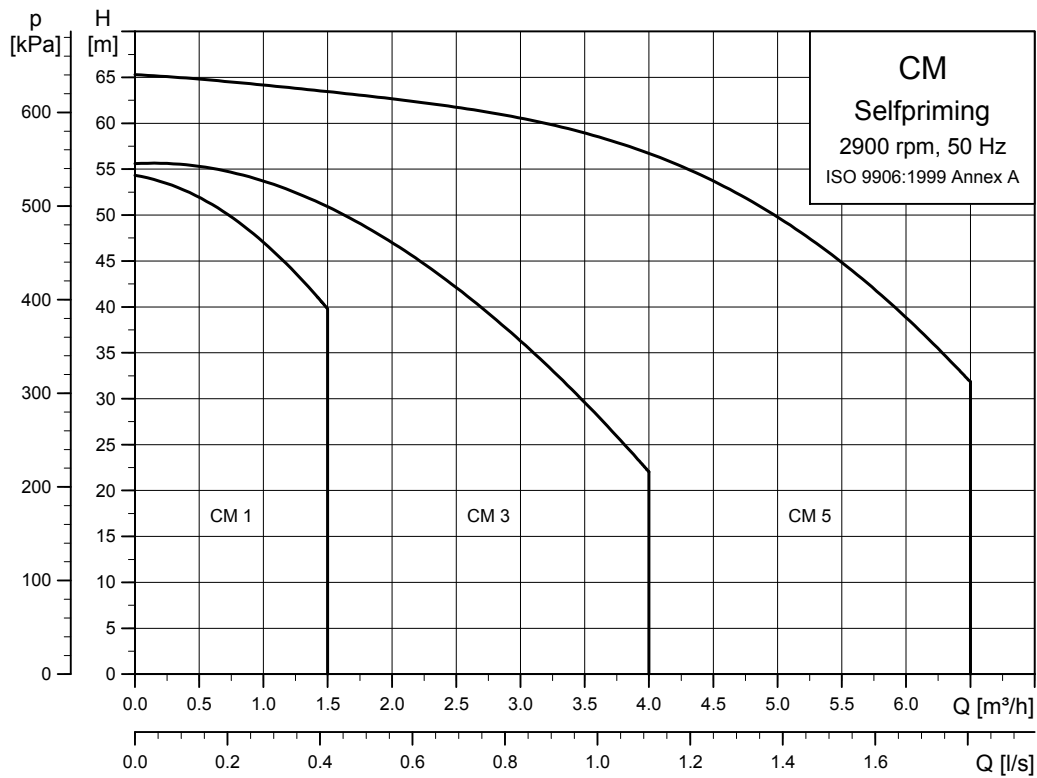

TM05 8834 2713

CM, 60 Hz

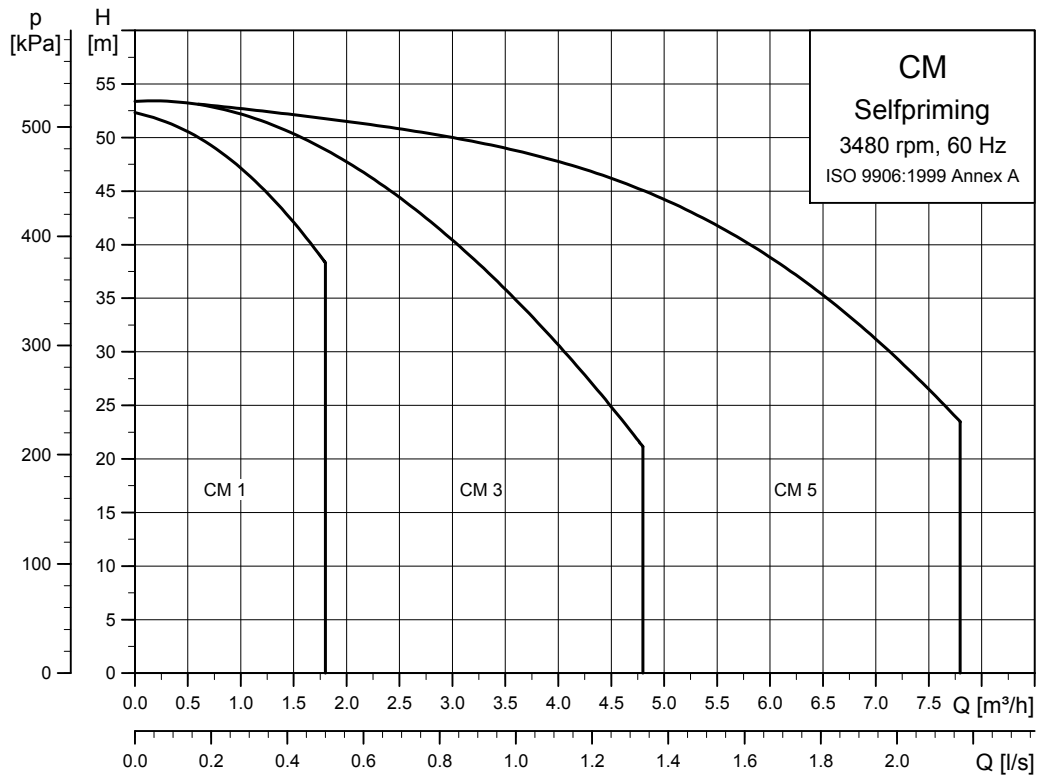

TM05 8835 2713

6. Operating conditions

Ambient temperature

Maximum ambient temperature	Liquid temperature
+55 °C	+60 °C

Note: The maximum ambient temperature for a CME self-priming model is 50 °C.

Permissible liquid temperature and maximum operating pressure

Material variant	Shaft seal	Permissible liquid temperature ¹⁾	Max. operating pressure
Stainless steel (EN 1.4301/AISI 304)	AVBx	0 to +40 °C +41 to +60 °C	10 bar 6 bar
	AQQx	0 to +60 °C	16 bar

¹⁾ At liquid temperatures below 0 °C (32 °F), higher motor outputs may be needed due to increased viscosity, for instance if glycol has been added to the water.

Note: Please contact Grundfos for further information.

Sound pressure

Model	Frequency	Sound pressure level
CM 1-3S, CM 1-4S, CM 1-5S, CM 1-6S	50 Hz	52 dB (A)
CM 3-3O/S, CM 3-4O/S, CM 3-5O/S CM 5-3O/S		
CM 3-6O/S		
CM 5-4O/S, CM 5-5O/S, CM 5-6O/S, CM 5-7O/S	60 Hz	54 dB (A)
CM 1-3S, CM 1-4S		
CM 3-3O/S, CM 3-4O/S		
CM 5-3O/S		
CM 5-4O/S		59 dB (A)

7. Installation of pump

The pump must be installed on a plane surface and fixed so that it cannot be displaced during startup and operation.

The pump must be installed so that the inlet is horizontal. Fig. 2 shows the permissible pump positions.

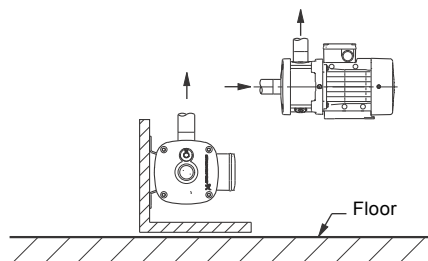

Fig. 2 Permissible pump positions

The pump should be installed with easy access for inspection, maintenance and service.

The pump should be installed in a well-ventilated location.

Pipe connection

The pump must be installed correctly to ensure that it can self-prime. See fig. 3.

- A minimum height must be observed from the centre of the suction port to the first tapping point (H1.a) or to the non-return valve (H1.b), if any installed in the discharge pipe. Minimum heights according to suction lifts are listed in the table below.
- The suction pipe must be at least 0.5 metres below the liquid level (H₃).

We recommend to install a filling plug (pos. A) in the discharge pipe. This facilitates liquid filling before startup.

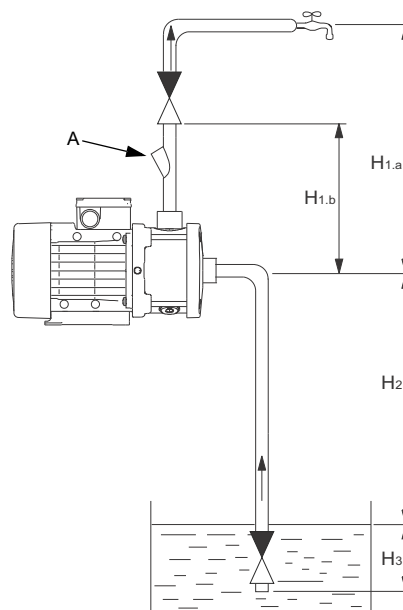

Fig. 3 Recommended piping for a self-priming pump

Suction lift (H ₂) [m]	Minimum height (H1.a or H1.b) [m]	
	Pump version O (max. suction lift, 8 metres)	Pump version S (max. suction lift, 4 metres)
≤ 3	0	0
≤ 4	≥ 0.20	0
> 4	≥ 0.20	0
5	≥ 0.35	0
6	≥ 0.5	0
7	≥ 0.6	0
8	≥ 0.7	0

Minimum inlet pressure, NPSH

Calculation of the inlet pressure "H" is recommended in these situations:

- The liquid temperature is high.
- The flow is significantly higher than the rated flow.
- Water is drawn from depths.
- Water is drawn through long pipes.
- Inlet conditions are poor.

To avoid cavitation, make sure that there is a minimum pressure on the suction side of the pump.

The maximum suction lift "H" in metres head can be calculated as follows:

$$H = p_b \times 10.2 - \text{NPSH} - H_f - H_v - H_s$$

p_b	= Barometric pressure in bar. (Barometric pressure can be set to 1 bar). In closed systems, p_b indicates the system pressure in bar.
NPSH	= Net Positive Suction Head in metres head. (To be read from the NPSH curve at the highest flow the pump will be delivering).
H_f	= Friction loss in suction pipe in metres head. (At the highest flow the pump will be delivering).
H_v	= Vapour pressure in metres head. (To be read from the vapour pressure scale, " H_v " depends on the liquid temperature " T_m ").
H_s	= Safety margin = minimum 0.5 metres head.

If the "H" calculated is positive, the pump can operate at a suction lift of maximum "H" metres head.

If the "H" calculated is negative, an inlet pressure of minimum "H" metres head is required.

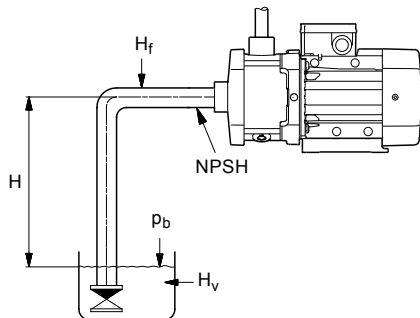

TM04 3487 4508

Fig. 4 Minimum inlet pressure (NPSH)

Note: To avoid cavitation, never select a pump with a duty point too far to the right on the NPSH curve.

Always check the NPSH value of the pump at the highest possible flow.

8. Construction

Pump

The CM self-priming pumps are horizontal, multistage centrifugal pumps. The pumps have an axial suction port and radial discharge port and are mounted on a base plate.

All movable parts are made of stainless steel, except for the syphon and the valve seat, which are made of a composite material.

The pumps are fitted with mains-operated motors.

All pumps incorporate a maintenance-free mechanical shaft seal.

Sectional drawing

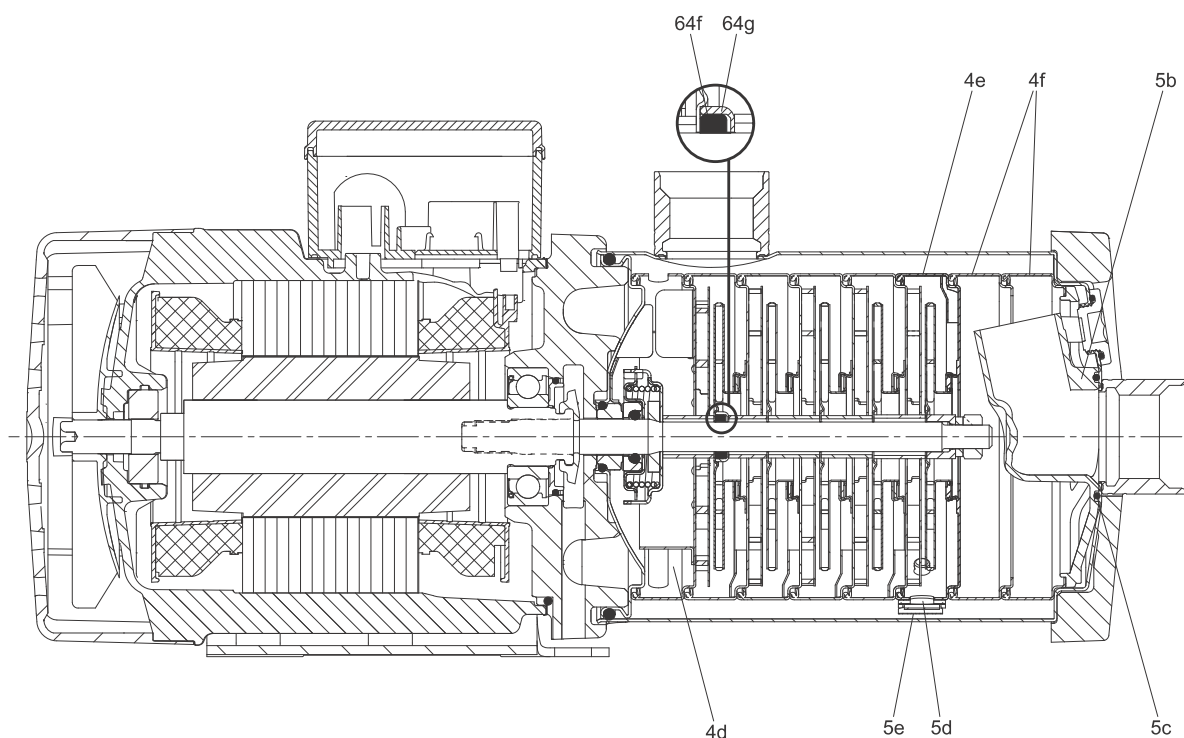

TM05 8874 2813

Fig. 5 CM 1-3 (self-priming version)

Components

Pos.	Description	Material
4d	Chamber complete with ribs and vanes	Stainless steel (EN 1.4301/AISI 304)
4e	Chamber with recirculation hole	Stainless steel (EN 1.4301/AISI 304)
4f	Empty chambers	Stainless steel (EN 1.4301/AISI 304)
5b	Syphon	Composite (Noryl 731s-701-1977)
5c	O-ring	EPDM
5d	Base for valve	Composite (Noryl 731s-701-1977)
5e	Spring plate	Stainless steel (EN 1.4310/AISI 301)
64f	Rubber seal	EPDM
64g	Container for rubber seal	Stainless steel (EN 1.4301/AISI 304)

9. Approvals and markings

The following approvals and markings are available as standard. Further approvals and markings are available on request. Contact Grundfos.

Approvals

- C-tick mark, New Zealand and Australian EMC
- TR certificate.

Other approvals and compliance with directives

- GOST (Russia)
- compliance with RoHS, directive 2002/96/EC.

Drinking water approvals

- WRAS
- ACS.

Markings



C-tick



CE



TR

10. Selection and sizing

Selection of pumps

Selection of pumps should be based on these elements:

- suction lift
- the duty point of the pump
- dimensional data such as pressure loss as a result of height differences, friction loss in the pipework, pump efficiency, etc.

Suction lift

The CM self-priming pumps come in two versions, each offering different suction lift capabilities:

- For a suction lift up to 4 metres, we recommend the S-type version.
- For a suction lift between 4 and 8 metres, the O-type version must be used.

See *Type key* on page 5.

Duty point

From a duty point, it is possible to select a pump on the basis of the curve charts starting on page 38.

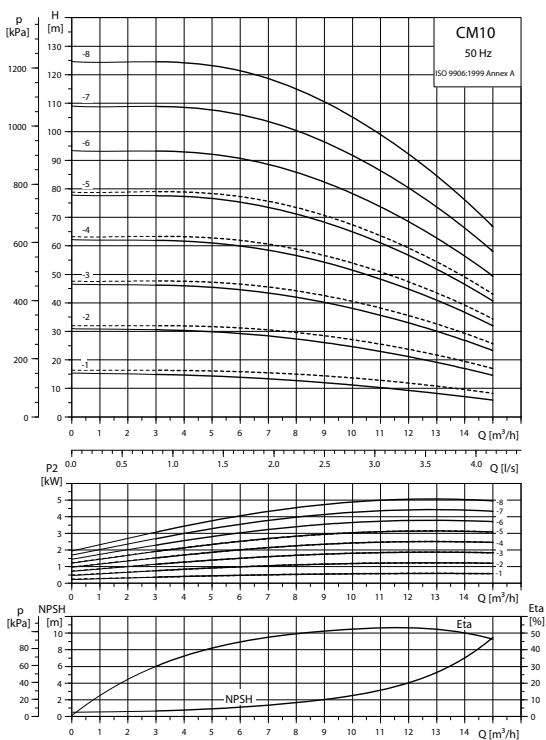

Fig. 6 Example of a curve chart

Dimensional data

When sizing a pump, take the following factors into account:

- Required flow and pressure at the draw-off point.
- Pressure loss as a result of height differences (H_{geo}).
- Friction loss in the pipework (H_f).
- Best efficiency at the estimated duty point.*
- NPSH value.

For calculation of the NPSH value, see *Minimum inlet pressure, NPSH* on page 10.

* See *How to read the curve charts* on page 15 for further information about sizing CM pumps.

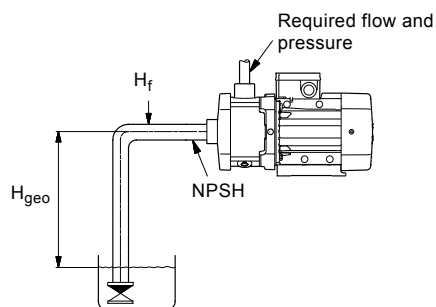

Fig. 7 Dimensional data

TM04 3486 4508

TM04 6404 5112

Pump efficiency

When sizing the pump, the efficiency (η) should be considered so that the pump will operate at or near its maximum efficiency, for instance on the right-hand side in the curve example in fig. 8.

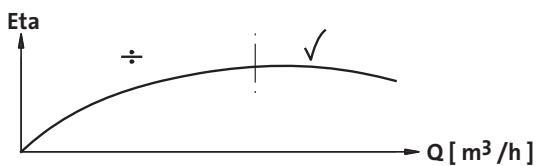

Fig. 8 Best efficiency

TM00 9190 1303

Before determining the best efficiency point, the operation pattern of the pump needs to be identified. If the pump is expected to operate at the same duty point, then select a CM pump which is operating at a duty point corresponding with the best efficiency of the pump. The example in fig. 9 shows how to check the pump efficiency when selecting a CM pump.

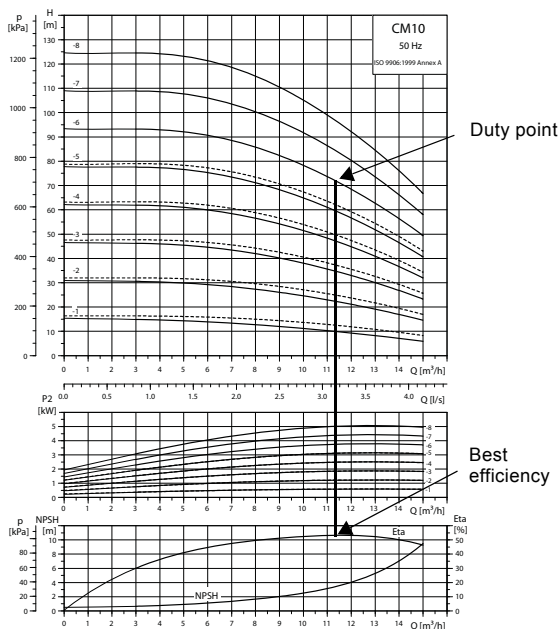

Fig. 9 Example of a CM pump's duty point

TM04 6404 5012

Pump connections



Fig. 10 Examples of pump connections

Selection of pump connection depends on the rated pressure and pipework. To meet any requirement, the CM self-priming pumps offer a wide range of flexible connections such as:

- Tri-Clamp®
- DIN flange
- ANSI flange
- JIS flange
- Victaulic® coupling
- Whitworth thread Rp
- internal NPT thread.

TM04 3937 0409

11. How to read the curve charts

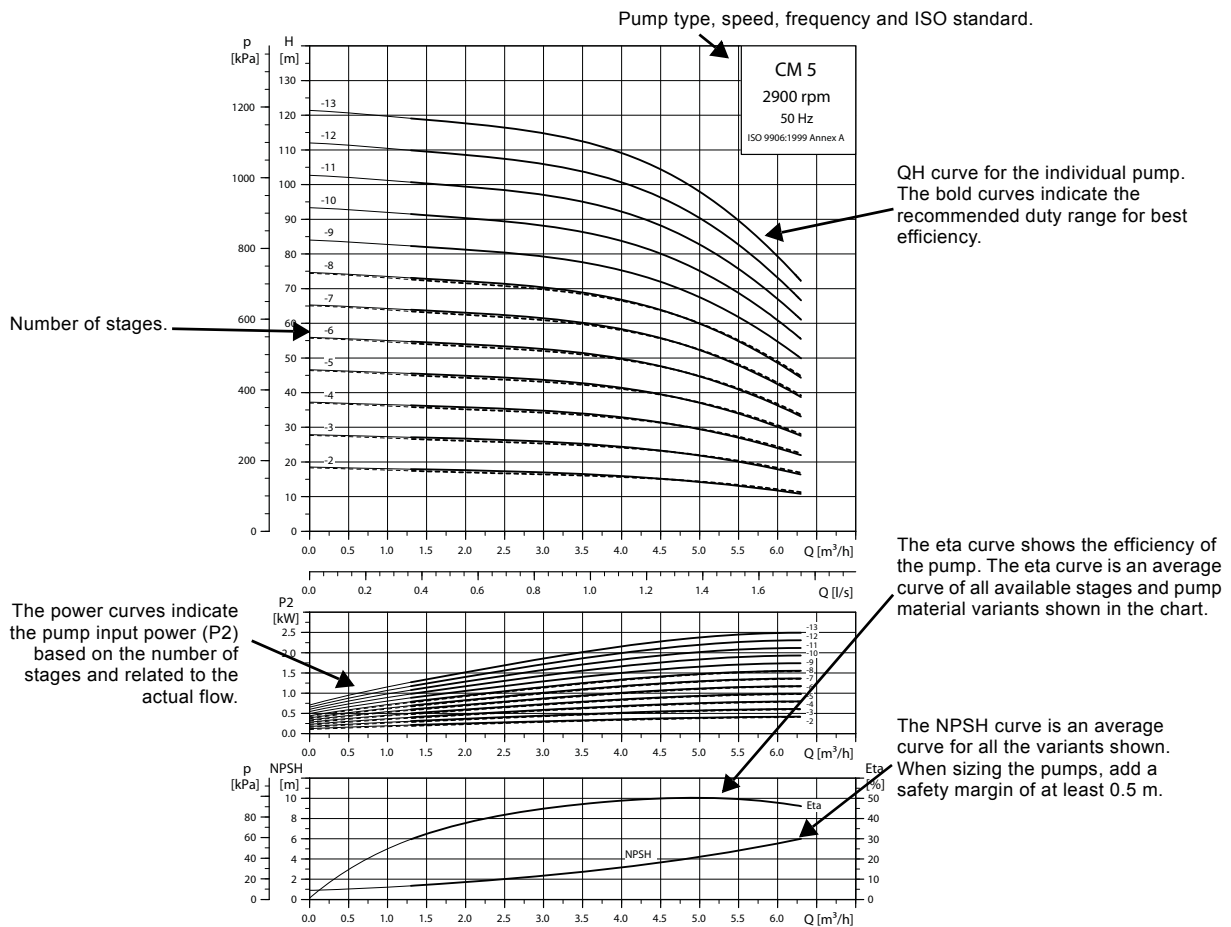

TM04 3336 5112

Fig. 11 Example of how to read the curve charts

Guidelines for performance curves

The guidelines below apply to the curves shown on the following pages:

- Tolerances to ISO 9906:1999, Annex A, if indicated.
- Measurements have been made with airless water at a temperature of +20 °C.
- The curves apply to the following kinematic viscosity: $\nu = 1 \text{ mm}^2/\text{s}$ (1 cSt).
- The QH curves apply to fixed speeds of 2900 min^{-1} (50 Hz) and 3480 min^{-1} (60 Hz).
Note: The actual speed will in most cases deviate from the above-mentioned speeds. So for realistic curves, please refer to WebCAPS where the pump curves include the characteristics of the selected motor and therefore show curves at actual speeds. In WebCAPS, it is also possible to adjust the curves depending on the density and viscosity.
- The conversion between head H (m) and pressure p (kPa) applies to a water density of $\rho = 1000 \text{ kg/m}^3$.

- Due to the risk of overheating, the pumps should not be used continuously at a flow below the minimum flow rate. The curve in fig. 12 shows the minimum flow rate as a percentage of the rated flow rate in relation to the liquid temperature.

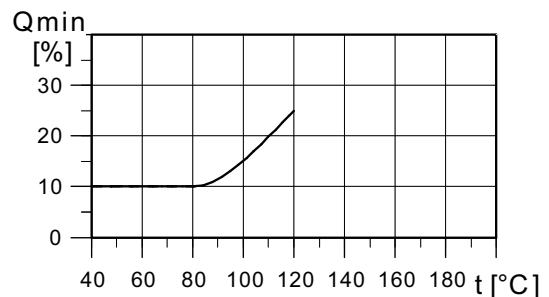
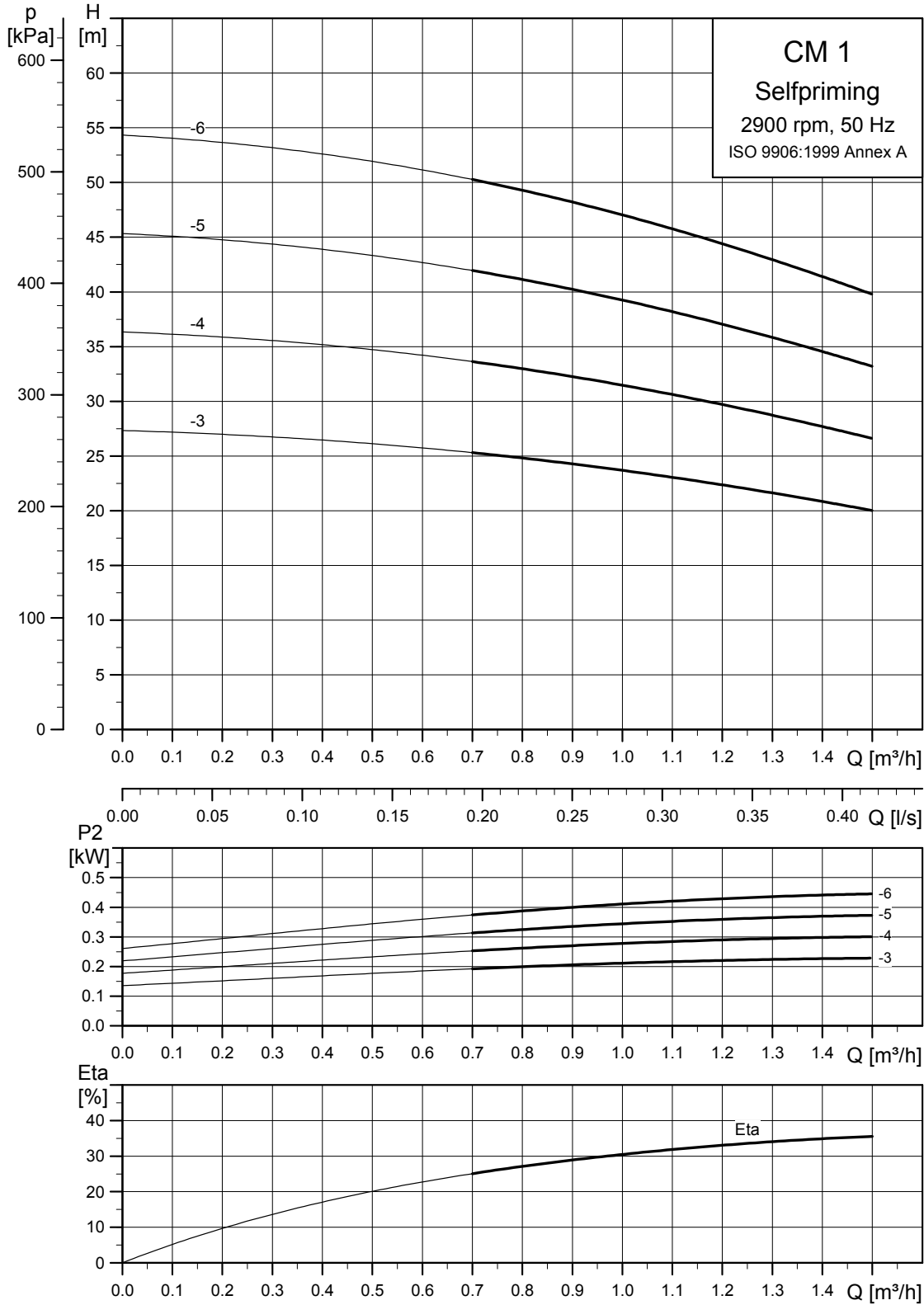

Fig. 12 Minimum flow rate

TM04 3791 5005

12. Performance curves, CM, 50 Hz

CM 1



Note: Pump performance is influenced by the suction lift. See page 17.

TM05 8756 2713

Pump performance in relation to suction lift

CM 1-3

Pump head [m]		Flow [m ³ /h]						
		0	0.25	0.5	0.75	1	1.25	1.5
Suction lift [m]	0	27.3	26.9	26.1	25.1	23.7	22.0	20.0
	1	26.3	25.9	25.1	24.1	22.7	21.0	19.0
	2	25.3	24.9	24.1	23.1	21.7	20.0	18.0
	3	24.3	23.9	23.1	22.1	20.7	19.0	17.0
	4	23.3	22.9	22.1	21.1	19.7	18.0	16.0

CM 1-4

Pump head [m]		Flow [m ³ /h]						
		0	0.25	0.5	0.75	1	1.25	1.5
Suction lift [m]	0	36.3	35.7	34.7	33.3	31.5	29.2	26.6
	1	35.3	34.7	33.7	32.3	30.5	28.2	25.6
	2	34.3	33.7	32.7	31.3	29.5	27.2	24.6
	3	33.3	32.7	31.7	30.3	28.5	26.2	23.6
	4	32.3	31.7	30.7	29.3	27.5	25.2	22.6

CM 1-5

Pump head [m]		Flow [m ³ /h]						
		0	0.25	0.5	0.75	1	1.25	1.5
Suction lift [m]	0	45.3	44.6	43.3	41.6	39.3	36.5	33.2
	1	44.3	43.6	42.3	40.6	38.3	35.5	32.2
	2	43.3	42.6	41.3	39.6	37.3	34.5	31.2
	3	42.3	41.6	40.3	38.6	36.3	33.5	30.2
	4	41.3	40.6	39.3	37.6	35.3	32.5	29.2

CM 1-6

Pump head [m]		Flow [m ³ /h]						
		0	0.25	0.5	0.75	1	1.25	1.5
Suction lift [m]	0	54.3	53.4	51.9	49.8	47.0	43.7	39.8
	1	53.3	52.4	50.9	48.8	46.0	42.7	38.8
	2	52.3	51.4	49.9	47.8	45.0	41.7	37.8
	3	51.3	50.4	48.9	46.8	44.0	40.7	36.8
	4	50.3	49.4	47.9	45.8	43.0	39.7	35.8

CM 3

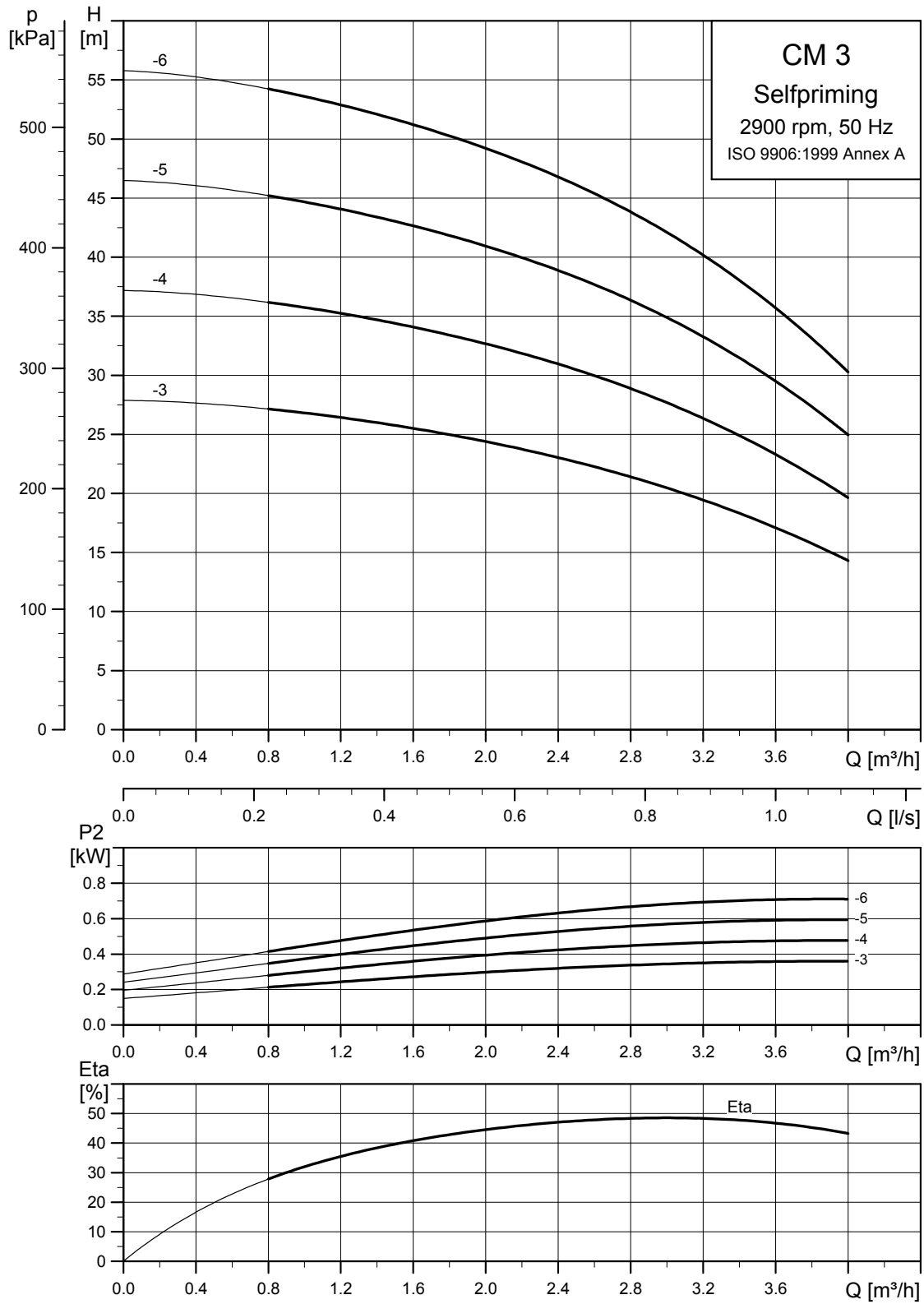

Note: Pump performance is influenced by the suction lift. See page 19.

TM05 8757 2713

Pump performance in relation to suction lift

CM 3-3

Pump head [m]		Flow [m ³ /h]								
		0	0.5	1	1.5	2	2.5	3	3.5**	4**
Suction lift [m]	0	27.9	27.5	26.8	25.8	24.4	22.7	20.5	17.7	14.3
	1	26.9	26.5	25.8	24.8	23.4	21.7	19.5	16.7	13.3
	2	25.9	25.5	24.8	23.8	22.4	20.7	18.5	15.7	12.3
	3	24.9	24.5	23.8	22.8	21.4	19.7	17.5	14.7	11.3
	4	23.9	23.5	22.8	21.8	20.4	18.7	16.5	13.7	10.3
	5*	22.9	22.5	21.8	20.8	19.4	17.7	15.5	-	-
	6*	21.9	21.5	20.8	19.8	18.4	16.7	14.5	-	-
	7*	20.9	20.5	19.8	18.8	17.4	15.7	-	-	-
	8*	19.9	19.5	18.8	17.8	-	-	-	-	-

CM 3-4

Pump head [m]		Flow [m ³ /h]								
		0	0.5	1	1.5	2	2.5	3	3.5**	4**
Suction lift [m]	0	37.2	36.7	35.7	34.4	32.7	30.5	27.7	24.1	19.6
	1	36.2	35.7	34.7	33.4	31.7	29.5	26.7	23.1	18.6
	2	35.2	34.7	33.7	32.4	30.7	28.5	25.7	22.1	17.6
	3	34.2	33.7	32.7	31.4	29.7	27.5	24.7	21.1	16.6
	4	33.2	32.7	31.7	30.4	28.7	26.5	23.7	20.1	15.6
	5*	32.2	31.7	30.7	29.4	27.7	25.5	22.7	-	-
	6*	31.2	30.7	29.7	28.4	26.7	24.5	21.7	-	-
	7*	30.2	29.7	28.7	27.4	25.7	23.5	-	-	-
	8*	29.2	28.7	27.7	26.4	-	-	-	-	-

CM 3-5

Pump head [m]		Flow [m ³ /h]								
		0	0.5	1	1.5	2	2.5	3	3.5**	4**
Suction lift [m]	0	46.5	45.9	44.7	43.0	40.9	38.3	34.9	30.5	25.0
	1	45.5	44.9	43.7	42.0	39.9	37.3	33.9	29.5	24.0
	2	44.5	43.9	42.7	41.0	38.9	36.3	32.9	28.5	23.0
	3	43.5	42.9	41.7	40.0	37.9	35.3	31.9	27.5	22.0
	4	42.5	41.9	40.7	39.0	36.9	34.3	30.9	26.5	21.0
	5*	41.5	40.9	39.7	38.0	35.9	33.3	29.9	-	-
	6*	40.5	39.9	38.7	37.0	34.9	32.3	28.9	-	-
	7*	39.5	38.9	37.7	36.0	33.9	31.3	-	-	-
	8*	38.5	37.9	36.7	35.0	-	-	-	-	-

CM 3-6

Pump head [m]		Flow [m ³ /h]								
		0	0.5	1	1.5	2	2.5	3	3.5**	4**
Suction lift [m]	0	55.8	55.0	53.6	51.7	49.2	46.1	42.1	36.9	30.3
	1	54.8	54.0	52.6	50.7	48.2	45.1	41.1	35.9	29.3
	2	53.8	53.0	51.6	49.7	47.2	44.1	40.1	34.9	28.3
	3	52.8	52.0	50.6	48.7	46.2	43.1	39.1	33.9	27.3
	4	51.8	51.0	49.6	47.7	45.2	42.1	38.1	32.9	26.3
	5*	50.8	50.0	48.6	46.7	44.2	41.1	37.1	-	-
	6*	49.8	49.0	47.6	45.7	43.2	40.1	36.1	-	-
	7*	48.8	48.0	46.6	44.7	42.2	39.1	-	-	-
	8*	47.8	47.0	45.6	43.7	-	-	-	-	-

Note: Depending on the pump model, the maximum suction depth varies between 7.5 and 8.5 m.

* Only available in O-version

** Only available in S-version

CM 5

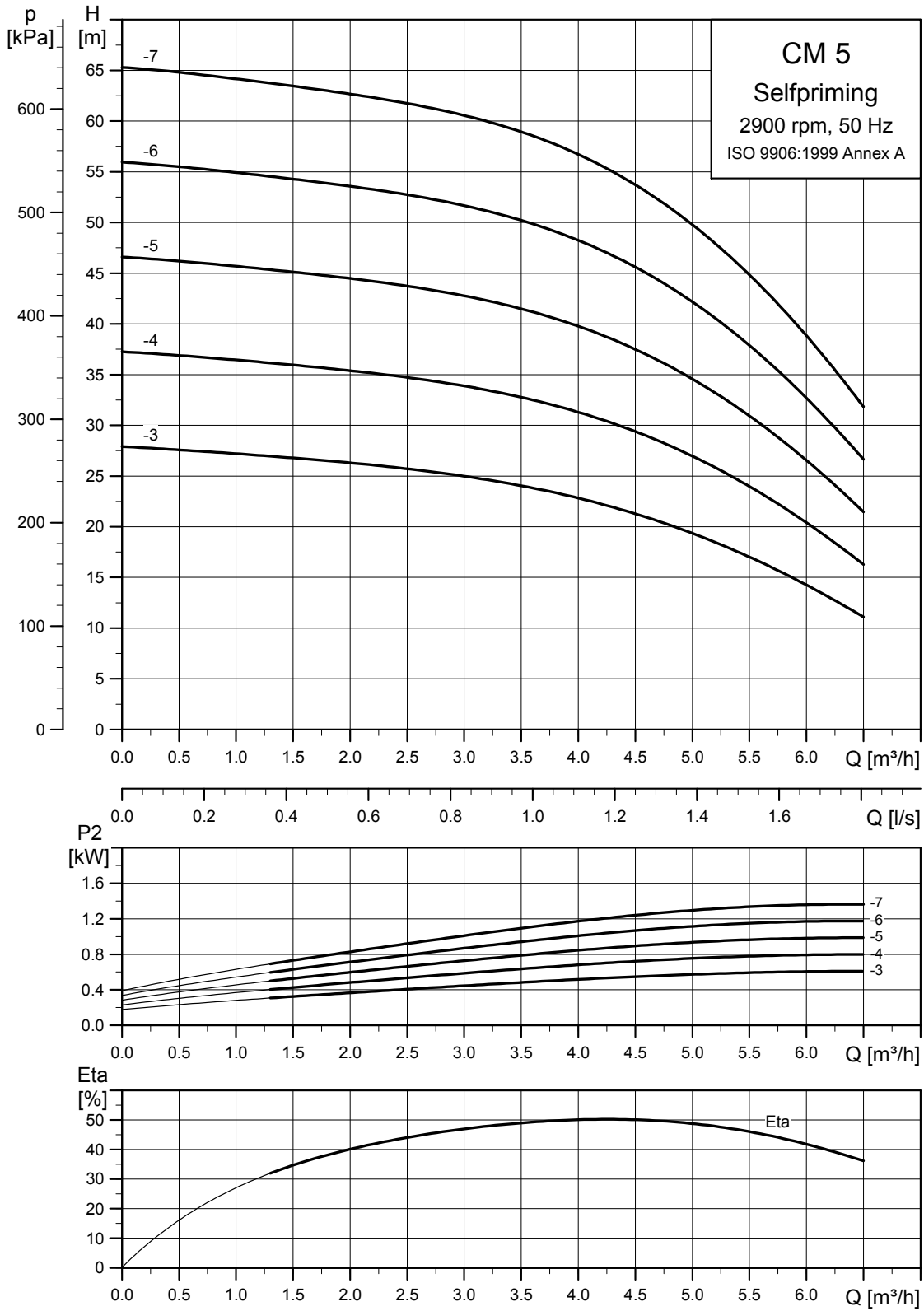

Note: Pump performance is influenced by the suction lift. See page 21.

TM05 8758 2713

Pump performance in relation to suction lift

CM 5-3

Pump head [m]	Flow [m ³ /h]														
	0	0.5	1	1.5	2	2.5	3	3.5	4	4.5	5	5.5**	6**	6.5**	
Suction lift [m]	0	27.9	27.6	27.2	26.8	26.3	25.7	25.0	24.0	22.8	21.3	19.4	17.0	14.3	11.1
	1	26.9	26.6	26.2	25.8	25.3	24.7	24.0	23.0	21.8	20.3	18.4	16.0	13.3	10.1
	2	25.9	25.6	25.2	24.8	24.3	23.7	23.0	22.0	20.8	19.3	17.4	15.0	12.3	-
	3	24.9	24.6	24.2	23.8	23.3	22.7	22.0	21.0	19.8	18.3	16.4	-	-	-
	4	23.9	23.6	23.2	22.8	22.3	21.7	21.0	20.0	18.8	17.3	-	-	-	-
	5*	22.9	22.6	22.2	21.8	21.3	20.7	20.0	19.0	17.8	-	-	-	-	-
	6*	21.9	21.6	21.2	20.8	20.3	19.7	19.0	-	-	-	-	-	-	-
	7*	20.9	20.6	20.2	19.8	19.3	-	-	-	-	-	-	-	-	-
	8*	19.9	19.6	19.2	18.8	-	-	-	-	-	-	-	-	-	-

CM 5-4

Pump head [m]	Flow [m ³ /h]														
	0	0.5	1	1.5	2	2.5	3	3.5	4	4.5	5	5.5**	6**	6.5**	
Suction lift [m]	0	37.3	36.9	36.4	35.9	35.4	34.7	33.9	32.8	31.3	29.4	27.0	24.0	20.4	16.3
	1	36.3	35.9	35.4	34.9	34.4	33.7	32.9	31.8	30.3	28.4	26.0	23.0	19.4	15.3
	2	35.3	34.9	34.4	33.9	33.4	32.7	31.9	30.8	29.3	27.4	25.0	22.0	18.4	-
	3	34.3	33.9	33.4	32.9	32.4	31.7	30.9	29.8	28.3	26.4	24.0	-	-	-
	4	33.3	32.9	32.4	31.9	31.4	30.7	29.9	28.8	27.3	25.4	-	-	-	-
	5*	32.3	31.9	31.4	30.9	30.4	29.7	28.9	27.8	26.3	-	-	-	-	-
	6*	31.3	30.9	30.4	29.9	29.4	28.7	27.9	-	-	-	-	-	-	-
	7*	30.3	29.9	29.4	28.9	28.4	-	-	-	-	-	-	-	-	-
	8*	29.3	28.9	28.4	27.9	-	-	-	-	-	-	-	-	-	-

CM 5-5

Pump head [m]	Flow [m ³ /h]														
	0	0.5	1	1.5	2	2.5	3	3.5	4	4.5	5	5.5**	6**	6.5**	
Suction lift [m]	0	46.6	46.2	45.7	45.1	44.5	43.7	42.8	41.5	39.8	37.5	34.6	30.9	26.5	21.5
	1	45.6	45.2	44.7	44.1	43.5	42.7	41.8	40.5	38.8	36.5	33.6	29.9	25.5	20.5
	2	44.6	44.2	43.7	43.1	42.5	41.7	40.8	39.5	37.8	35.5	32.6	28.9	24.5	-
	3	43.6	43.2	42.7	42.1	41.5	40.7	39.8	38.5	36.8	34.5	31.6	-	-	-
	4	42.6	42.2	41.7	41.1	40.5	39.7	38.8	37.5	35.8	33.5	-	-	-	-
	5*	41.6	41.2	40.7	40.1	39.5	38.7	37.8	36.5	34.8	-	-	-	-	-
	6*	40.6	40.2	39.7	39.1	38.5	37.7	36.8	-	-	-	-	-	-	-
	7*	39.6	39.2	38.7	38.1	37.5	-	-	-	-	-	-	-	-	-
	8*	38.6	38.2	37.7	37.1	-	-	-	-	-	-	-	-	-	-

CM 5-6

Pump head [m]	Flow [m ³ /h]														
	0	0.5	1	1.5	2	2.5	3	3.5	4	4.5	5	5.5**	6**	6.5**	
Suction lift [m]	0	55.9	55.5	54.9	54.3	53.6	52.7	51.7	50.2	48.2	45.6	42.2	37.9	32.7	26.6
	1	54.9	54.5	53.9	53.3	52.6	51.7	50.7	49.2	47.2	44.6	41.2	36.9	31.7	25.6
	2	53.9	53.5	52.9	52.3	51.6	50.7	49.7	48.2	46.2	43.6	40.2	35.9	30.7	-
	3	52.9	52.5	51.9	51.3	50.6	49.7	48.7	47.2	45.2	42.6	39.2	-	-	-
	4	51.9	51.5	50.9	50.3	49.6	48.7	47.7	46.2	44.2	41.6	-	-	-	-
	5*	50.9	50.5	49.9	49.3	48.6	47.7	46.7	45.2	43.2	-	-	-	-	-
	6*	49.9	49.5	48.9	48.3	47.6	46.7	45.7	-	-	-	-	-	-	-
	7*	48.9	48.5	47.9	47.3	46.6	-	-	-	-	-	-	-	-	-
	8*	47.9	47.5	46.9	46.3	-	-	-	-	-	-	-	-	-	-

Note: Depending on the pump model, the maximum suction depth varies between 7.5 and 8.5 m.

* Only available in O-version

** Only available in S-version

CM 5-7

Pump head [m]	Flow [m ³ /h]													
	0	0.5	1	1.5	2	2.5	3	3.5	4	4.5	5	5.5**	6**	6.5**
0	65.3	64.8	64.2	63.4	62.7	61.7	60.6	58.9	56.7	53.7	49.8	44.8	38.8	31.1
1	64.3	63.8	63.2	62.4	61.7	60.7	59.6	57.9	55.7	52.7	48.8	43.8	37.8	30.1
2	63.3	62.8	62.2	61.4	60.7	59.7	58.6	56.9	54.7	51.7	47.8	42.8	36.8	-
3	62.3	61.8	61.2	60.4	59.7	58.7	57.6	55.9	53.7	50.7	46.8	-	-	-
4	61.3	60.8	60.2	59.4	58.7	57.7	56.6	54.9	52.7	49.7	-	-	-	-
5*	60.3	59.8	59.2	58.4	57.7	56.7	55.6	53.9	51.7	-	-	-	-	-
6*	59.3	58.8	58.2	57.4	56.7	55.7	54.6	-	-	-	-	-	-	-
7*	58.3	57.8	57.2	56.4	55.7	-	-	-	-	-	-	-	-	-
8*	57.3	56.8	56.2	55.4	-	-	-	-	-	-	-	-	-	-

Note: Depending on the pump model, the maximum suction depth varies between 7.5 and 8.5 m.

* Only available in O-version

** Only available in S-version

13. Performance curves, CM, 60 Hz

CM 1

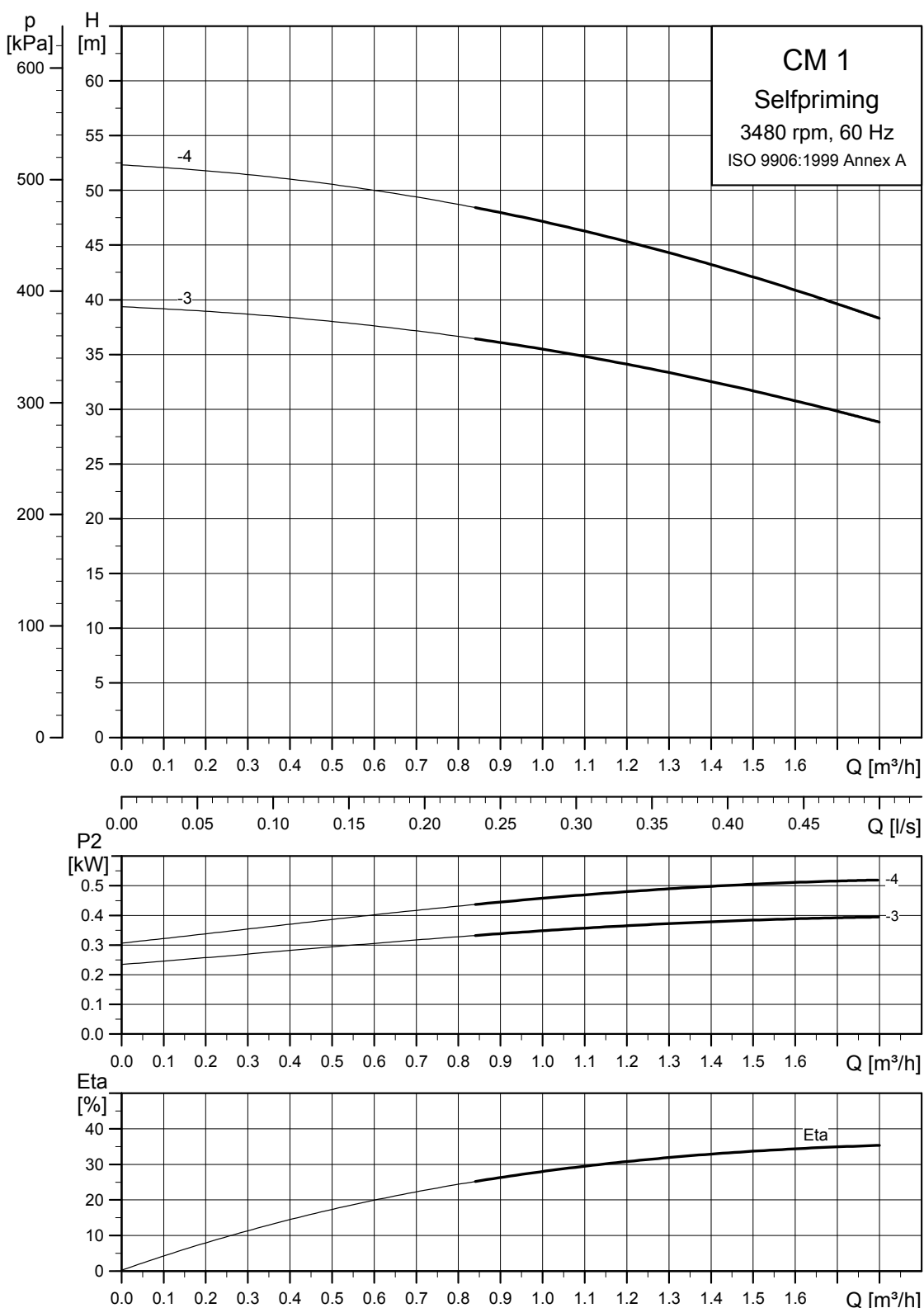

Note: Pump performance is influenced by the suction lift. See page 25.

TM05 8793 2713

Pump performance in relation to suction lift

CM 1-3

Pump head [m]		Flow [m ³ /h]										
		0	0.25	0.5	0.75	1	1.25	1.5	1.75	2	2.25	2.5
Suction lift [m]	0	39.4	38.8	38.0	36.9	35.5	33.7	31.7	29.3	26.7	23.8	20.8
	1	38.4	37.8	37.0	35.9	34.5	32.7	30.7	28.3	25.7	22.8	19.8
	2	37.4	36.8	36.0	34.9	33.5	31.7	29.7	27.3	24.7	21.8	18.8
	3	36.4	35.8	35.0	33.9	32.5	30.7	28.7	26.3	23.7	20.8	17.8
	4	35.4	34.8	34.0	32.9	31.5	29.7	27.7	25.3	22.7	19.8	16.8

CM 1-4

Pump head [m]		Flow [m ³ /h]										
		0	0.25	0.5	0.75	1	1.25	1.5	1.75	2	2.25	2.5
Suction lift [m]	0	52.3	51.6	50.5	49.1	47.2	44.8	42.1	39.0	35.5	31.7	27.7
	1	51.3	50.6	49.5	48.1	46.2	43.8	41.1	38.0	34.5	30.7	26.7
	2	50.3	49.6	48.5	47.1	45.2	42.8	40.1	37.0	33.5	29.7	25.7
	3	49.3	48.6	47.5	46.1	44.2	41.8	39.1	36.0	32.5	28.7	24.7
	4	48.3	47.6	46.5	45.1	43.2	40.8	38.1	35.0	31.5	27.7	23.7

CM 3

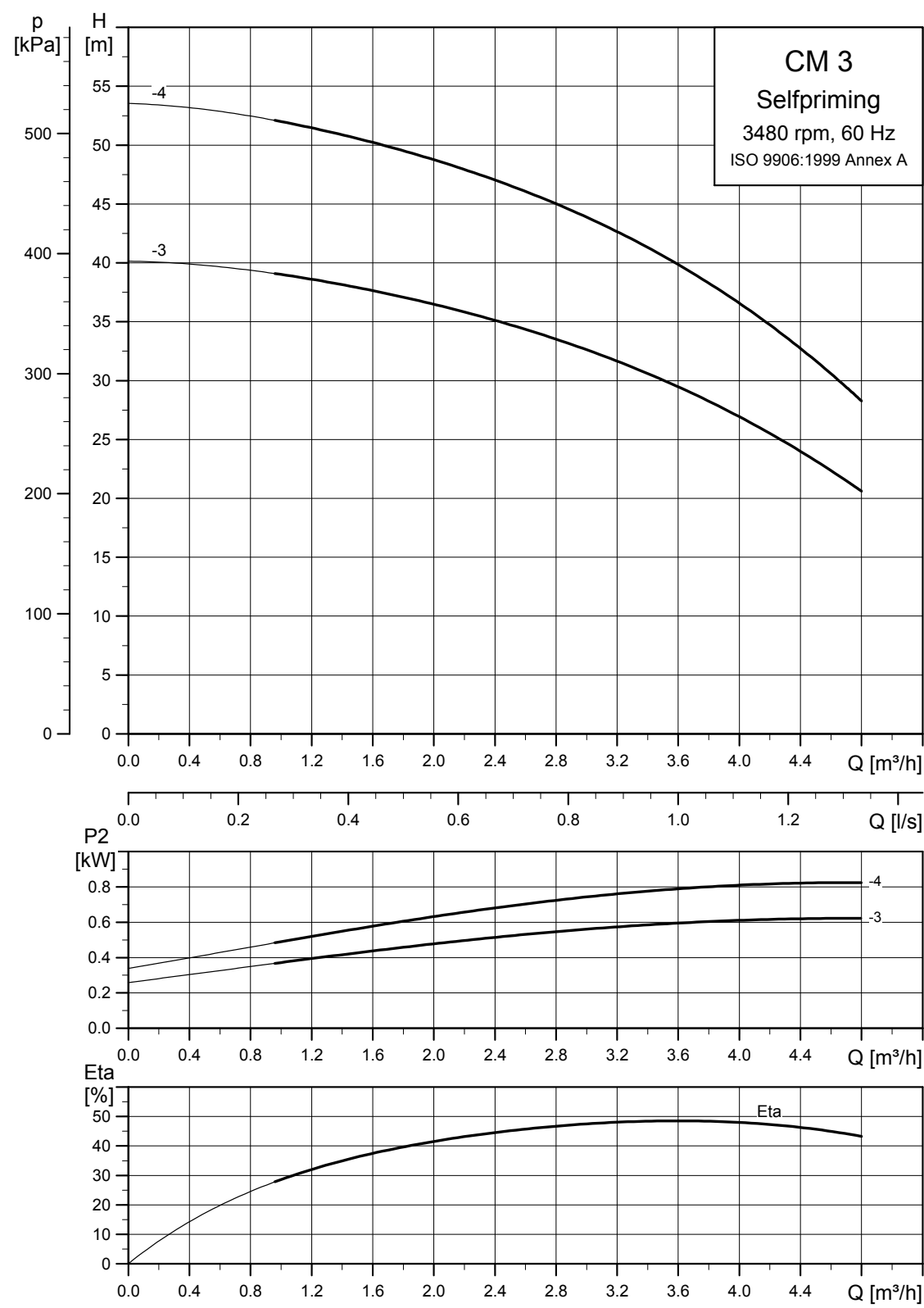

Note: Pump performance is influenced by the suction lift. See page 27.

TM05 8794 2713

Pump performance in relation to suction lift

CM 3-3

Pump head [m]	Flow [m ³ /h]											
	0	0.5	1	1.5	2	2.5	3	3.5	4**	4.5**	5**	
Suction lift [m]	0	40.1	39.8	39.0	37.9	36.5	34.7	32.6	30.1	26.9	23.2	18.7
	1	39.1	38.8	38.0	36.9	35.5	33.7	31.6	29.1	25.9	22.2	17.7
	2	38.1	37.8	37.0	35.9	34.5	32.7	30.6	28.1	24.9	21.2	16.7
	3	37.1	36.8	36.0	34.9	33.5	31.7	29.6	27.1	23.9	20.2	-
	4	36.1	35.8	35.0	33.9	32.5	30.7	28.6	26.1	22.9	-	-
	5*	35.1	34.8	34.0	32.9	31.5	29.7	27.6	-	-	-	-
	6*	34.1	33.8	33.0	31.9	30.5	28.7	26.6	-	-	-	-
	7*	33.1	32.8	32.0	30.9	29.5	27.7	-	-	-	-	-
	8*	32.1	31.8	31.0	29.9	-	-	-	-	-	-	-

CM 3-4

Pump head [m]	Flow [m ³ /h]											
	0	0.5	1	1.5	2	2.5	3	3.5	4**	4.5**	5**	
Suction lift [m]	0	53.5	53.0	52.0	50.6	48.8	46.6	43.9	40.6	36.6	31.7	25.8
	1	52.5	52.0	51.0	49.6	47.8	45.6	42.9	39.6	35.6	30.7	24.8
	2	51.5	51.0	50.0	48.6	46.8	44.6	41.9	38.6	34.6	29.7	23.8
	3	50.5	50.0	49.0	47.6	45.8	43.6	40.9	37.6	33.6	28.7	-
	4	49.5	49.0	48.0	46.6	44.8	42.6	39.9	36.6	32.6	-	-
	5*	48.5	48.0	47.0	45.6	43.8	41.6	38.9	-	-	-	-
	6*	47.5	47.0	46.0	44.6	42.8	40.6	37.9	-	-	-	-
	7*	46.5	46.0	45.0	43.6	41.8	39.6	-	-	-	-	-
	8*	45.5	45.0	44.0	42.6	-	-	-	-	-	-	-

Note: Depending on the pump model, the maximum suction depth varies between 7.5 and 8.5 m.

* Only available in O-version

** Only available in S-version

CM 5

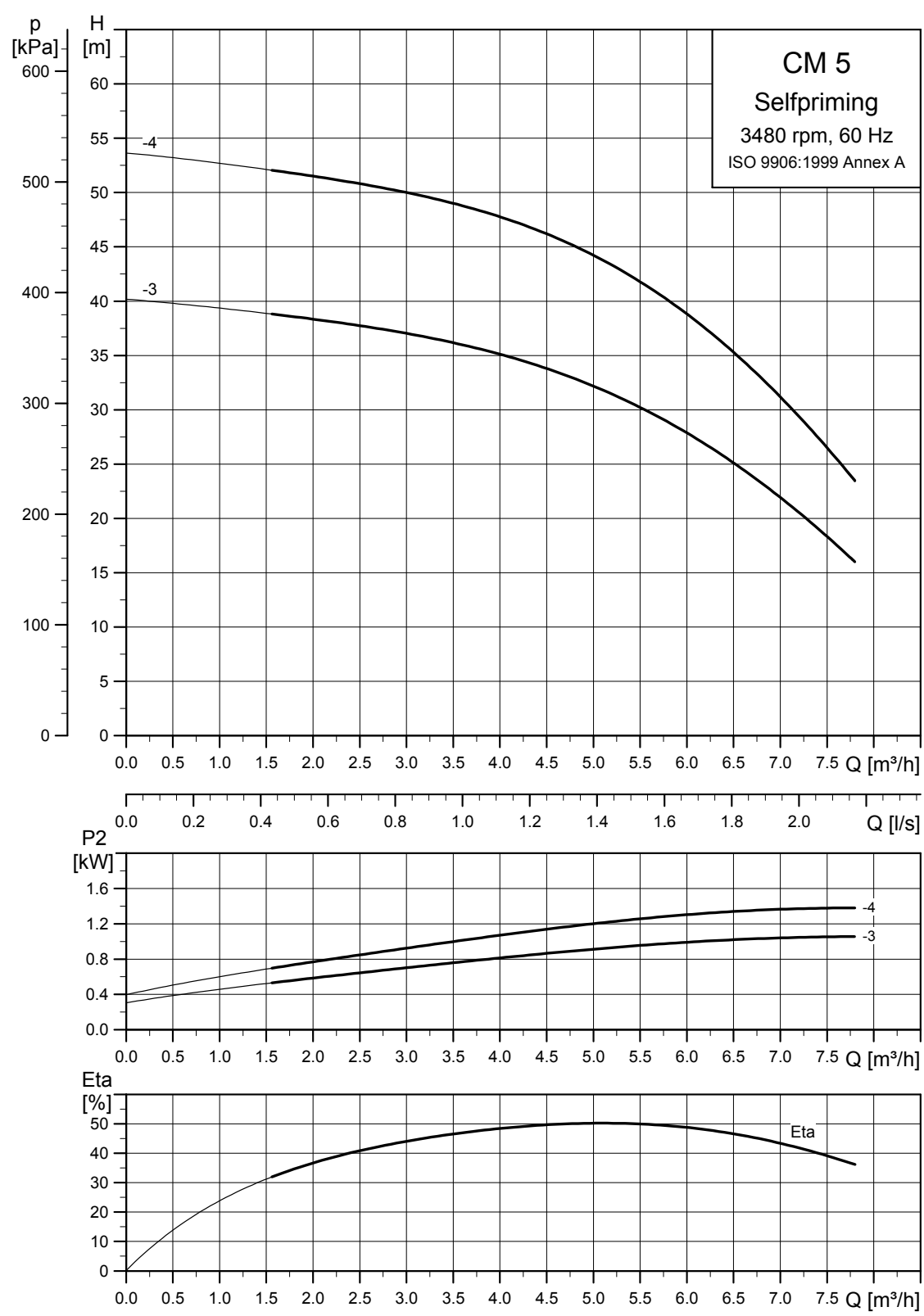

Note: Pump performance is influenced by the suction lift. See page 29.

TM05 8795 2713

Pump performance in relation to suction lift

CM 5-3

Pump head [m]		Flow [m ³ /h]															
		0	0.5	1	1.5	2	2.5	3	3.5	4	4.5	5	5.5	6	6.5**	7**	7.5**
Suction lift [m]	0	40.2	39.8	39.4	38.9	38.3	37.7	37.0	36.2	35.1	33.8	32.2	30.2	27.9	25.1	21.9	18.3
	1	39.2	38.8	38.4	37.9	37.3	36.7	36.0	35.2	34.1	32.8	31.2	29.2	26.9	24.1	-	-
	2	38.2	37.8	37.4	36.9	36.3	35.7	35.0	34.2	33.1	31.8	30.2	28.2	25.9	-	-	-
	3	37.2	36.8	36.4	35.9	35.3	34.7	34.0	33.2	32.1	30.8	29.2	-	-	-	-	-
	4	36.2	35.8	35.4	34.9	34.3	33.7	33.0	32.2	31.1	29.8	-	-	-	-	-	-
	5*	35.2	34.8	34.4	33.9	33.3	32.7	32.0	31.2	30.1	-	-	-	-	-	-	-
	6*	34.2	33.8	33.4	32.9	32.3	31.7	31.0	-	-	-	-	-	-	-	-	-
	7*	33.2	32.8	32.4	31.9	31.3	-	-	-	-	-	-	-	-	-	-	-
	8*	32.2	31.8	31.4	30.9	-	-	-	-	-	-	-	-	-	-	-	-

CM 5-4

Pump head [m]		Flow [m ³ /h]															
		0	0.5	1	1.5	2	2.5	3	3.5	4	4.5	5	5.5	6	6.5**	7**	7.5**
Suction lift [m]	0	53.6	53.2	52.7	52.1	51.5	50.8	50.0	49.0	47.8	46.2	44.2	41.8	38.8	35.3	31.2	26.5
	1	52.6	52.2	51.7	51.1	50.5	49.8	49.0	48.0	46.8	45.2	43.2	40.8	37.8	34.3	-	-
	2	51.6	51.2	50.7	50.1	49.5	48.8	48.0	47.0	45.8	44.2	42.2	39.8	36.8	-	-	-
	3	50.6	50.2	49.7	49.1	48.5	47.8	47.0	46.0	44.8	43.2	41.2	-	-	-	-	-
	4	49.6	49.2	48.7	48.1	47.5	46.8	46.0	45.0	43.8	42.2	-	-	-	-	-	-
	5*	48.6	48.2	47.7	47.1	46.5	45.8	45.0	44.0	42.8	-	-	-	-	-	-	-
	6*	47.6	47.2	46.7	46.1	45.5	44.8	44.0	-	-	-	-	-	-	-	-	-
	7*	46.6	46.2	45.7	45.1	44.5	-	-	-	-	-	-	-	-	-	-	-
	8*	45.6	45.2	44.7	44.1	-	-	-	-	-	-	-	-	-	-	-	-

Note: Depending on the pump model, the maximum suction depth varies between 7.5 and 8.5 m.

* Only available in O-version

** Only available in S-version

14. Dimensions

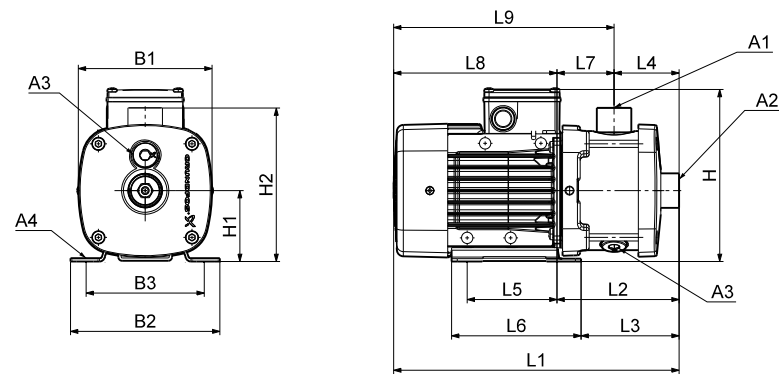

TM04 2246 2208

1 x 220-240 V, 50 Hz (supply voltage C)

Pump type	Frame size	P ₂ [kW]	Dimensions [mm]																		
			A1	A2	A3	A4	B1	B2	B3	H	H1	H2	L1	L2	L3	L4	L5	L6	L7	L8	L9
CM 1-3	71A	0.3	1"	1"	3/8"	10	142	158	125	208	75	165	377	203	179	144	96	137	60	174	234
CM 1-4	71B	0.5	1"	1"	3/8"	10	142	158	125	208	75	165	377	203	179	144	96	137	60	174	234
CM 1-5	71B	0.5	1"	1"	3/8"	10	142	158	125	208	75	165	413	239	215	180	96	137	60	174	234
CM 1-6	71B	0.5	1"	1"	3/8"	10	142	158	125	208	75	165	413	239	215	180	96	137	60	174	234
CM 3-3	71B	0.5	1"	1"	3/8"	10	142	158	125	208	75	165	377	203	179	144	96	137	60	174	234
CM 3-4	71B	0.5	1"	1"	3/8"	10	142	158	125	208	75	165	377	203	179	144	96	137	60	174	234
CM 3-5	71B	0.5	1"	1"	3/8"	10	142	158	125	208	75	165	413	239	215	180	96	137	60	174	234
CM 3-6	80A	0.67	1"	1"	3/8"	10	142	158	125	208	75	165	453	239	215	180	96	137	60	214	274
CM 5-3	71B	0.5	1"	1"	3/8"	10	142	158	125	208	75	165	377	203	179	144	96	137	60	174	234
CM 5-4	80A	0.67	1"	1"	3/8"	10	142	158	125	208	75	165	417	203	179	144	96	137	60	214	274
CM 5-5	80B	0.9	1"	1"	3/8"	10	142	158	125	208	75	165	453	239	215	180	96	137	60	214	274
CM 5-6	90SA	1.3	1"	1"	3/8"	10	178	178	140	229	90	180	503	279	264	180	125	155	99	224	323
CM 5-7	90SA	1.3	1"	1"	3/8"	10	178	178	140	229	90	180	539	315	300	216	125	155	99	224	323

1 x 220 V, 60 Hz (supply voltage A)

Pump type	Frame size	P ₂ [kW]	Dimensions [mm]																		
			A1	A2	A3	A4	B1	B2	B3	H	H1	H2	L1	L2	L3	L4	L5	L6	L7	L8	L9
CM 1-3	71B	0.6	1"	1"	3/8"	10	142	158	125	208	75	165	377	203	179	144	96	137	60	174	234
CM 1-4	71B	0.6	1"	1"	3/8"	10	142	158	125	208	75	165	377	203	179	144	96	137	60	174	234
CM 3-3	71B	0.6	1"	1"	3/8"	10	142	158	125	208	75	165	377	203	179	144	96	137	60	174	234
CM 3-4	80A	0.84	1"	1"	3/8"	10	142	158	125	208	75	165	417	203	179	144	96	137	60	214	274
CM 5-3	80B	1.14	1"	1"	3/8"	10	205	158	125	208	75	165	417	203	179	144	96	137	60	214	274
CM 5-4	90SB	1.54	1"	1"	3/8"	10	178	178	140	229	90	180	467	243	228	144	125	155	99	224	323

All dimensions are in mm unless otherwise stated.

15. Weights and shipping volume

All weights and volumes refer to CM(E) pumps with standard pipe connections.

CM 1-I

(I = EN 1.4301/AISI 304)

Supply voltage	Pump type	Net weight [kg]	Gross weight [kg]	Shipping volume [m ³]
1 x 220-240 V, 50 Hz (supply voltage C)	CM 1-3	11.7	14.2	0.02
	CM 1-4	12.7	15.2	0.02
	CM 1-5	13.1	15.6	0.02
	CM 1-6	13.7	16.2	0.03
1 x 220 V, 60 Hz (supply voltage A)	CM 1-3	11.7	14.2	0.02
	CM 1-4	12.0	14.5	0.02

CM 3-I

(I = EN 1.4301/AISI 304)

Supply voltage	Pump type	Net weight [kg]	Gross weight [kg]	Shipping volume [m ³]
1 x 220-240 V, 50 Hz (supply voltage C)	CM 3-3	12.4	14.9	0.02
	CM 3-4	12.7	15.2	0.02
	CM 3-5	13.1	15.6	0.02
	CM 3-6	15.1	17.6	0.03
1 x 220 V, 60 Hz (supply voltage A)	CM 3-3	11.7	14.2	0.02
	CM 3-4	12.0	14.5	0.02

CM 5-I

(I = EN 1.4301/AISI 304)

Supply voltage	Pump type	Net weight [kg]	Gross weight [kg]	Shipping volume [m ³]
1 x 220-240 V, 50 Hz (supply voltage C)	CM 5-3	12.4	14.9	0.02
	CM 5-4	14.1	16.6	0.03
	CM 5-5	15.5	18.0	0.03
	CM 5-6	21.8	24.3	0.04
	CM 5-7	21.9	24.4	0.04
1 x 220 V, 60 Hz (supply voltage A)	CM 5-3	12.4	14.9	0.02
	CM 5-4	15.5	18.0	0.03

16. Motor data

Mains-operated motors, 50 Hz

1 x 220-240 V, 50 Hz (supply voltage C)

Frame size	P ₂ [kW]	I _{1/1} [A]	cos φ _{1/1}	η [%]	I _{start} [A]	Speed [min ⁻¹]
71A	0.3	1.8 - 2.4	0.95 - 0.86	67.4 - 61.4	6.1 - 8.2	2.800 - 2.830
71B	0.5	3.1 - 2.8	0.97 - 0.99	74 - 70	16.4 - 14.8	2.730 - 2.740
80A	0.67	4.4 - 4.0	0.99 - 0.99	71.8 - 73	17.2 - 15.6	2.720 - 2.800
80B	0.9	5.4 - 5.0	0.98 - 0.98	76 - 74	23.2 - 21.5	2.750 - 2.790
90SA	1.3	8.4 - 8.0	0.98 - 0.98	71 - 71	28.6 - 27.2	2.710 - 2.710

Mains-operated motors, 60 Hz

1 x 220 V, 60 Hz (supply voltage A)

Frame size	P ₂		Service factor	I _{1/1} [A]	Service factor current	cos φ _{1/1}	η [%]	I _{start} [A]	Speed [min ⁻¹]
	[kW]	[hp]							
71B	0.60	0.80	1	4.1	4.1	0.98	71	16.8	3.300
80A	0.84	1.1	1	5.8	5.8	0.98	69.8	18.6	3.150
80B	1.14	1.5	1	7.35	7.35	0.99	73.5	19.8	3.270
90SB	1.54	2.0	1	9.8	9.8	0.98	74.8	37.2	3.330

17. Further product information

WebCAPS

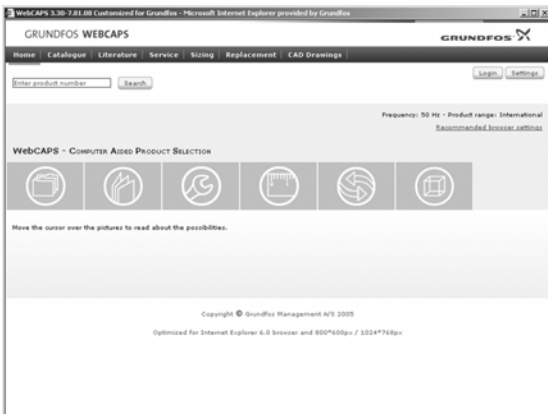

WebCAPS is a **Web-based Computer Aided Product Selection** program available on www.grundfos.com.

WebCAPS contains detailed information on more than 220,000 Grundfos products in more than 30 languages.

Information in WebCAPS is divided into six sections:

- Catalogue
- Literature
- Service
- Sizing
- Replacement
- CAD drawings.

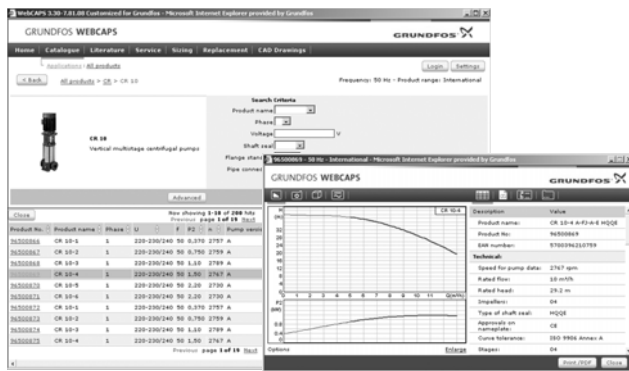

Catalogue

Based on fields of application and pump types, this section contains the following:

- technical data
- curves (QH, Eta, P1, P2, etc.) which can be adapted to the density and viscosity of the pumped liquid and show the number of pumps in operation
- product photos
- dimensional drawings
- wiring diagrams
- quotation texts, etc.

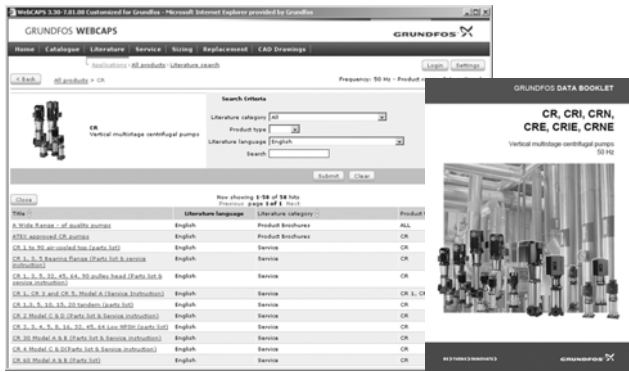

Literature

This section contains all the latest documents of a given pump, such as

- data booklets
- installation and operating instructions
- service documentation, such as Service kit catalogue and Service kit instructions
- quick guides
- product brochures.



Service

This section contains an easy-to-use interactive service catalogue. Here you can find and identify service parts of both existing and discontinued Grundfos pumps.

Furthermore, the section contains service videos showing you how to replace service parts.



Sizing

This section is based on different fields of application and installation examples and gives easy step-by-step instructions in how to size a product:

- Select the most suitable and efficient pump for your installation.
- Carry out advanced calculations based on energy, consumption, payback periods, load profiles, life cycle costs, etc.
- Analyse your selected pump via the built-in life cycle cost tool.
- Determine the flow velocity in wastewater applications, etc.



Replacement

In this section you find a guide to selecting and comparing replacement data of an installed pump in order to replace the pump with a more efficient Grundfos pump. The section contains replacement data of a wide range of pumps produced by other manufacturers than Grundfos.

Based on an easy step-by-step guide, you can compare Grundfos pumps with the one you have installed on your site. When you have specified the installed pump, the guide will suggest a number of Grundfos pumps which can improve both comfort and efficiency.

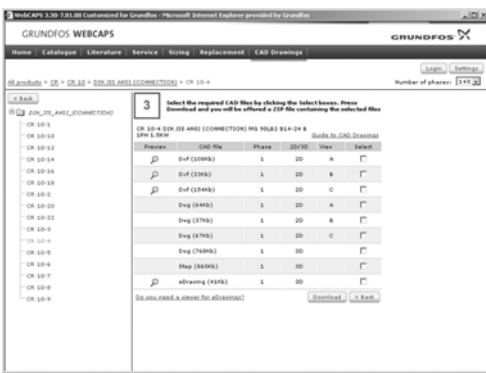

CAD drawings

In this section, it is possible to download 2-dimensional (2D) and 3-dimensional (3D) CAD drawings of most Grundfos pumps.

These formats are available in WebCAPS:

- 2-dimensional drawings:
- .dxf, wireframe drawings
 - .dwg, wireframe drawings.
- 3-dimensional drawings:
- .dwg, wireframe drawings (without surfaces)
 - .stp, solid drawings (with surfaces)
 - .eprt, E-drawings.

WinCAPS



Fig. 13 WinCAPS DVD

WinCAPS is a **Windows-based Computer Aided Product Selection** program containing detailed information on more than 220,000 Grundfos products in more than 30 languages.

The program contains the same features and functions as WebCAPS, but is an ideal solution if no internet connection is available.

WinCAPS is available on DVD and updated once a year.

GO CAPS

Mobile solution for professionals on the GO!



CAPS functionality on the mobile workplace.



Subject to alterations.

98514505 1013

ECM: 1121556

GRUNDFOS A/S
DK-8850 Bjerringbro . Denmark
Telephone: +45 87 50 14 00
www.grundfos.com

GRUNDFOS 